

**KRYETARI I BASHKISË**

**NURI BELBA**

**PROJEKT ZBATIMI**

**ASFALTIM I RRUGËS SË LAGJES SË RE (DEGËZIMI I TOROMANIT), PRRENJAS FSHAT**

**BASHKIA PRRENJAS**

**PROJEKTUES:**

**ING. KASTRIOT BEGAJ**

 Digitally signed by  
Kastriot Begaj  
Date: 2023.10.10  
08:30:33 +02'00'







PLANIMETRIA DHE IZOIPSET  
SH 1 : 1000

MIRATOHET:  
KRYETARI I BASHKISE  
NURI BELBA

PROFILI GJATSOR I PJERRSISE SE RRUGES SH VERTIKALE 1:500  
SHKALLA HORIZONTALE 1: 1000

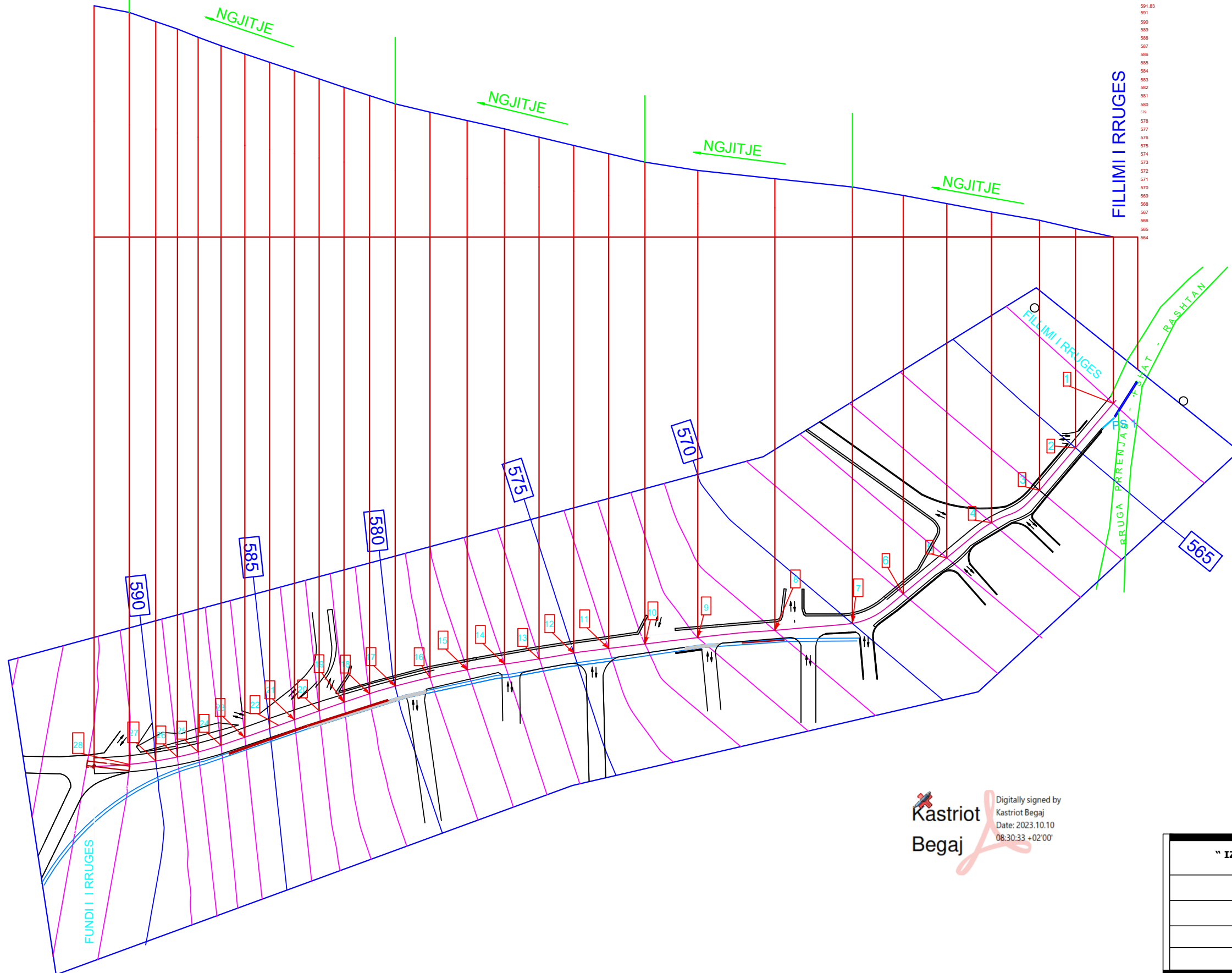

Kastriot  
Begaj

Digitally signed by  
Kastriot Begaj  
Date: 2023.10.10  
08:30:33 +02'00'

" IZOIPSET DHE PROFIL GJATSOR I PJERRSISE SE RRUGES"	
ING. KASTRIOT BEGAJ NR LIC. K. 0546/4	
ARK. GERTI BEGAJ	
BASHKIA PRRNJAS	
BASHKIA PRRNJAS	
Cel : 0682016010, 0692118661, 0695400070	

# MURET DHE ARMIMET

MIRATOHET:  
KRYETARI I BASHKISE  
NURI BELBA

Digitally signed by Nuri  
Belba  
Date: 2023.10.10  
09:49:06 +02'00'

Belba

L = 20 m

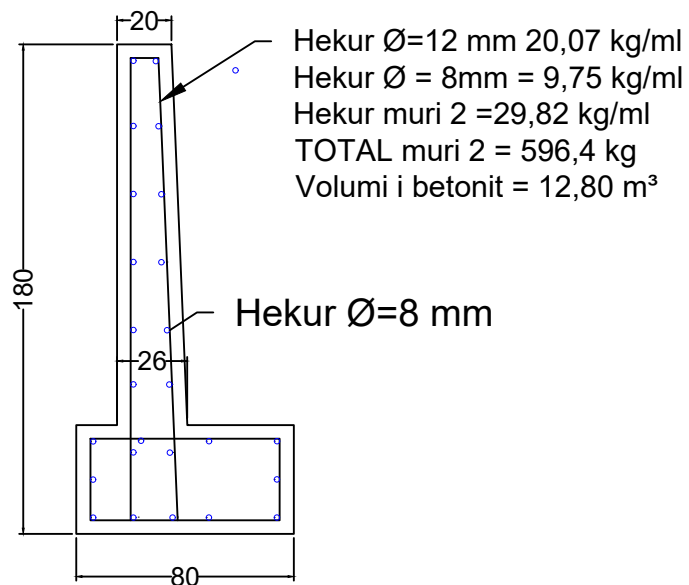

L = 20 m

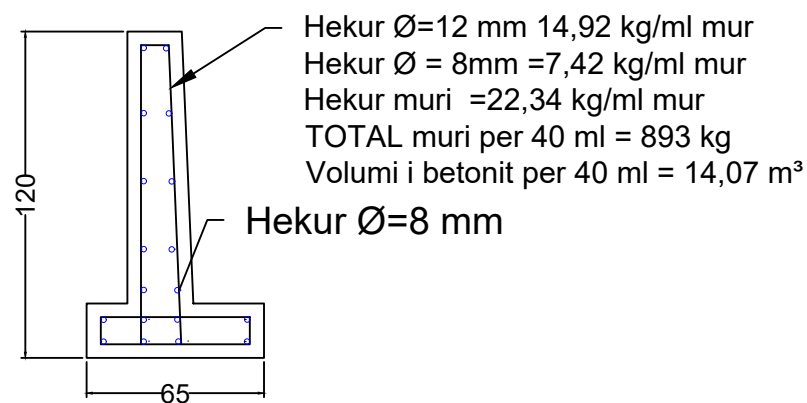

Digitally signed by  
Kastriot Begaj  
Date: 2023.10.10  
08:30:33 +02'00'

Kastriot  
Begaj

## DETAJE NDRICIMI RRUGA RASHTAN

PROJEKTOI:	ING. KASTRIOT BEGAJ NR LIC. K. 0546/4	
PERPUNOI:	ARK. GERTI BEGAJ	
PRANOI:	BASHKIA PRENJAS	
INVESTITOR:	BASHKIA PRENJAS	

Cel : 0682016010, 0692118661, 0695400070



MIRATOHET:  
KRYETARI I BASHKISE  
NURI BELBA

AZHORNIMI TOPOGRAFIK  
SHKALLA 1 : 1000

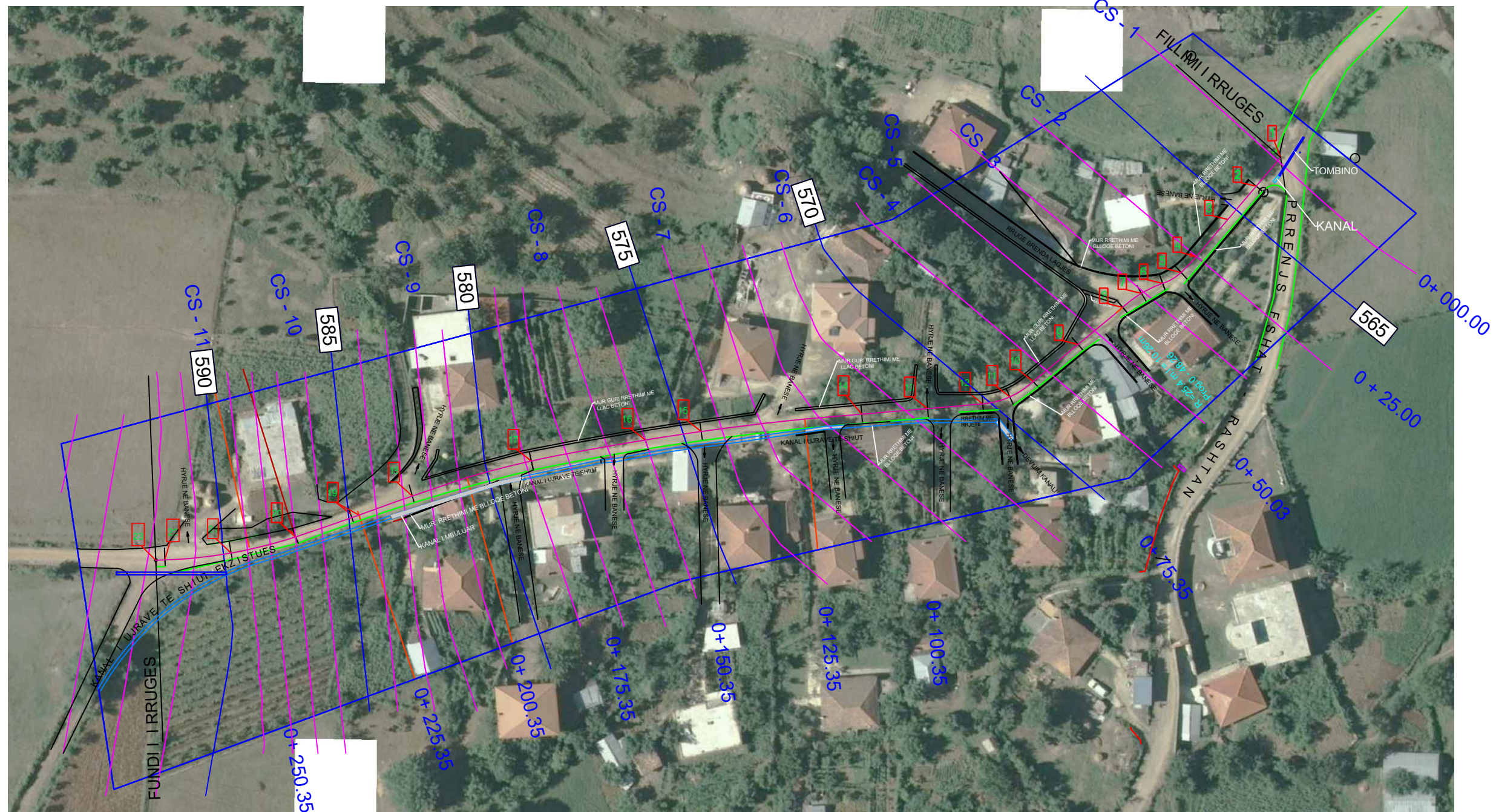

SHPJEGUES:

- KUFIRI I RRUGES EKZISTUESE NE JUG PRANE KANALIT
- KANAL UJRASH EKZISTUES
- TOMBINO EKZISTUESE
- 565 IZOIPSE DHE KUOTA
- CS = 11 PROFILE TERTHORE

**Kastriot**  
Begaj

Digitally signed by  
Kastriot Begaj  
Date: 2023.10.10  
08:30:33 +02'00'

"PLAN RILEVIMI I RRUGES 1:1000"	
PROJEKTOI:	ING. KASTRIOT BEGAJ NR LIC. K. 0546/4
PERPUNOI:	ARK. GERTI BEGAJ
PRANOI:	BASHKIA PPRENJAS
INVESTITOR:	<b>BASHKIA PPRENJAS</b>
Cel : 0682016010, 0692118661, 0695400070	



PLANIMETRIA ME SFOND SH 1 : 500

MIRATOHET:  
KRYETARI BASHKISE  
NURI BELBA

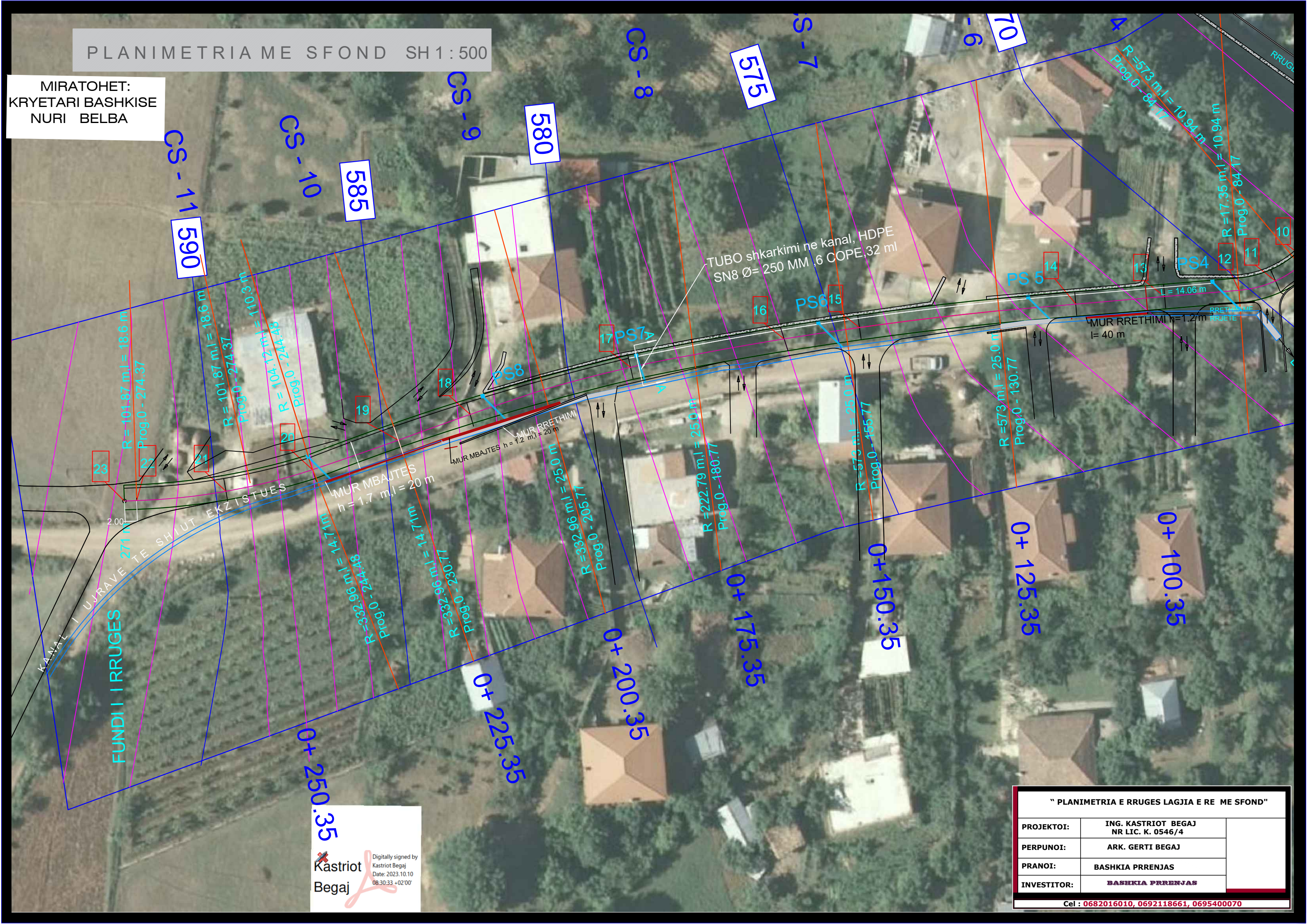

Kastriot Begaj  
Digitally signed by  
Kastriot Begaj  
Date: 2023.10.10  
08:30:33 +02'00'

" PLANIMETRIA E RRUAGES LAGJIA E RE ME SFOND"	
PROJEKTOI:	ING. KASTRIOT BEGAJ NR LIC. K. 0546/4
PERPUNOI:	ARK. GERTI BEGAJ
PRANOI:	BASHKIA PRENJAS
INVESTITOR:	BASHKIA PRENJAS
Cel : 0682016010, 0692118661, 0695400070	



SHTYLLE ELEKTRIKE ME PUSETE NE TOKE ME LIDHJE  
EKUIPOTENCIALE DHE MORSETERIA E LINJES SE NDRICIMIT  
SH K A L L A 1 : 50

MIRATOHET:  
KRYETARI I BASHKISE  
NURI BELBA

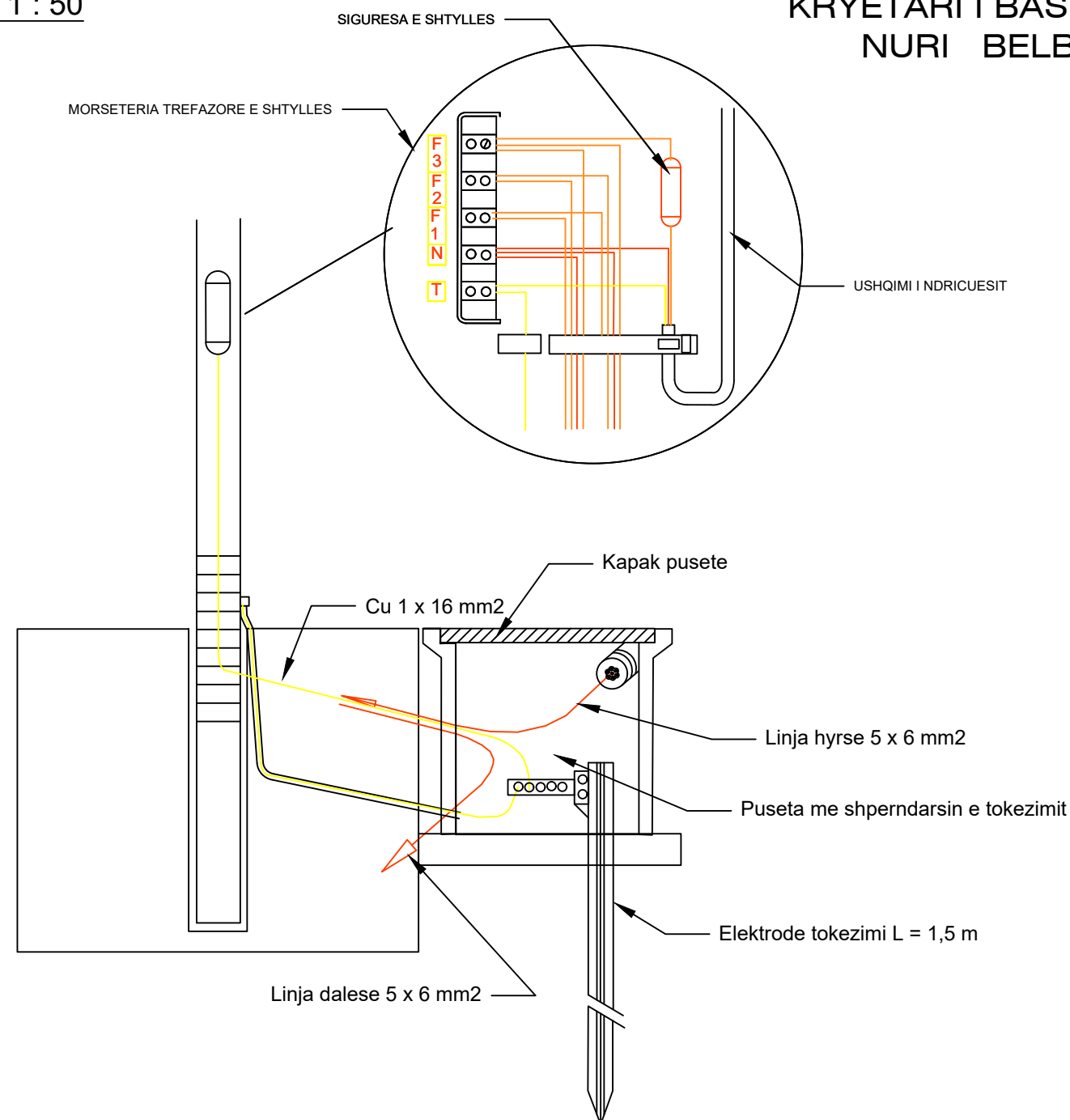
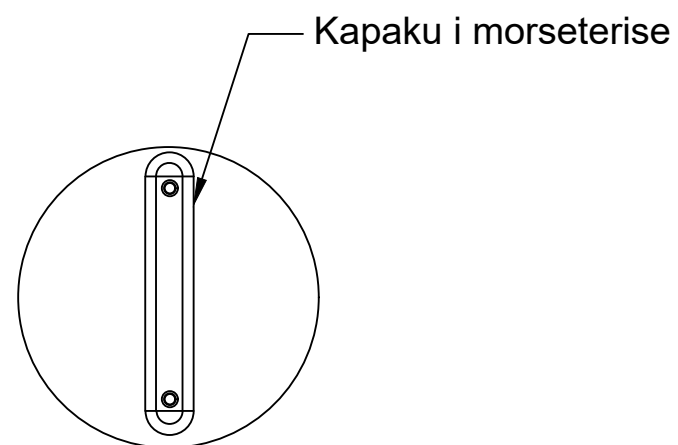
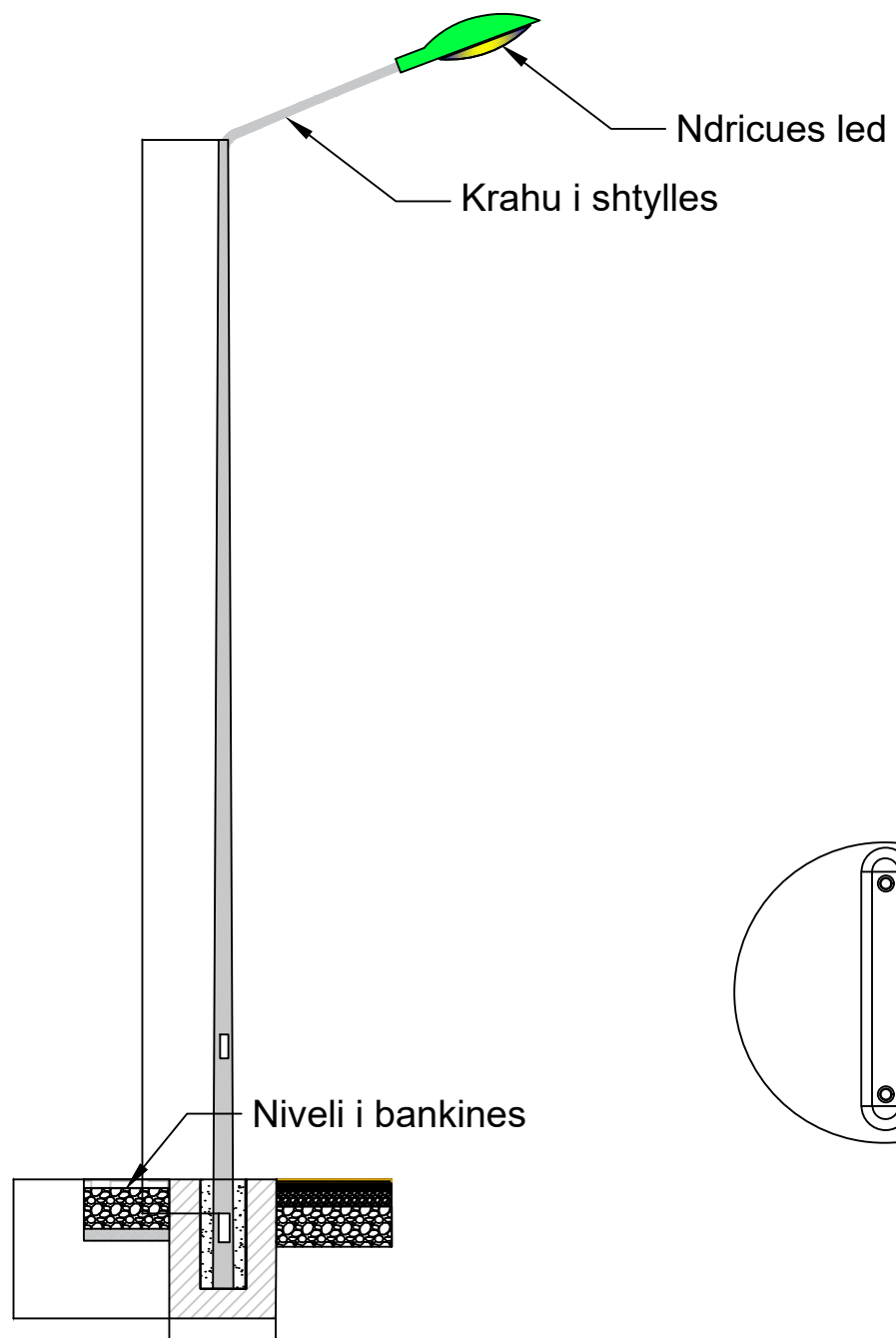

**Kastriot**  
Begaj

Digitally signed by  
Kastriot Begaj  
Date: 2023.10.10  
08:30:33 +02'00'

DETAJE NDRICIMI RRUGA RASHTAN	
PROJEKTOI:	ING. KASTRIOT BEGAJ NR LIC. K. 0546/4
PERPUNOI:	ARK. GERTI BEGAJ
PRANOI:	BASHKIA PRRNJAS
INVESTITOR:	BASHKIA PRRNJAS

Cel : 0682016010, 0692118661, 0695400070



PLANIMETRIA ME SFOND SH 1:500

MIRATOHET:  
KRYETARI BASHKISE  
NURI BELBA

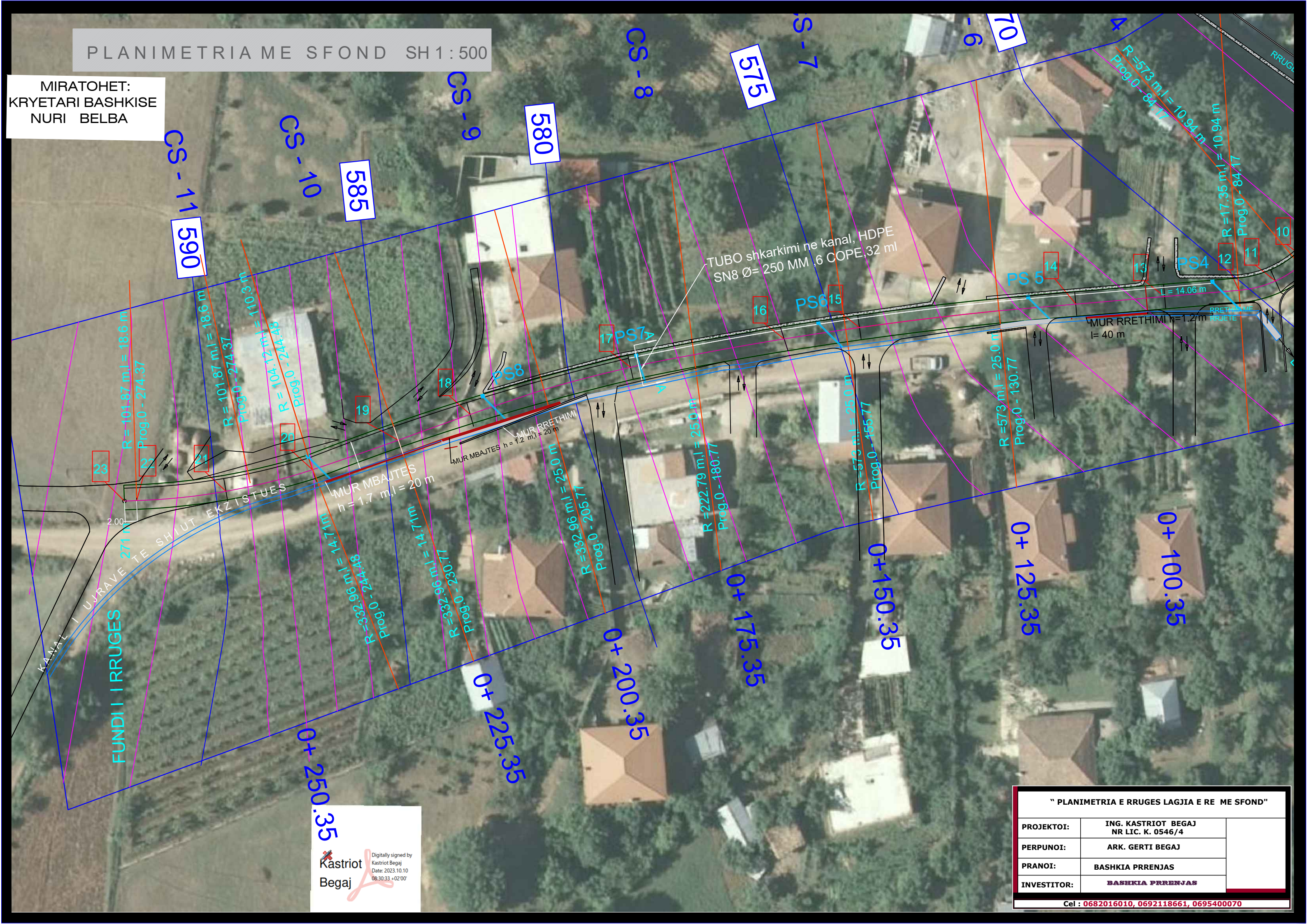

Kastriot Begaj  
Digitally signed by  
Kastriot Begaj  
Date: 2023.10.10  
08:30:33 +02'00'

" PLANIMETRIA E RRUGES LAGJIA E RE ME SFOND"	
PROJEKTOI:	ING. KASTRIOT BEGAJ NR LIC. K. 0546/4
PERPUNOI:	ARK. GERTI BEGAJ
PRANOI:	BASHKIA PRENJAS
INVESTITOR:	BASHKIA PRENJAS

Cel : 0682016010, 0692118661, 0695400070



PLANIMETRIA E ASFALTIT, NDRICIMIT DHE SINJALISTIKES SHKALLA 1 : 500

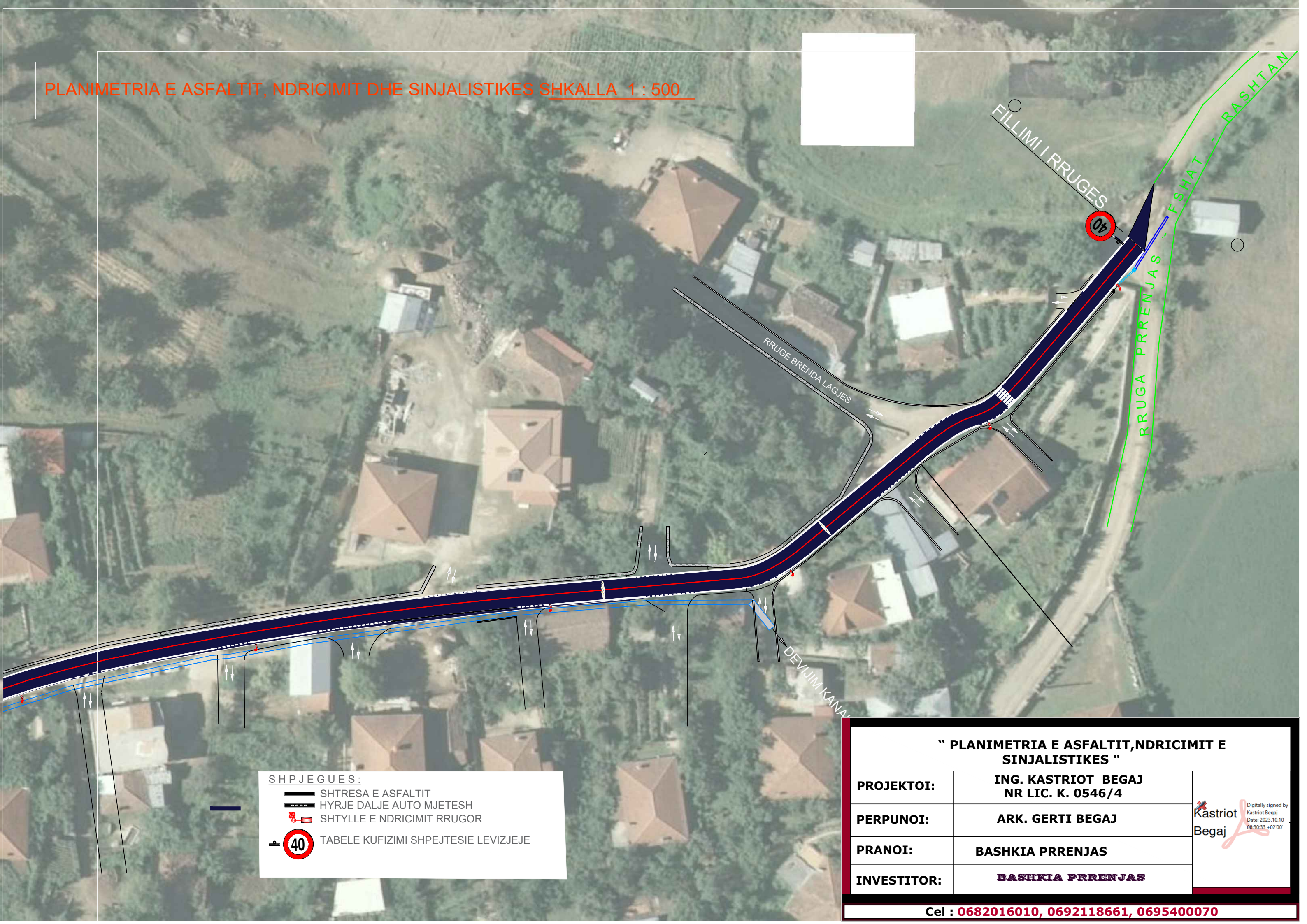

**SHPJEGUES:**

	SHTRESA E ASFALTIT
	HYRJE DALJE AUTO MJETESH
	SHTYLLE E NDRICIMIT RRUGOR
	TABELE KUFIZIMI SHPEJTESIE LEVIZJEJE

<b>" PLANIMETRIA E ASFALTIT, NDRICIMIT E SINJALISTIKES "</b>		
<b>PROJEKTOI:</b>	<b>ING. KASTRIOT BEGAJ NR LIC. K. 0546/4</b>	 Digitally signed by Kastriot Begaj Date: 2023.10.10 08:30:33 +02'00'
<b>PERPUNOI:</b>	<b>ARK. GERTI BEGAJ</b>	
<b>PRANOI:</b>	<b>BASHKIA PRRENJAS</b>	
<b>INVESTITOR:</b>	<b>BASHKIA PRRENJAS</b>	

**Cel : 0682016010, 0692118661, 0695400070**



PLANIMETRIA E ASFALTIT, NDRICIMIT DHE SINJALISTIKES, SHKALLA 1 : 500

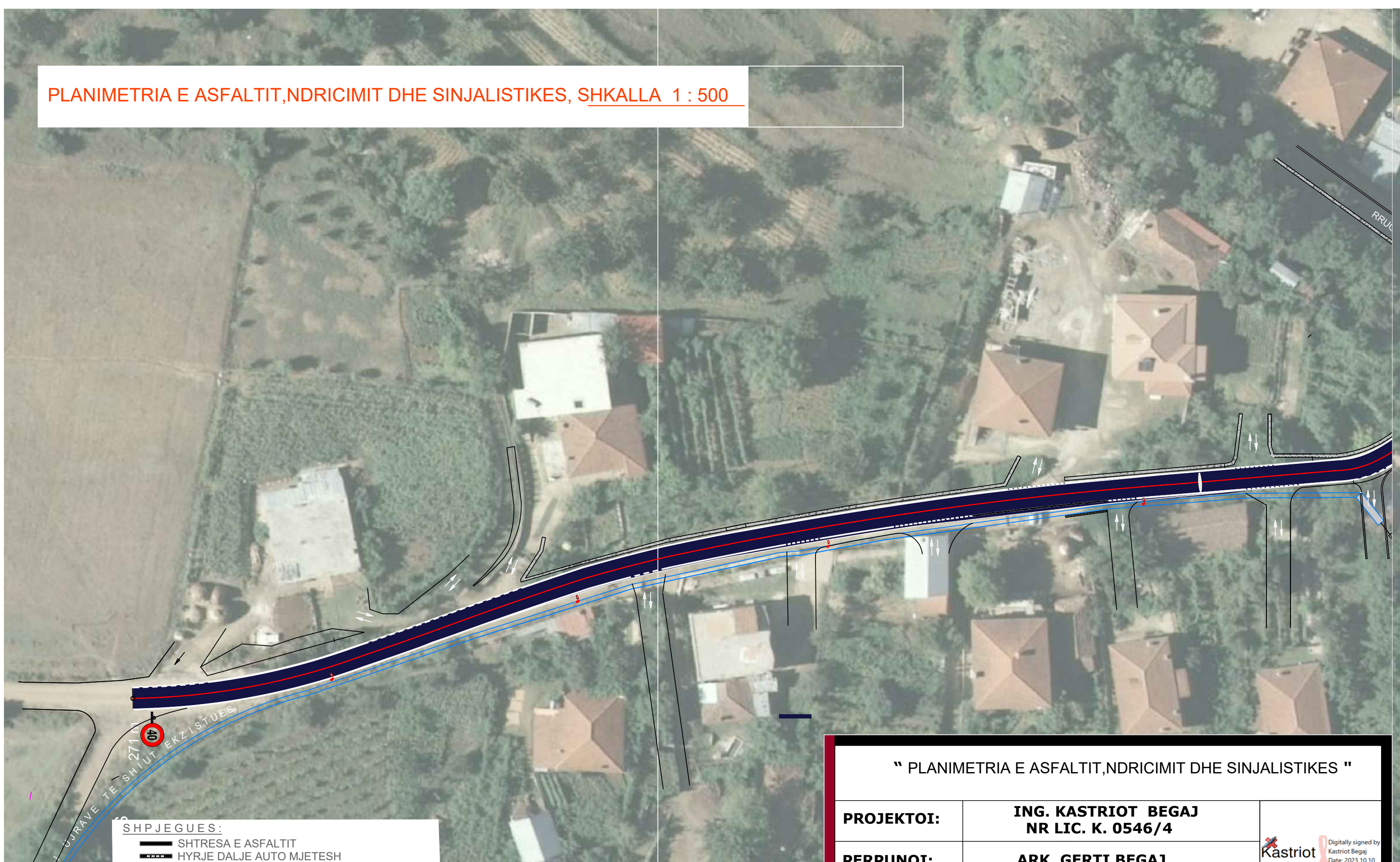

- SHPJEGUES:
- SHTRESA E ASFALTIT
  - HYRJE DALJE AUTO MJETESH
  - SHTYLLE E NDRICIMIT RRUGOR
  - TABELE KUFIZIMI SHPEJTESIE LEVIZJEJE

“ PLANIMETRIA E ASFALTIT, NDRICIMIT DHE SINJALISTIKES ”

PROJEKTOI:	ING. KASTRIOT BEGAJ NR LIC. K. 0546/4	 Digitally signed by Kastriot Begaj Date: 2023.10.10 08:30:33 +02'00'
PERPUNOI:	ARK. GERTI BEGAJ	
PRANOI:	BASHKIA PPRENJAS	
INVESTITOR:	BASHKIA PPRENJAS	

Cel : 0682016010, 0692118661, 0695400070



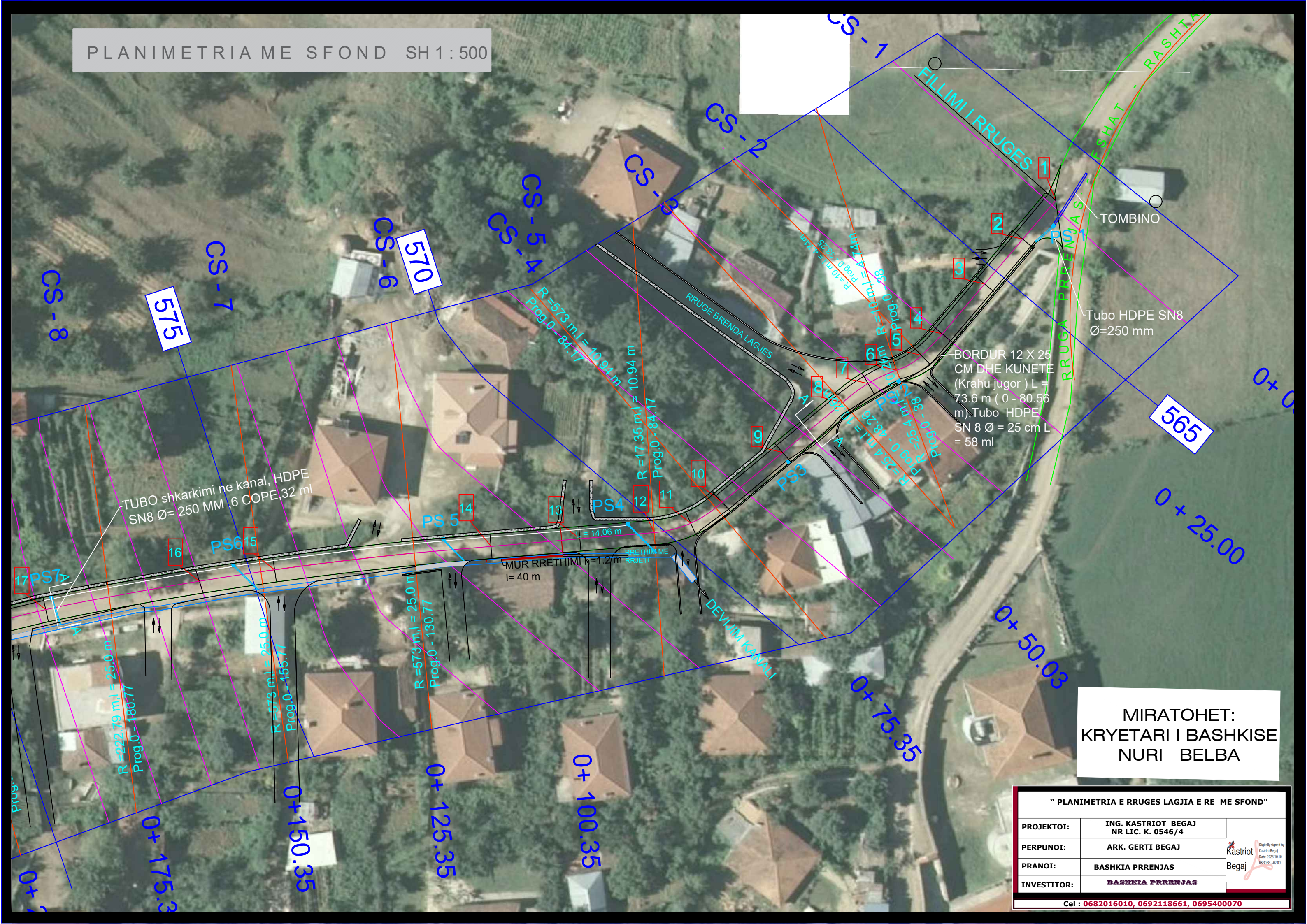

MIRATOHET:  
KRYETARI I BASHKISE  
NURI BELBA

" PLANIMETRIA E RRUGES LAGJIA E RE ME SFOND"		
PROJEKTOI:	ING. KASTRIOT BEGAJ NR LIC. K. 0546/4	
PERPUNOI:	ARK. GERTI BEGAJ	
PRANOI:	BASHKIA PRENJAS	
INVESTITOR:	BASHKIA PRENJAS	
Cel : 0682016010, 0692118661, 0695400070		



# PLANIMETRIA 2 SH 1 : 500

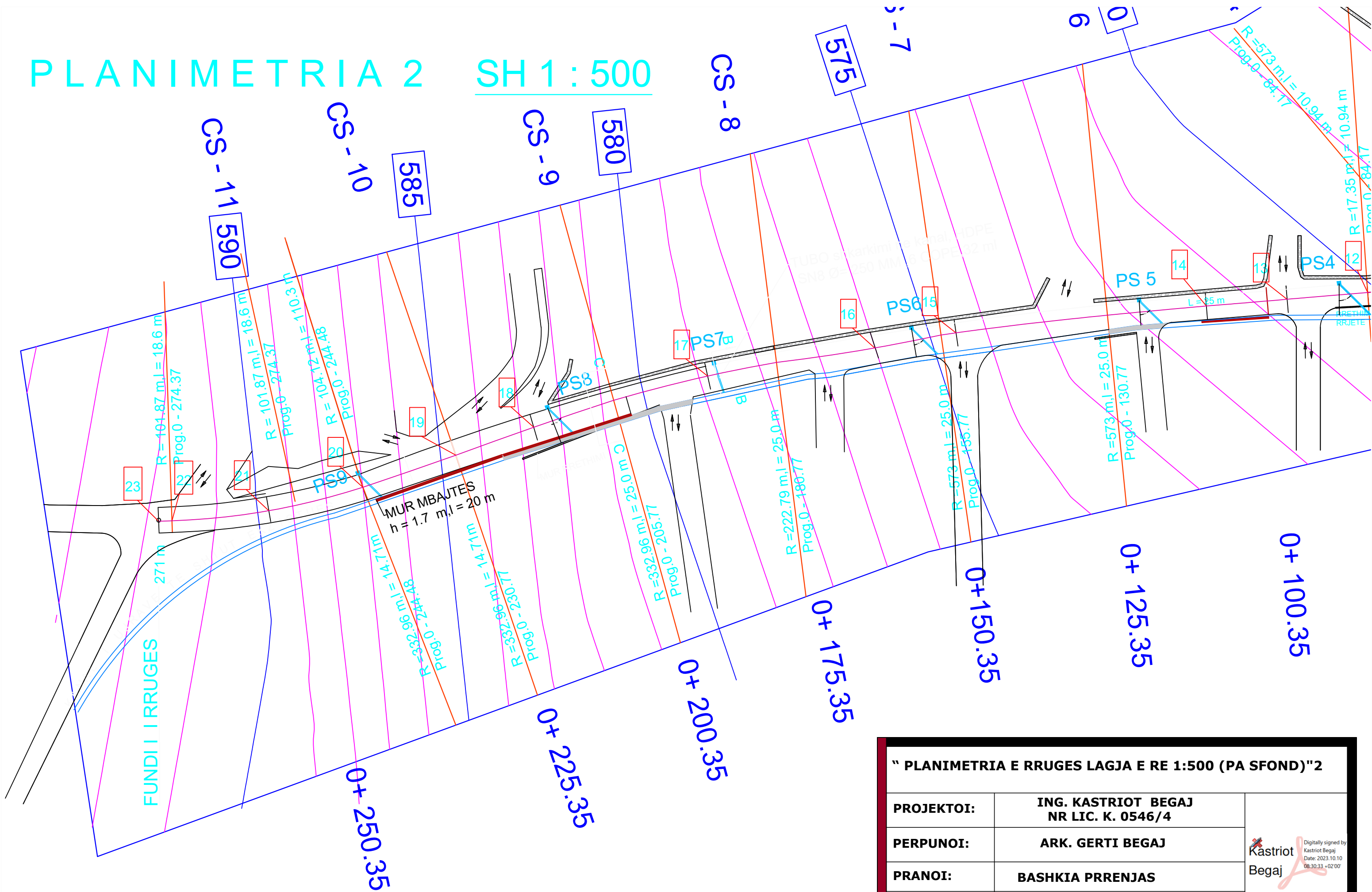

MIRATOHET:  
KRYETARI I BASHKISE  
NURI BELBA

" PLANIMETRIA E RRUGES LAGJA E RE 1:500 (PA SFOND)"2	
PROJEKTOI:	ING. KASTRIOT BEGAJ NR LIC. K. 0546/4
PERPUNOI:	ARK. GERTI BEGAJ
PRANOI:	BASHKIA PRRENJAS
INVESTITOR:	BASHKIA PRRENJAS



Digitally signed by  
Kastriot Begaj  
Date: 2023.10.10  
08:30:33 +02'00'

Cel : 0682016010, 0692118661, 0695400070



# PLANIMETRIA SH 1 : 500

MIRATOHET:  
KRYETARI I BASHKISE  
NURI BELBA

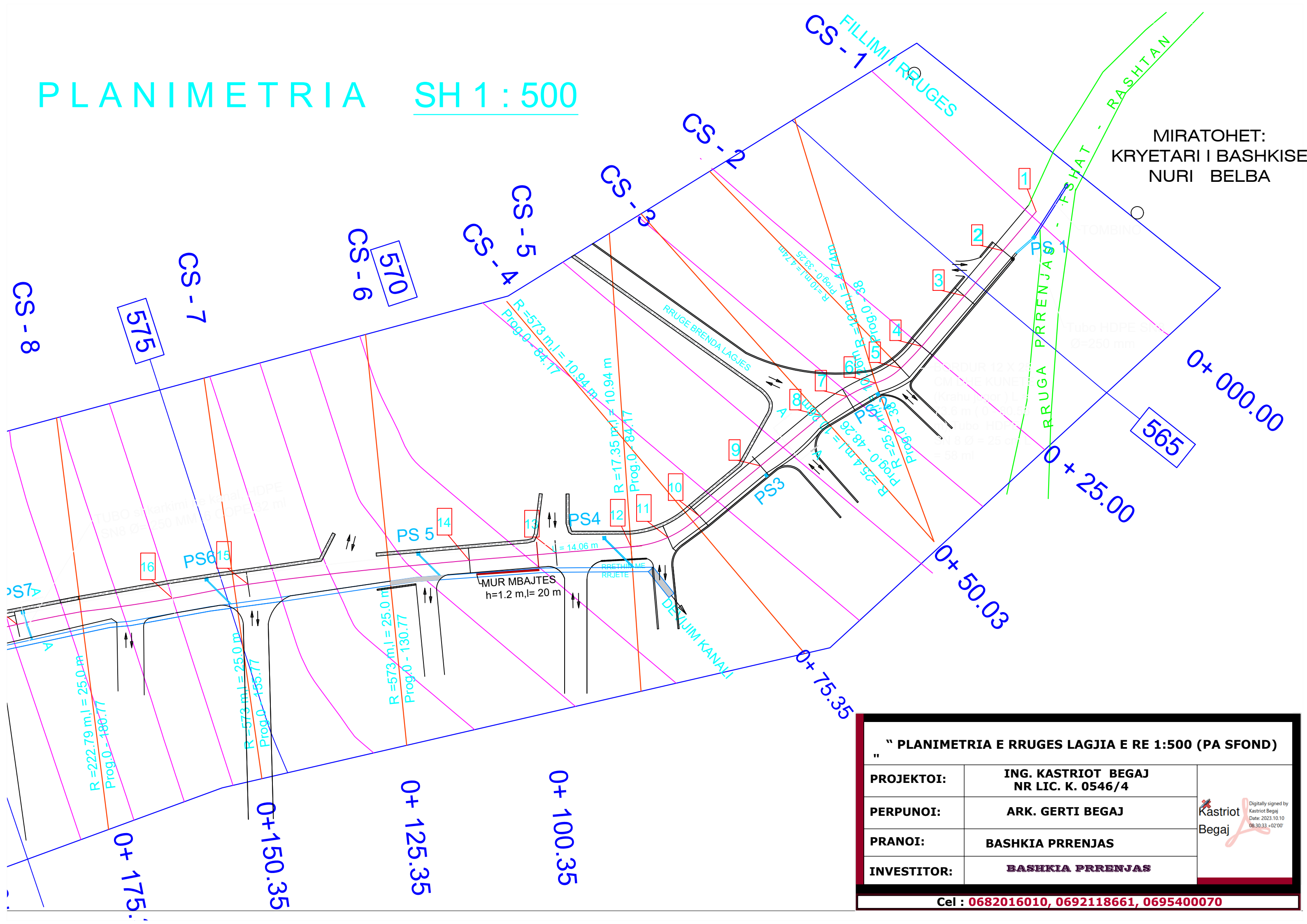

" PLANIMETRIA E RRUGES LAGJIA E RE 1:500 (PA SFOND)		
PROJEKTOI:	ING. KASTRIOT BEGAJ NR LIC. K. 0546/4	 Digitally signed by Kastriot Begaj Date: 2023.10.10 08:30:33 +0200
PERPUNOI:	ARK. GERTI BEGAJ	
PRANOI:	BASHKIA PRRENJAS	
INVESTITOR:	BASHKIA PRRENJAS	
Cel : 0682016010, 0692118661, 0695400070		



# PROFLET TERTHORE TIP TE RRUGES

## SHKALLA 1 : 40

MIRATOHET:  
KRYETARI I BASHKISE  
NURI BELBA

PROFILI TERTHOR TIP 3  
PRERJE NE AKSIN E  
PUSETES nga veriu i  
rruges.  
SH 1 : 40

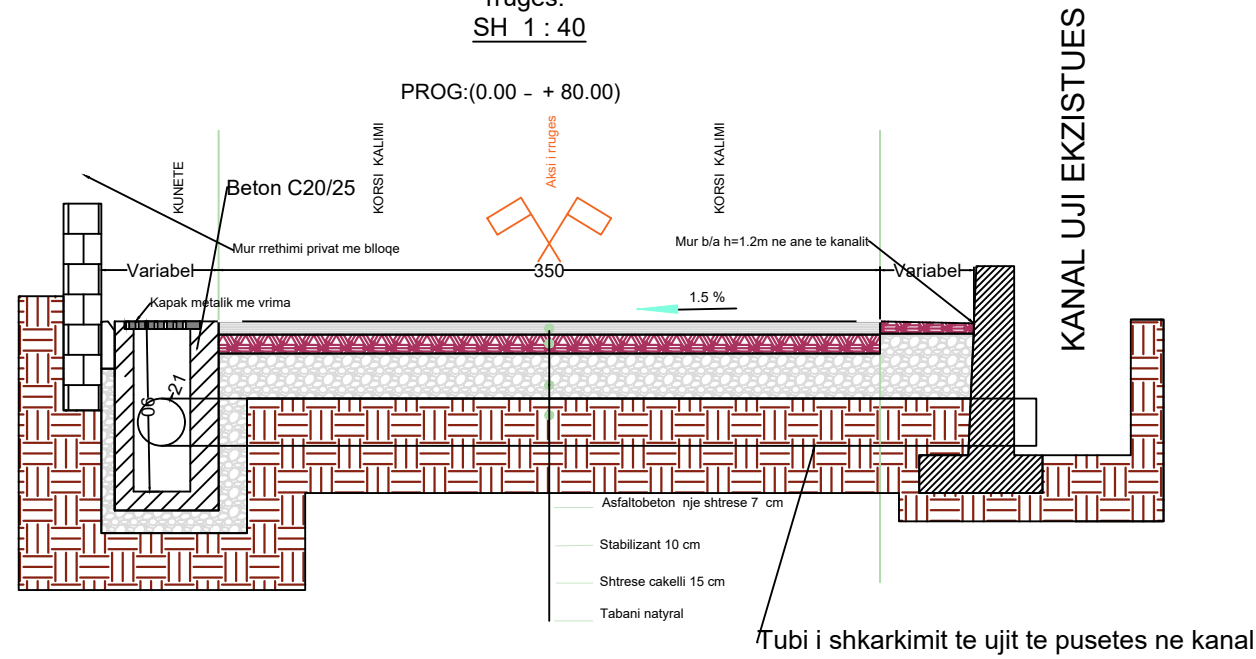

Tubi HDPE SN8 Ø 250 mm i cili ujin e pusetes e shkarkon ne kanalin ansor (jugor) te rruges, ne planin horizontal formon nje kend nga 30° deri 45° me aksin e rruges. Kjo behet sipas terrenit ku vendosen puseta dhe tubi per te lehtesuar rrjedhjen pa probleme te ujit ne kanal.

PROFILI TERTHOR TIP 4  
ne vendet pa mure ne pjesen jugore dhe ku kanali nuk  
ngushton trupin e rruges, me kuneten ne krahun e majte  
SH 1 : 40

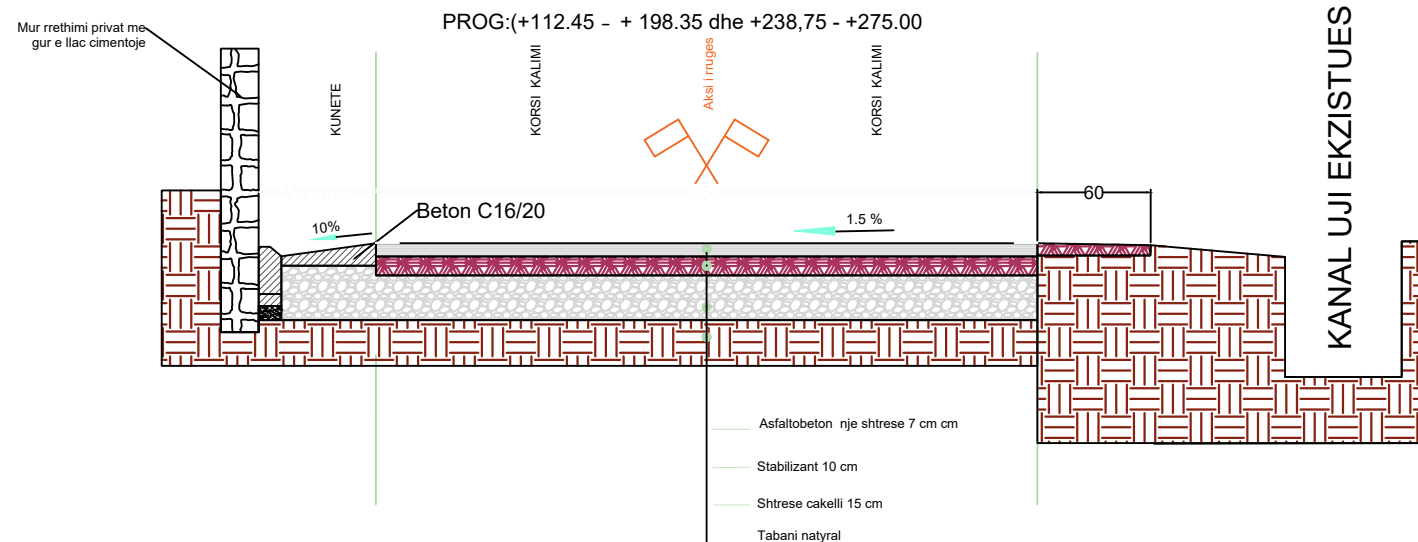

### " PROFLET TIP 3,4 "

PROJEKTOI:	ING. KASTRIOT BEGAJ NR LIC. K. 0546/4
PERPUNOI:	ARK. GERTI BEGAJ
PRANOI:	BASHKIA PRRNJAS
INVESTITOR:	BASHKIA PRRNJAS

Digitally signed by  
Kastriot Begaj  
Date: 2023.10.10  
08:30:33 +02:00

Cel : 0682016010, 0692118661, 0695400070



# PROFILET TERTHORE TIP TE RRUGES

## SHKALLA 1:40

MIRATOHET:  
KRYETARI I BASHKISE  
NURI BELBA

PROFILI TERTHOR TIP 1  
SH 1 : 40

PROG:(0.00 - + 92.00),

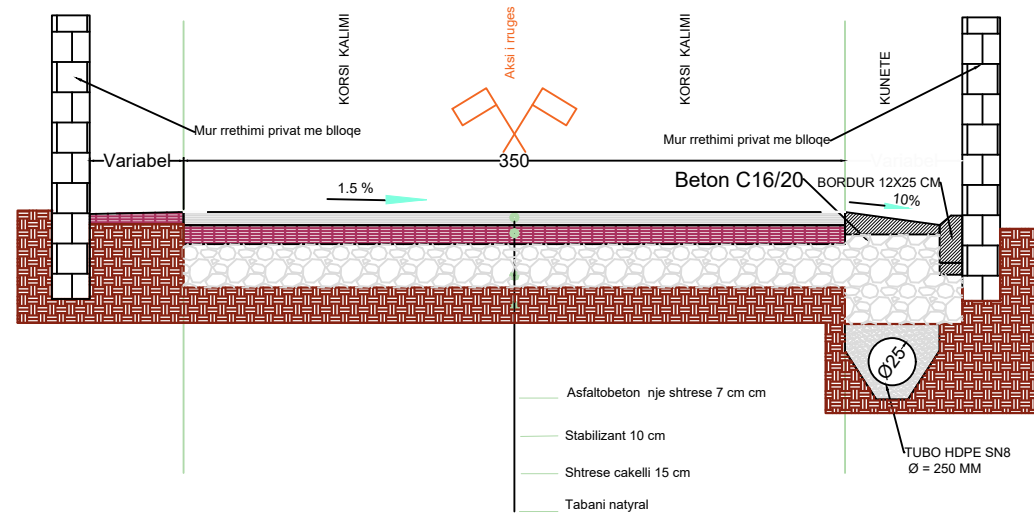

PROFILI TERTHOR TIP 1'  
PRERJE NE AKSIN E  
PUSETES

SH 1 : 40

PROG:(0.00 - + 80.00)

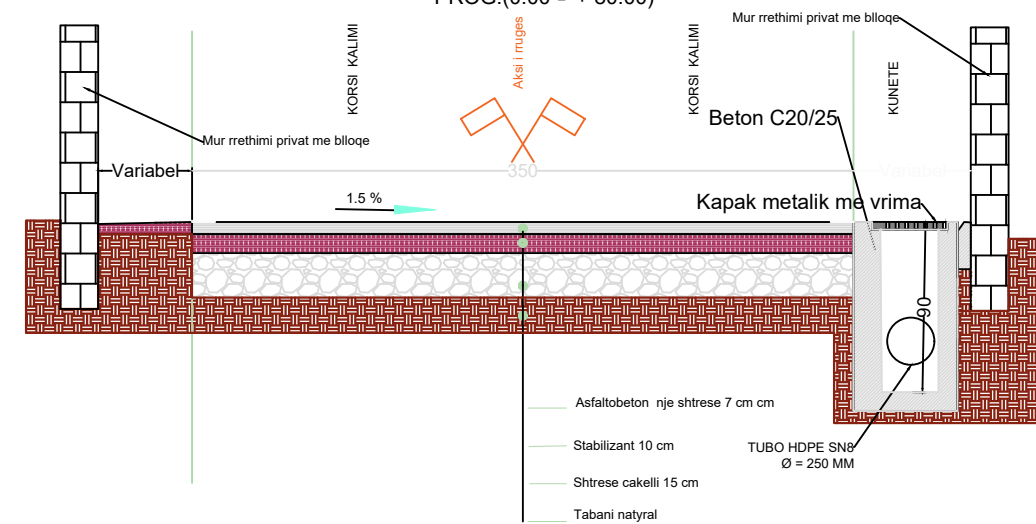

PROFILI TERTHOR TIP 2  
SH 1 : 40

PROG:(+92.00 - + 112.45 dhe +198,35 - +218.00

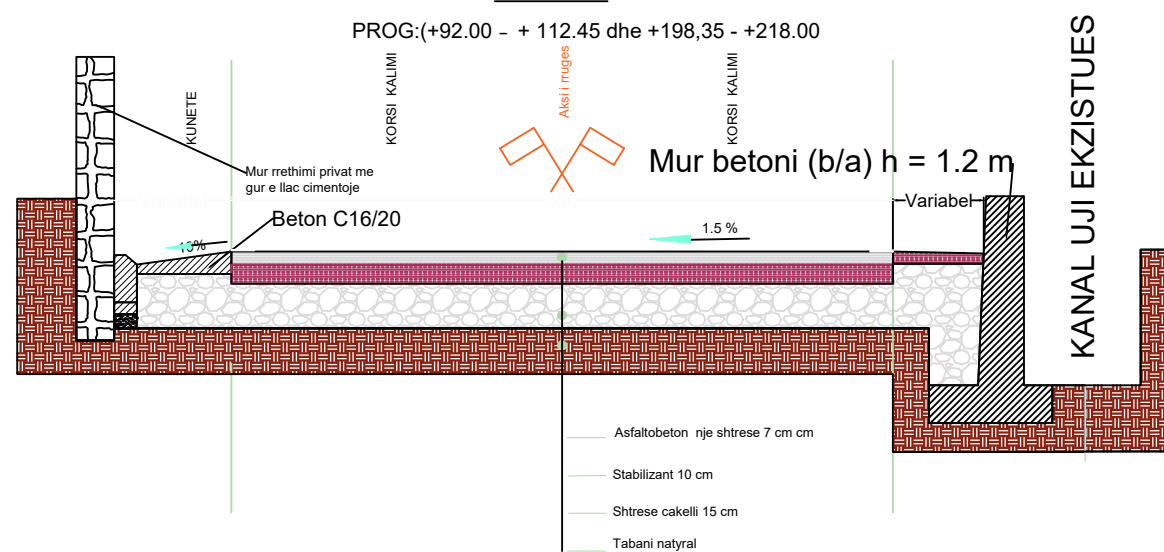

PROFILI TERTHOR TIP 2'  
SH 1 : 40

PROG:(+218,75 - + 238,75 )

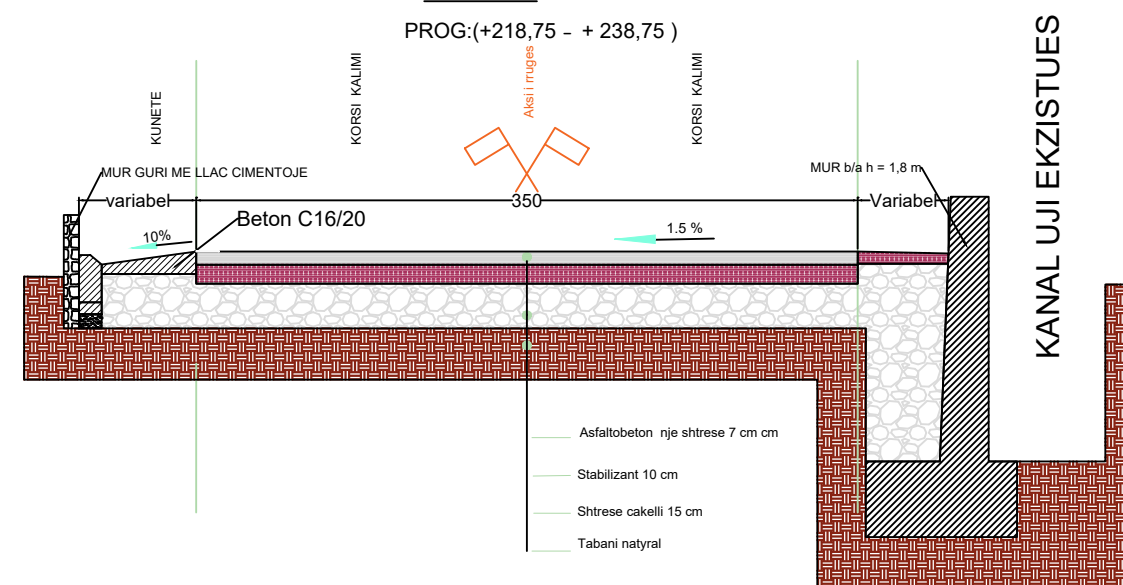

Kastriot Begaj  
Digitally signed by  
Kastriot Begaj  
Date: 2023.10.10  
08:30:33 +02'00'

" PROFILET TIP 1,1',2,2' "	
PROJEKTOI:	ING. KASTRIOT BEGAJ NR LIC. K. 0546/4
PERPUNOI:	ARK. GERTI BEGAJ
PRANOI:	BASHKIA PRENJAS
INVESTITOR:	BASHKIA PRENJAS

Cel : 0682016010, 0692118661, 0695400070



## PRERJE TERTHORE E KUNETES DHE TUBACIONIT S H 1 : 20

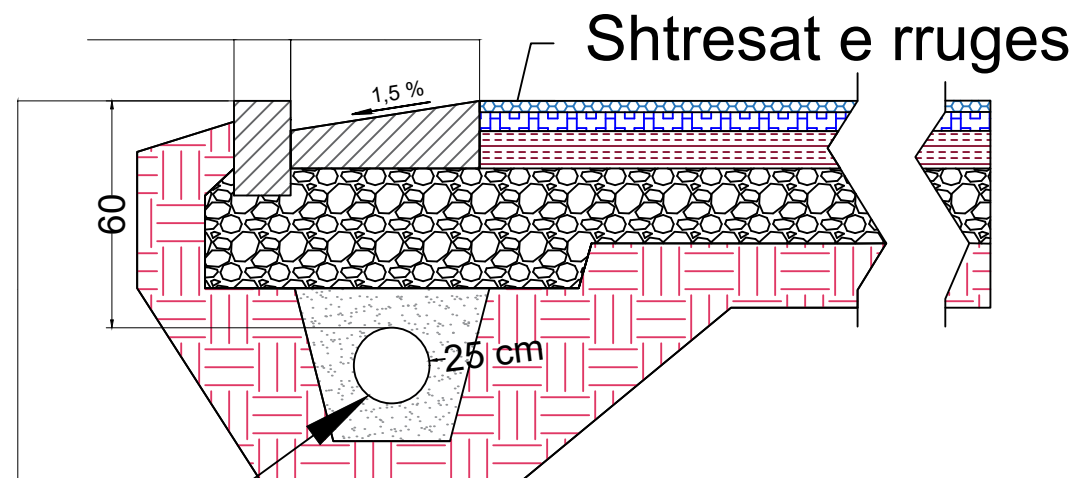

Rubacion HDPE SN8 Ø 250 mm

## FORMA DHE PERMASAT E KUNETES NE VEND KALIMET AUTO (J0 NE SHKALLE, MATJET NE cm)

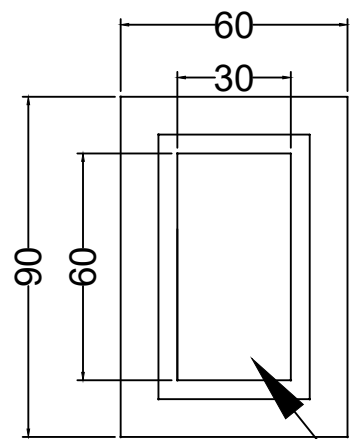
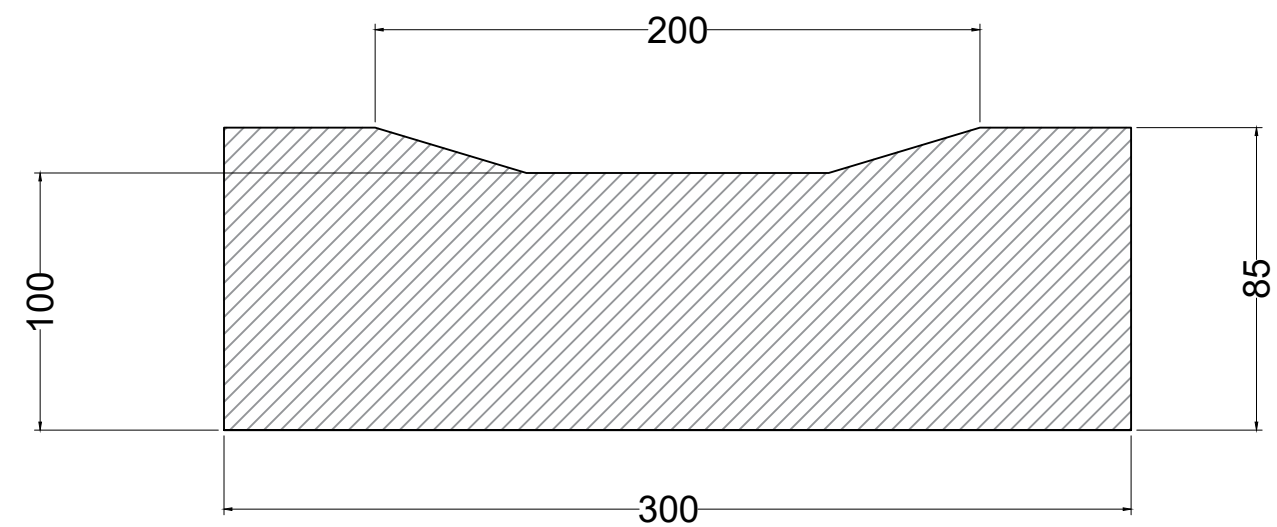

kapak 40x60 cm me vrima

Volumi i betonit per pusete = 0,38 m<sup>3</sup>/cope  
Volumi i betonit per 9 cope = 3,42 m<sup>3</sup>

"SQARIME TEKNIKE "	
PROJEKTOI:	ING. KASTRIOT BEGAJ NR LIC. K. 0546/4
PERPUNOI:	ARK. GERTI BEGAJ
PRANOI:	BASHKIA PRENJAS
INVESTITOR:	BASHKIA PRENJAS
Cel : 0682016010, 0692118661, 0695400070	