

H U K Consulting Engineers

- 20 -

PROJEKT-ZBATIMI

OBJEKTI : TRANSFORMIMI I STACIONEVE TE POMPAVE PEQIN

POROSITES : UJESJELLES KANALIZIME PEQINI sh.a.

Adresa:

Bulevardi ZOGU I
P.58 H2 Ap.9
Tel: 4 2420 288



e-mail:
hukprojekt@yahoo.com

LISTA EFLETEVE TE VIZATIMEVE

PUNIME NDERTIM-HIDRAULIKE

FLETA NR :	EMERTIMI I FLETES VIZATIMIT	SHENIME
1	SKEMA EGZISTUSE E LIDHJES SE PUSEVE	
2	SKEMA E RE E LIDHJES SE PUSEVE	
3	RIKONSTRUKSIONI I STACIONEVE TE UJESJELLESIT PEQIN	
4	REHABILITIMI I STACIONEVE TE POMPAVE PEQIN	
5	VILJA PIEZOMETRIKE	
6	FLETA TEKNOLOGJIKE PER NJE STACION TE RI	
7	FLETANDERTIMORE E NJE STACIONI	
8	DETAJI I LIDHJES SE PUSEVE ME LINJEN KRYESORE PEQIN DQ25	
9	DETAJI I RRETHIMIT PUSIT	
10	PUSETE KANALIZIMI 1m x1m	
11	PUSETE KANALIZIMI 1m x2m	

PUNIME ELEKTRO-MEKANIKE

FLETA NR :	EMERTIMI I FLETES VIZATIMIT	SHENIME
12	KAPAKU	
13	TABELA E SIMBOLEVE (IEC 617 E CEI 3-14...3-26)	
14	PLAN VENDOSJA E STACIONIT DHE DEPOS GRUMBULLIMIT	
15	BLOK SKEMA E EKZISTUESE ELEKTRIKE DHE HIDRAULIKE	
16	HOLLESI E HYRJES KABLORE 6/10 kV NE GODINEN EKZISTUESE	
17	SKEMA E FURNIZIMIT 6/10kV DHE 0.4kV E STACIONEVE TE POMPAVE	
18	KUADROT E TM 6/20kV DHE TE TU 400V	
19	INSTALIMI EL/POMPES ZHYTESE Q=15 L/Sek H=107M	
20	SISTEMI KLORINIMIT	
21	SKEMA E FUNSIONIMIT TE SISTEMIT KLORINIMIT	
22	SKEMA E KOMANDIMI SIPAS NIVELEVE DHE MATJES H,Q dhe kWh	
23	SKEMA ELEKTRIKE E MBAJTJES KONSTANT TE NIVELIT	
34		

INVESTITORI: Ujesjellesi PEQIN

REBILIND	DATA	NGA
HUK Consulting Engineers		PROJEKTI NO: Shkalla 1:5000
Address: Bukurest 200011 P.08152.64.9 Tel. + 3420 288	TITULLI I PROJEKTI: TRANSFORMIMI I STACIONEVE TE POMPAVE PEQIN	DATA Tekst: 2015
e-mail: help@huk.com	Titulli i Vizatimit: LISTA E FLETESVE TE VIZATIMEVE	Projekti: K.Shkalla
	Faza: Projekti rishikim	Konfirmimi: Fleta 1



GJENDJA EGZISTUSE E FUSHES SE PUSEVE - UJESJELLSI I PEQINIT

Sistemi egzistues kerkon 132 KW (4puseX5,5kW +2x55kW St qendror)



RIKONSTRUKSION I STACIONEVE TE UJESJELISIT PEQIN

Te dhënat për linjat e jashtme PEQIN

No	Elementi	PEQIN
1	Q-llëk	56
2	Dc-nm	225
3	D-cm	198.2
4	GLATESIA L-m	2200
5	L ¹ 105	2310
6	V mitek	1.82
7	Humbjelt L-mkm	14.5
8	Kulla e Rezervuarit H m	85
9	Niveli Dinamik në puse	18
10	Heatic m	67
11	Humbjelt Glabazore +2 m	35.485
12	Pumpa HEAD H _p m	102.485
13	avg	47.4
14	H _p +10-avg	112.485
15	Humbjelt H _p +10-Humbjelt	78.905
16	Konkretion H _p sipër presionit maksimal të Erë	76.483
17	Funda e kështjës për H _p	76.483
18	Funda e kështjës për H _p	18.76

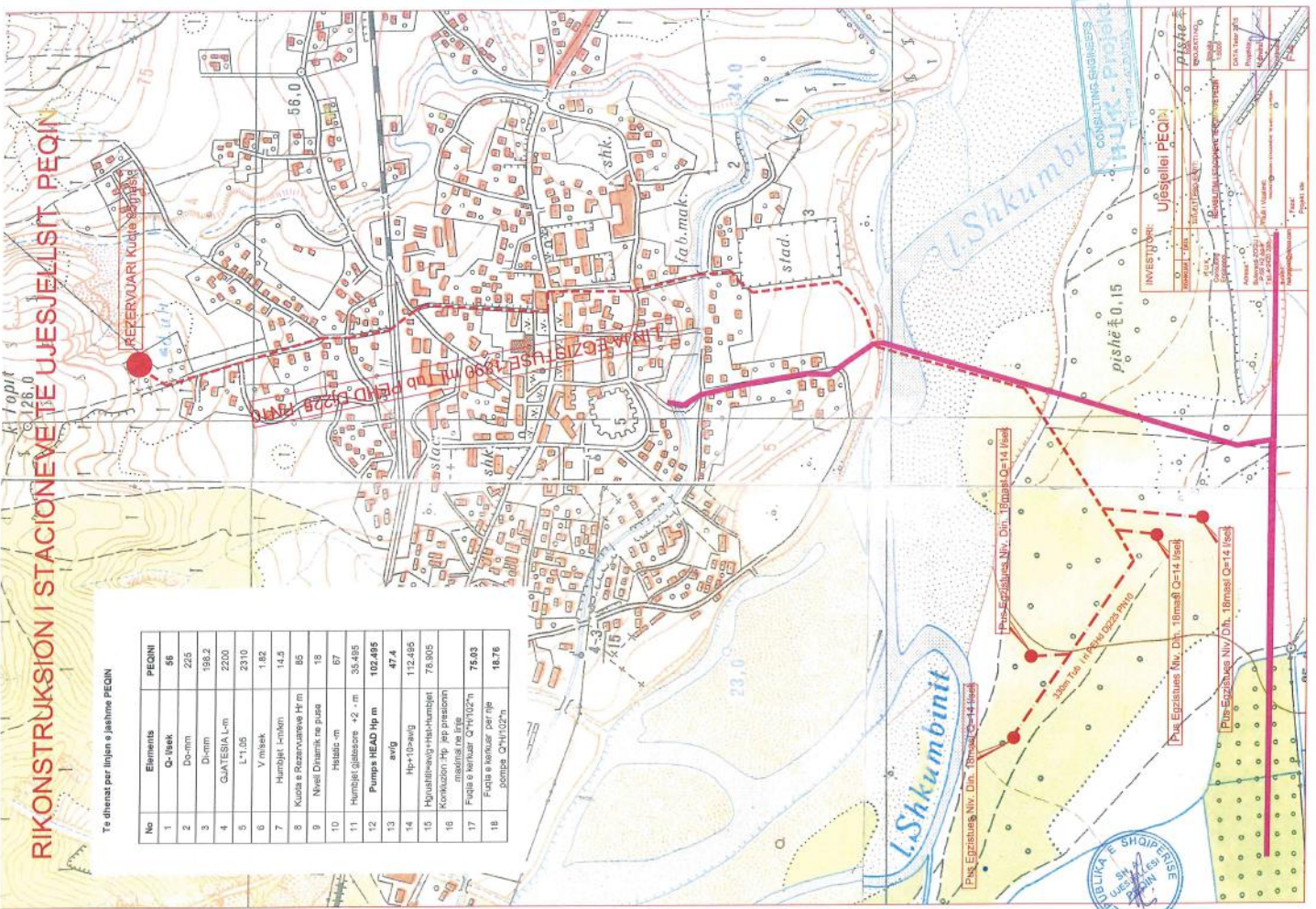

REPUBLIKA E SHQIPËRIE
SH. UJESJELISIT PEQIN

CONSULTING ENGINEERS
inUK - Projekti

DETAJI I LIDHJES SE PUSEVE ME LINJEN KRYESORE PEHD Dj225

TABELA E MATERIALQEVE
Per nryen e bashkimit te puseve me linjen kryesore

No	Emertimi	Copje
1	Tos me gata me dize 45° DN200 PN10	5
2	Copje lule shtepi DN200 L=250mm	4
3	Filanca shtepi DN200 PN10	3
4	Reduktues me filanca DN200x150	3
5	Copje lule me filanca DN150 L=100	15
6	Brigi 45° me filanca DN150	3
7	Filanca adapter per lule PEHD Dj160 PN10	12
8	Filanca funksion DN200 PN10	11
9	Element shtranguas DN150 PN10	5
10	Regjulator presioni DN150 PN10	4
11	Saracineska DN150 PN10	10
12	Tos me filanca DN150x40	10
13	Regjulator presioni per lule shtepi DN150 PN10	10
14	Saracineska DN150 PN10	10

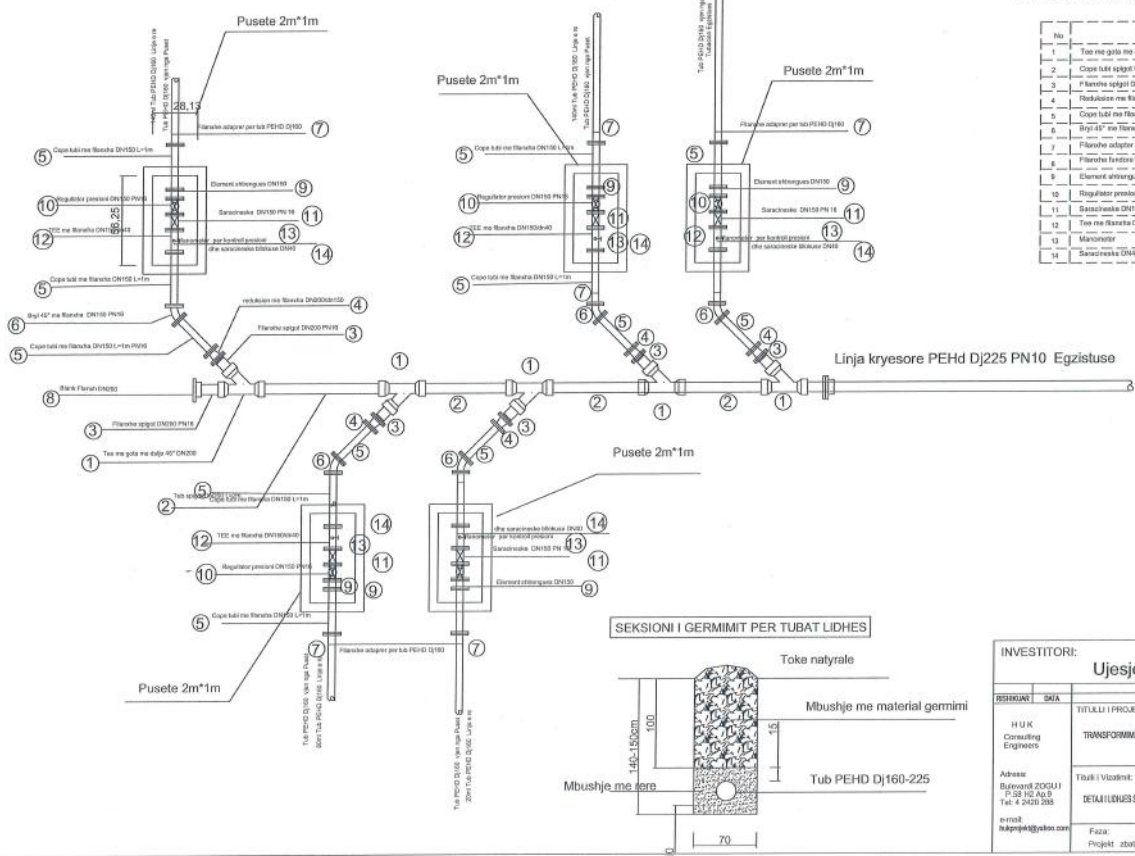

CONSULTING ENGINEERS
HUK - Projekt
TIRANE - ALBANIA

INVESTITORI: **Ujesjellesi PEQIN**

REZHEMI	SHIA	NGA
HUK Consulting Engineers	TITULLI I PROJEKTTIT: TRANSFORMIMI I STACIONEVE TE POMPAVE PEQIN	PROJEKTI NO.:
Adress: Bulevardi ZOGU I P. 58 100 TIRANE Tel: 4 2420 283	TUHU I VESHTRES: DETAJI I LIDHJES SE PUSEVE ME LINJEN KRYESORE PEHD Dj225	DATA Tetor 2015
e-mail: hukproj@yaho.com	Faza: Projekt shpreh	Projekti: K.Stehi
		Kontrolli: K.Stehi

PAMJE E RRETHIMIT

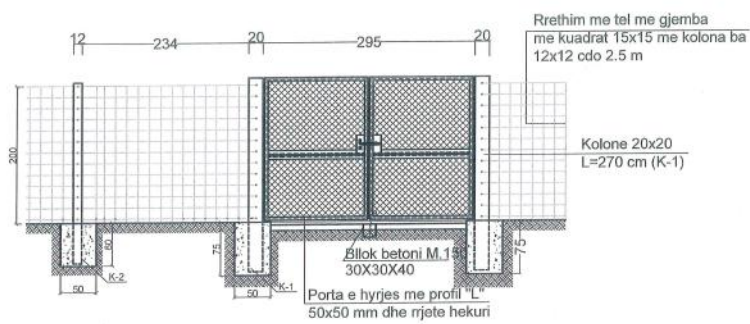

PLANI I RRETHIMIT

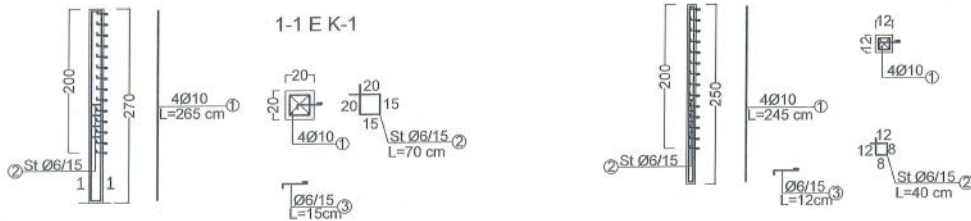
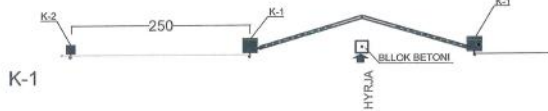

VOLUMET E PUNES PER 2.5 m RRETHIM			
Nr.	Pershkrimi	Njesia	Sasia
1	Germim dheu per plinta	m3	0.13
2	Beton M.100 per themele	m3	0.1
3	Kollona ba	m3	0.036
4	Hekur betoni	kg	5.9
5	Rrjete teli	m2	5

VOLUMET E PUNES PER PORTEN			
Nr.	Pershkrimi	Njesia	Sasia
1	Germim dheu per plinta	m3	0.68
2	Beton M.100 per themele	m3	0.058
3	Kollona ba	m3	0.22
4	Hekur betoni	kg	20
5	Rrjete teli	m2	6
6	Konstruksion metalik	kg	72



INVESTITORI:		
Ujesjellesi PEQIN		
ORGANIZIMI	ADRESA	NR. DATA
HUK Consulting Engineers	Blloku 8, 20001 P.O. Box 15, 2003 Tel: 4 24 02 288	01/2017
TITULLI I PROJEKTE	TRASHKIM I STACIONES TE POMPAVE PEQIN	PROJEKTI NO:
TIMI I VEPRIME	Detaji i Rrethimit te Puseve	Skema 1/0
Faza	Projektimi	DATA Tabor 2017
		Propozim
		K.Shahu
		Kontrakt
		Fleta 09

PAMJE NGA LART

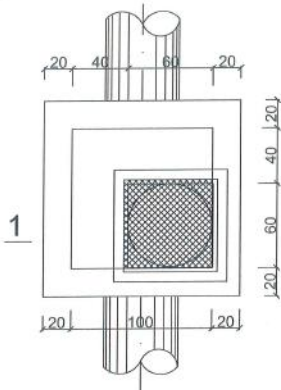

PLANIMETRIA

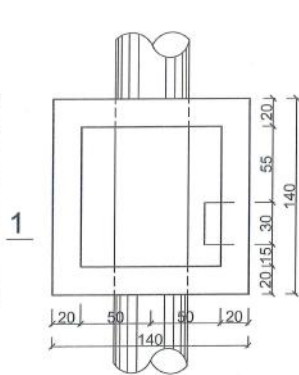

PLANIMETRIA

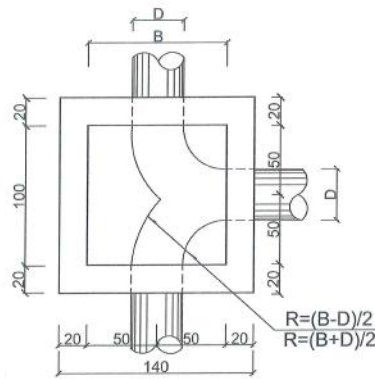

ARMIMI I SOLETES

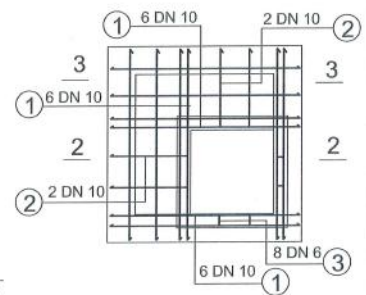

DETAJI I SHKALLES

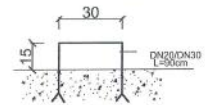

1-1



TABELA E HEKURAVE

NR	SKEMA	DN	L (cm)	COPE	L (m)	DN	L (m)	Kg
1	137	10	152	12	18,3	10	28,4	17,6
2	57 22 13	10	104	4	4,2	6	9,4	3,7
3	22 17	10	78	12	9,4			
4	82 77	10	318	1	3,2			
5	68 63	10	262	1	2,62			
Gjithsej 21.3 kg								



INVESTITORI:		
Ujesjellesi PEQIN		
SHKURIM	DATA	NGA
HUK Consulting Engineers		PROJEKTI NO.:
TITULLI I PROJEKTI:		SHKILLA
TRANSFORMIMI I STACIONEVE TE POMPAVE PEQIN		DATA Tëror 2015
Tërbësi i Vazhduar:		Projektori:
PUSËTE KANALIZIMI 1m x 1m		K.Shaha
Paza:		Kontrollori:
Projekt zbatim		Fleta 10

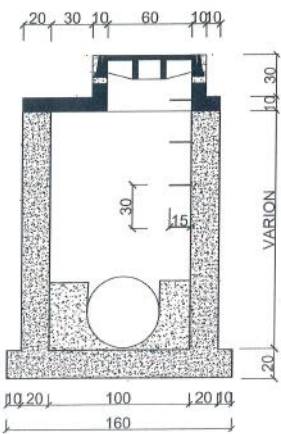
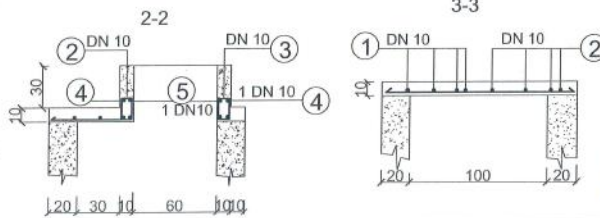

PLANI I PUSETES SHK.1:50

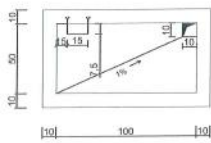

MBULIMI I PUSETES SHK.1:50

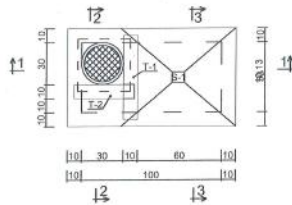

PRERJA 1-1 SHK.1:50

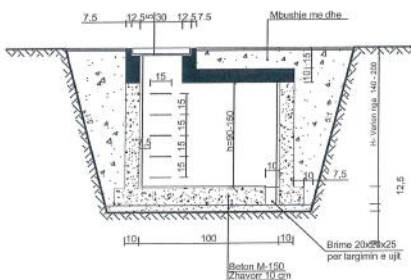

SOLETA S-1 SIPAS 1-1

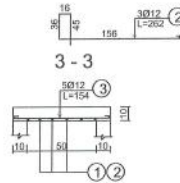
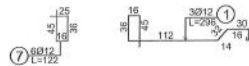
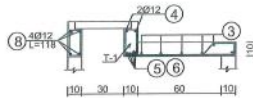

TRAU T-1 SHK.1:25

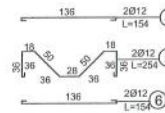
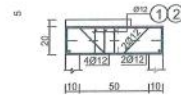

TRAU T-2 SHK. 1:25



TABELA E HEKURAVE

ELEMENTI	LLOJI	COPE	SPECIFIKIMI		ARMATURA E PERGJ		PESHA	PESHA	TOTALE kg
			Nr	Ø	L	cm			
MBULIMI I PUSETES	1	1	12	296	3	0.98	12	73.14	64.94
		2	12	262	3	7.96			
		3	12	154	5	0.90			
		4	12	154	2	3.08			
		5	12	254	2	5.08			
		6	12	156	2	3.08			
		7	12	122	12	14.64			
		8	12	118	8	9.44			
		9	12	166	2	3.72			
		10	12	114	4	4.56			
		11	12	162	3	4.86			
		12	12	114	1	1.14			
SHKALLA	13	20	730	6	7.80	20	7.80	19.20	19.20

Betoni M-150 kg/cm²
Heker C-3
SHUMJA kg = 94.14

TABELA E VOLUMEVE TE PUNES

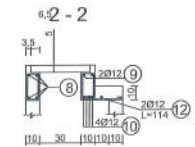
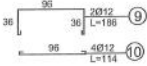
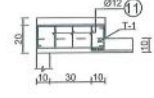
Nr	PERSHKRIMI I PUNIMEVE	Njesia	SPECIFIKIMI			
			H=140	H=150	H=170	H=200
1	GERMMI DHEU	m ³	12.85	13.98	15.63	18.85
2	MUSHAJE	m ³	7.00	7.12	8.97	10.23
3	MURE BETONI M-150	m ³	1.22	1.36	1.63	2.04
4	SOLETA B/A M-150	m ³	0.54	0.54	0.54	0.54
5	TRARE B/A M-150	m ³	0.14	0.14	0.14	0.14
6	SHTRESE BETONI M-150	m ³	1.14	1.16	1.10	1.16
7	SHTRESE ZHAVORRI 10 cm	m ³	0.55	0.55	0.55	0.55
8	SUVATIM ME LLAC/B M-30	m ²	6.38	6.98	8.18	9.96
9	SHTRESE LLAC CIMENTO 1:2	m ²	2	2	2	2
10	HEKUR BETONI	kg	84.14	84.14	84.14	84.14
11	KAPAK PUSETE Ø-80	copa	1	1	1	1

INVESTITORI:

Ujesjellesi PEQIN

RESHIRJE	DATA	TITULLI I PROJEKTI:	NSA
HUK Consulting Engineers		TRANSFORMIM I STACIONEVE TE POMPIVE PEQIN	SHKALLA
Adresa: Rruges 2000/1 P.O. Box 9 Tirane, Albania Tel: +355 22 288 huk@huk-engineers.com		Titulli i Vizimit: PUSETE UJESJELLES 1 m X 2 m	DATA Tatar 2016 Projektuar K.Shirazi Kontroluar: Flota
		Faza: Projekt shkur	11



PROJEKTI ELEKTRIK



INVESTITORI:		Ujesjellesi PEQIN	
NR. SHKRUARJE	DATA	TITULLI I PROJEKTE	SKALA
H.U.K. Consulting Engineers		TRANSFORMER I STACIONEVE TE POMPAVE PEQIN	Shkalla 1:5000
Adresa	Tirazi / Vendi	LISTA E FLETEVE TE VIZATIMEVE	DATA Tekor 2015 Projektori P.Faqih
Bulevardi ZOGU I P.O. Box 1493 Tel: +355 202 388			Kontaktesha K. Shaha
e-mail: hukprojekti@peqin.com	Faqe		Fleta 12
	Projekti	Shahin	

TABELA E SIMBOLEVE (NORMA IEC 617 E CEI 3-14...3-26)

SIMBOLI	CODI IEC	EMERTIMI	SIMBOLI	CODI IEC	EMERTIMI	SIMBOLI	CODI IEC	EMERTIMI
		Sigurcese			Buton normalisht i mbyllur qe hapet me rrotullim			Antena katelitore
		Thike teke			Llampe shfaqjeje			Antena radio
		Role terminal			Prize			Ndricues ne mur
		Ampometror			Prize 5 pinore			Llampe inkandeshence
		Voltmetror			Cofes ndricimi			Prezhektor
		Mafex energjie			Ndricues			Ndricues me 3 neone
		Buton normalisht i hapur			Bart			Tabole shfaqjeje
		Buton normalisht i mbyllur			Kuadror elektrik			Zile
		Buton normalisht i hapur qe mbyllet me rrotullim			Bobine kontaktori			Kondensator

SIMBOLI	CODI IEC	EMERTIMI	SIMBOLI	CODI IEC	EMERTIMI	SIMBOLI	CODI IEC	EMERTIMI
		Pushbujelle me rrotullim			Rashkrim percilleshesh			Cofes Thike
		Pushbujelle yll			Mersctori			Tekezin
		Pushbujelle yll me pjete mesit			Kontakt normalisht i mbyllur			Linje ajrore
		Rrejt 3fazore			Bllok kontakt normalisht i mbyllur hapur			Linje kablore
		Percilles 3 fazor			Kontakt i normalisht i hapur qe mbyllet me vonese			Kabinat elektrike
		Drejtes rryme			Kontakt i normalisht i hapur qe mbyllet menjehere			Shuarkecs
		Diode			Kontakt normalisht i mbyllur qe hapet me vonese kabe			Transformator fuqje
		Ndryshues tensioni (SS)			Kontakt qe mbyllet manualisht			Transformator rryme
		Ndryshues frekuence (VSD)			Kontakt normalisht i mbyllur			Rrejt 3fazor



INVESTITORI: Ujesjellesi PEQIN

RESHTIMET	DATA	NR. I PROJEKTTIT	NR. I PROJEKTTI NG.
HUK Consulting Engineers		TRANSFORMIMI I STACIONEVE TE POMPAVE PEDIN	Shkalla 1:5000
Adresat: Bulevardi 2000 I P.38 Nr.4p.3 Tel: 4 2506 288		TITULLI I VIZITIMIT: LISTA E FLETEVE TE VIZATIMEVE	DATA Tetor 2015
e-mail: hukupjekt@peqin.com		Fazet: Projekt shpirtim	Projektimi P. Peqini
			Kontrollimi R. Shehu
			Fleta 13

**BLOK SKEMA E EKZISTUESE ELEKTRIKE DHE
HIDRAULIKE E UJESJELLESIT PEQIN**

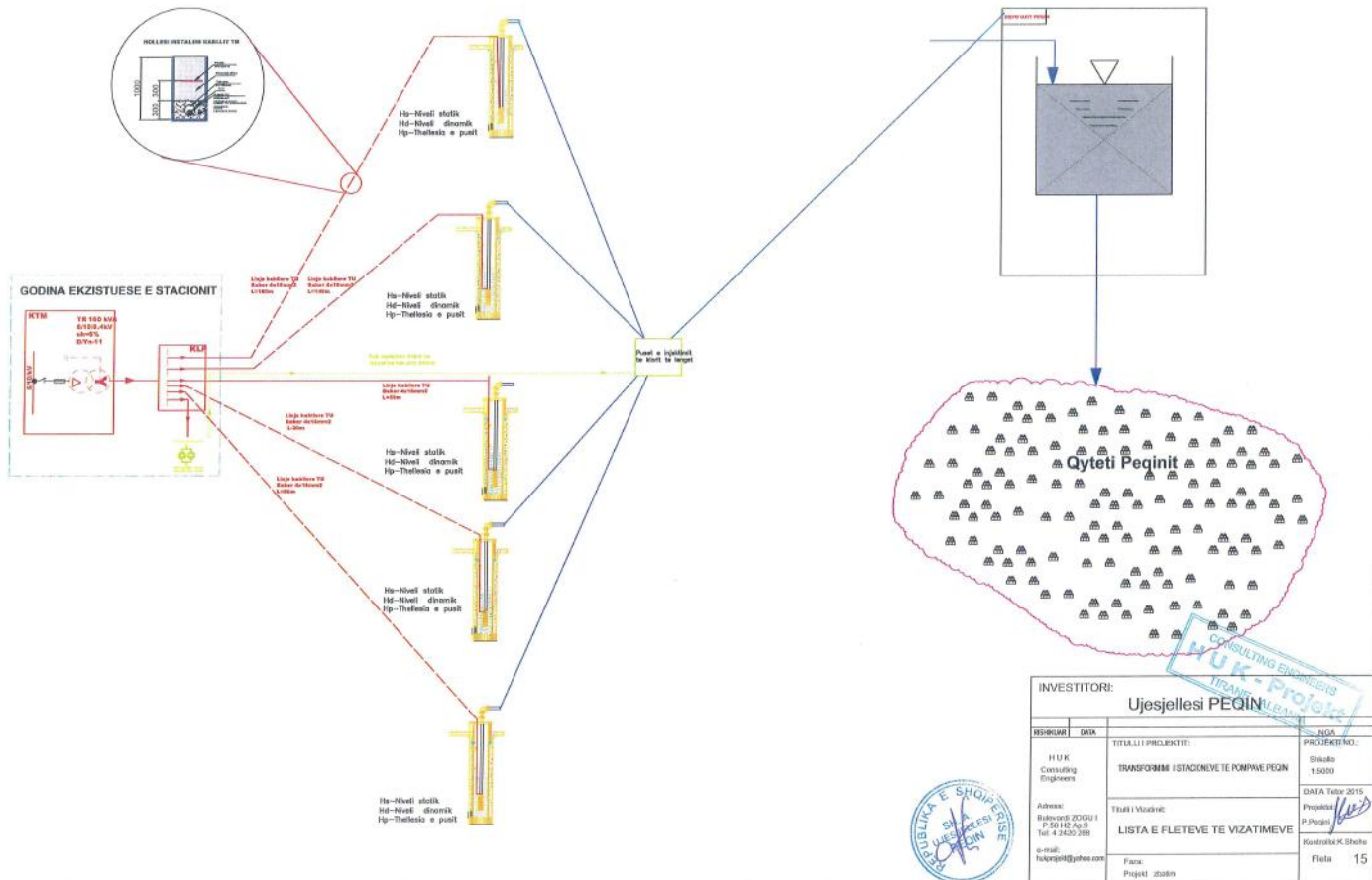

**HOLLESI E HYRJES KABLORE 6/10 KV NE GODINEN EKZISTUESE
TE STACIONIT TE POMPAVE**

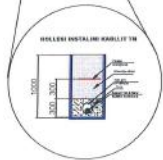
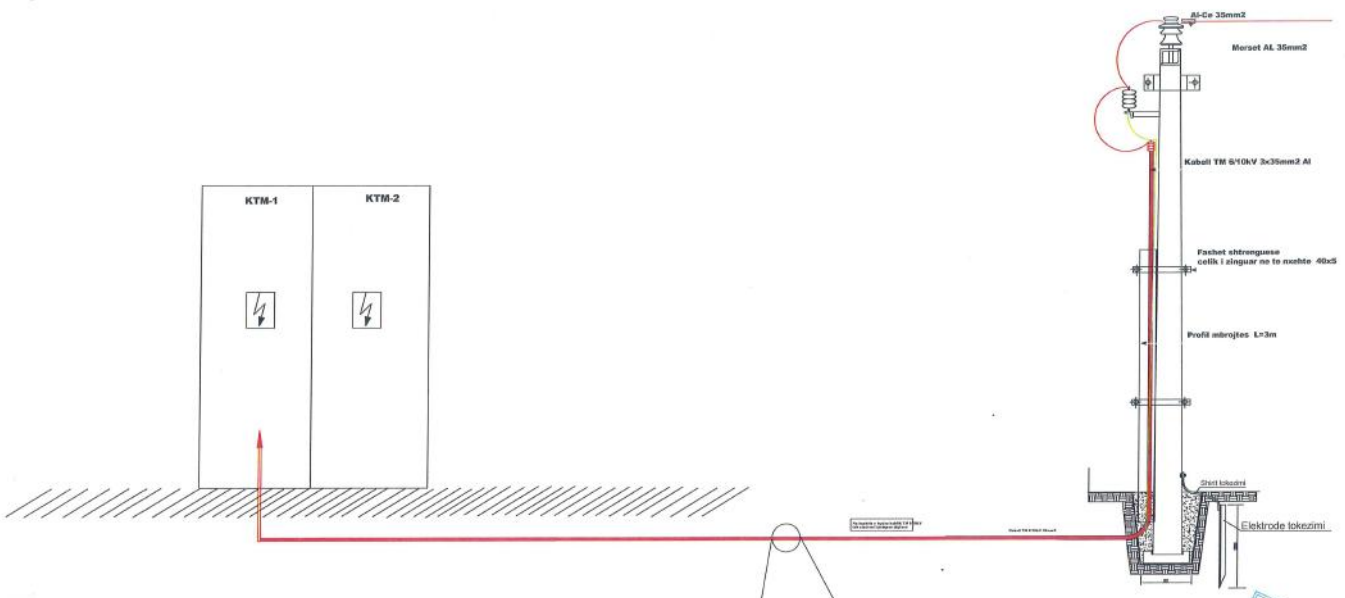

CONSULTING ENGINEERS
HUK-Projekt
DIPLOM - ALBANIA

INVESTITORI: **Ujesjellesi PEQIN**

NR/SHUMI	DATA	TITULLI I PROJEKUT	SKALA
HUK Consulting Engineers		TRANSFORMIMI I STACIONEVE TE POMPAVE PEQIN	Skala 1:5000
Adresa: Bulevardi ZOGU I P.50 112, TIRANE Tel: 4 2420 288		TIRANE / Vendet LISTA E FLETEVE TE VIZATIMEVE	DATA Tetor 2015 Projektori P.Peqini Korrihan, K.Shahu
e-mail: hukprojekt@huko.com		Fleta Projekti shifrimi	Fleta 16



KUADROT E TM 6/20kV DHE TE TU 400V

PAMJA E KUADROVE TM 6/10kV

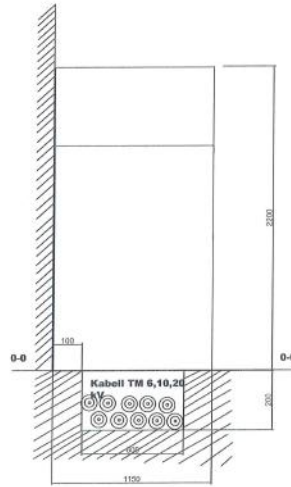
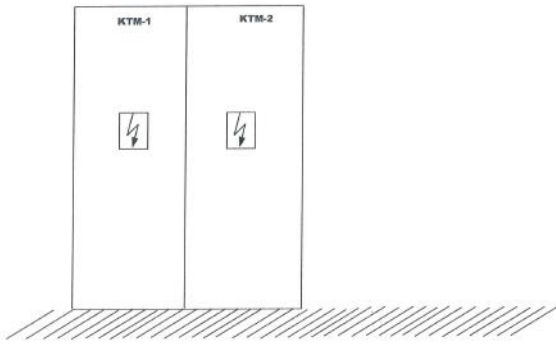

PAMJA E KUADROVE TU 400V

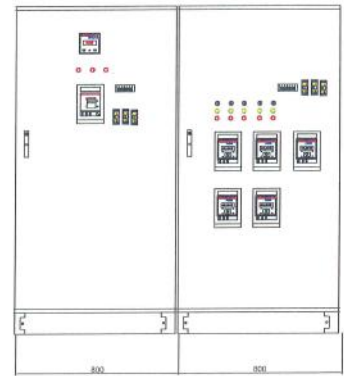

INVESTITORI: Ujesjellesi PEQIN

SHIFRA	DATA	TITULLI I PROJEKTE	NOA
H U P K Consulting Engineers		TRANSFORMER / STACIONEVE TE POMPAVE PEQIN	PROJEKTI NO. 1 Shikë 1.5000
Adresa: Buzkovaç ZOGU I P.8841, Peqi Tel: +355 288		Titull i Muarve: LISTA E FLETEVE TE VIZATIMEVE	DATA Tërviz. 15.11.15 Projektori: P. Peqini Kontrolluar: K. Sheta
e-mail: hupk@hupk.com		Faza: Projekti shikë	Fleta 18



INSTALIMI I ELEKTROPOMPES ZHYTESE Q=14L/sek H=108m

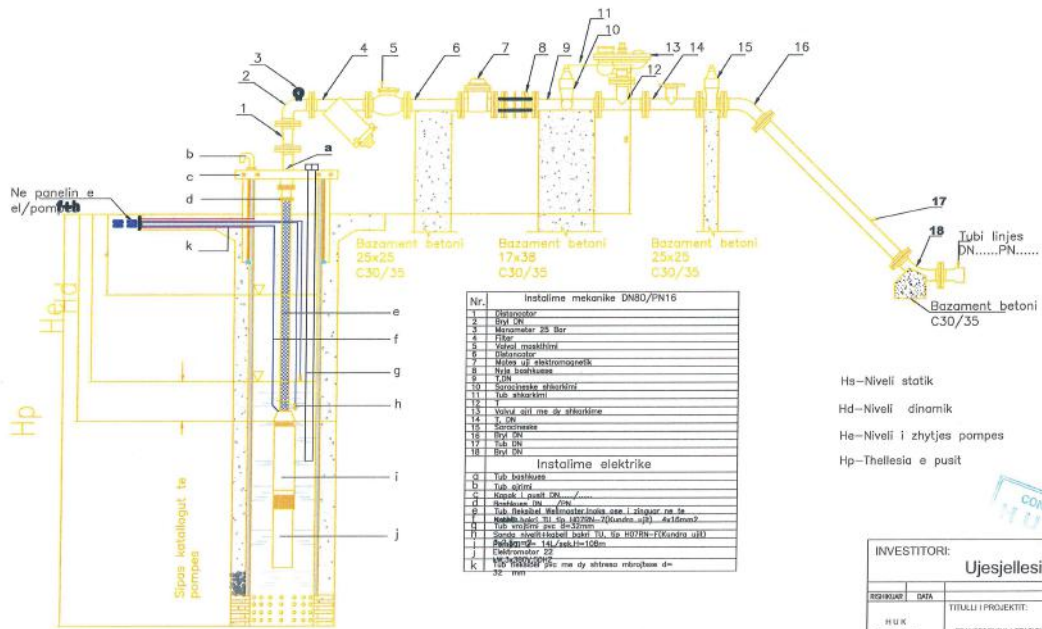

Nr.	Instalime mekanike DN80/PN16
1	Detegjues
2	Valv
3	Marrmshetar 25 Bar
4	Filoz
5	Valvot nyqkthimi
6	Distancator
7	Niveli ul elektromagnetik
8	Valv nyqkthimi
9	Valv nyqkthimi
10	Shtesues elektrikez
11	Valv nyqkthimi
12	Valv
13	Valv ul me sh. shkarkime
14	Valv
15	Shtesues
16	Valv
17	Valv DN
18	Det. det.
Nr.	Instalime elektrike
Q	Tubi bashkues
R	Tubi ajrimit
S	Kabllo i shtetit DN
T	Bashkues. det.
U	Kabllo i bashkuar me sh. shkarkime
V	Kabllo i bashkuar me sh. shkarkime
W	Kabllo i bashkuar me sh. shkarkime
X	Kabllo i bashkuar me sh. shkarkime
Y	Kabllo i bashkuar me sh. shkarkime
Z	Kabllo i bashkuar me sh. shkarkime
AA	Kabllo i bashkuar me sh. shkarkime
AB	Kabllo i bashkuar me sh. shkarkime
AC	Kabllo i bashkuar me sh. shkarkime
AD	Kabllo i bashkuar me sh. shkarkime
AE	Kabllo i bashkuar me sh. shkarkime
AF	Kabllo i bashkuar me sh. shkarkime
AG	Kabllo i bashkuar me sh. shkarkime
AH	Kabllo i bashkuar me sh. shkarkime
AI	Kabllo i bashkuar me sh. shkarkime
AJ	Kabllo i bashkuar me sh. shkarkime
AK	Kabllo i bashkuar me sh. shkarkime

- Hs--Niveli statik (m)
- Hd--Niveli dinamik (m)
- He--Niveli i zhytjes pompes (m)
- Hp--Thellessia e pusit (m)



INVESTITORI:		Ujesjellesi PEQIN	
SHIKIMI	DATA	TITULLI I PROJEKTI:	SKALA
HUK		TRANSFORMIMI I STACIONEVE TE POMPEVE PEQIN	Shkalla 1:5000
Adresa:		Titulli i Vizimit:	DATA Teter 2015
Dukovana 202011		LISTA E FLETETEVE TE VIZATIMEVE	Projektori: P.Peqini
P.O. Box 100			Kontrolluesi: K.Shyti
Tel: +355 2420 208			Fleta 19
e-mail: hukpeqin@peqin.com		Faza: Projekt. caktim	

SISTEMI KLORINIMIT

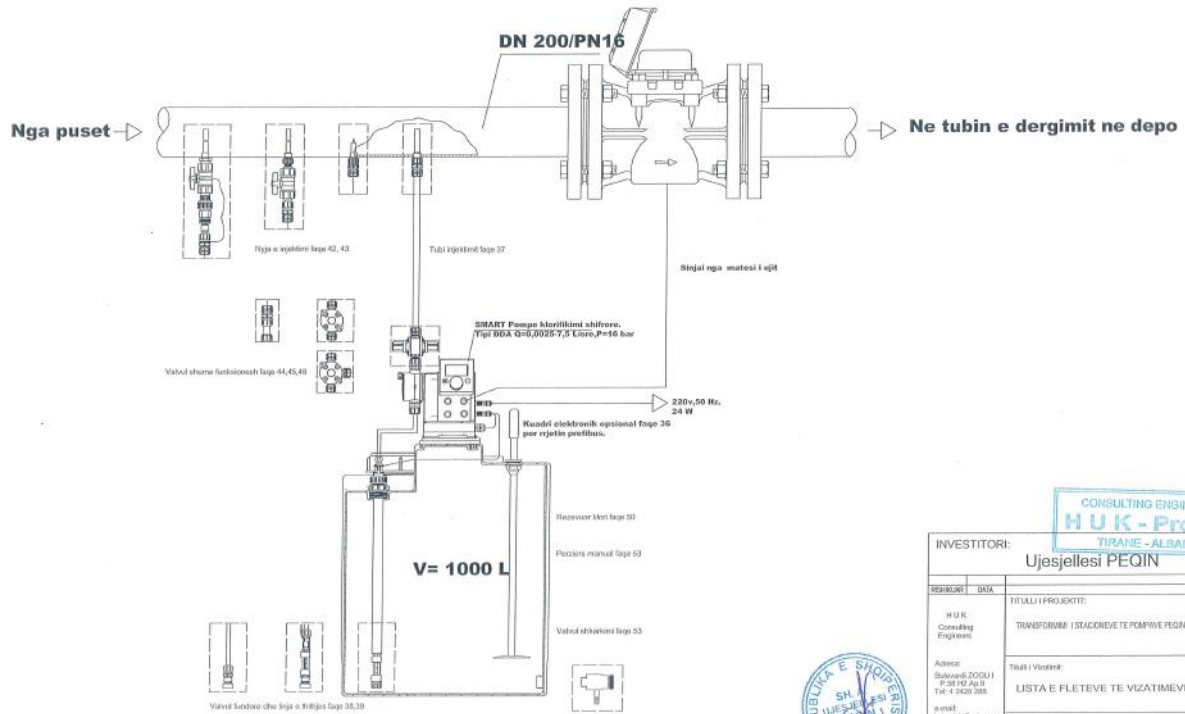

CONSULTING ENGINEERS
H U K - Projekt
TIRANE - ALBANIA

INVESTITORI:		Ujesjellesi PEQIN
ORGANIZIMI	EMRI	SIGLA
H U K Consulting Engineers	TITULLI I PROJEKTTI: TRANSFORMIMI I STACIONIT TE POMPIVE PEQIN	PROJEKTI NO. Shkalle 1:5000
Adresa: Bulevardi ZOGU I P.28142 Ap.9 Tirë 4 2020 285	Titulli i Vizatimit: LISTA E FLETËVE TE VIZATIMEVE	DATA Tëty 2015
e-mail: hukproj@hukoo.com	Faza: Pregjat shfitem	Projektuar: P. J. Peqini Kontrolluar: E. Shkalla Fleta 20



SKEMA E FUNSIONIMIT TE SISTEMIT KLORINIMIT

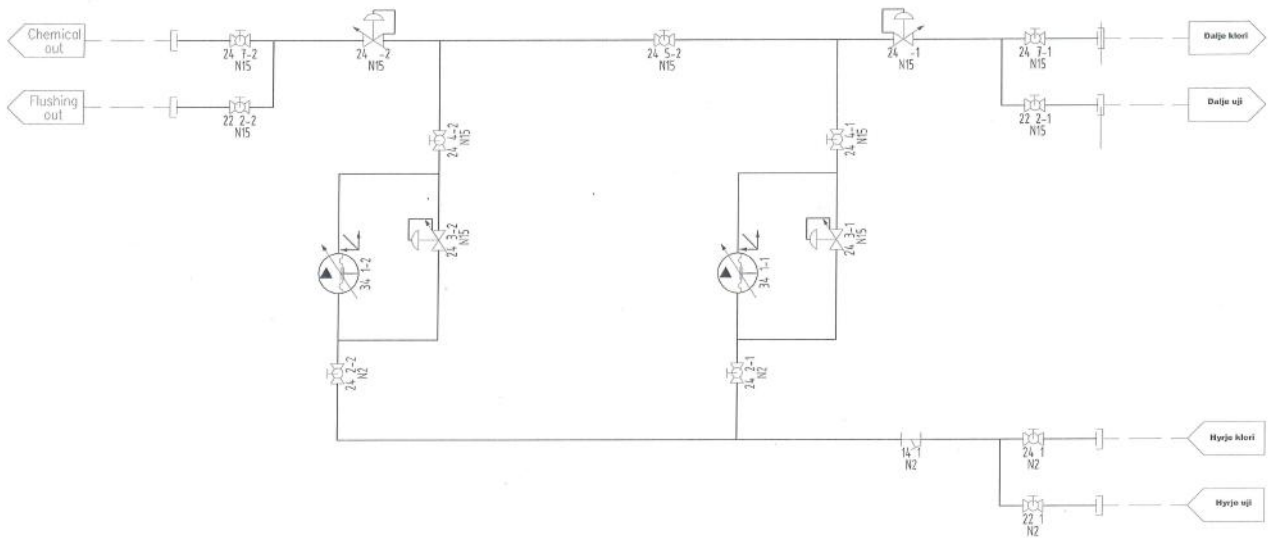

INVESTITORI: Ujesjellesi PEQIN

CONSULTING ENGINEERS
HUK-Projekt

REZHIMI	DATA	TITULLI I PROJEKTTË	SKALA
HUK Consulting Engineers		TRANSFORMIMI I STACIONEVË TE POMPAVE PEQIN	Skala 1:5000
Adresa: Bulevardi ZOGUJ I P. 5910 T.G. P. Tel: 4 2420 338		Tirazi i Nivellit: LISTA E FLETËVE TE VIZATIMEVE	DATA TIRAZI 2015
e-mail: hukprojekt@yahoo.com		Faza: Projekt shkuror	Fletja 21



SKEMA E KOMANDIMIT SIPAS NIVELIT DHE MATJA E PRURJES ,NIVELEVE DHE ENERGJISE ELEKTRIKE

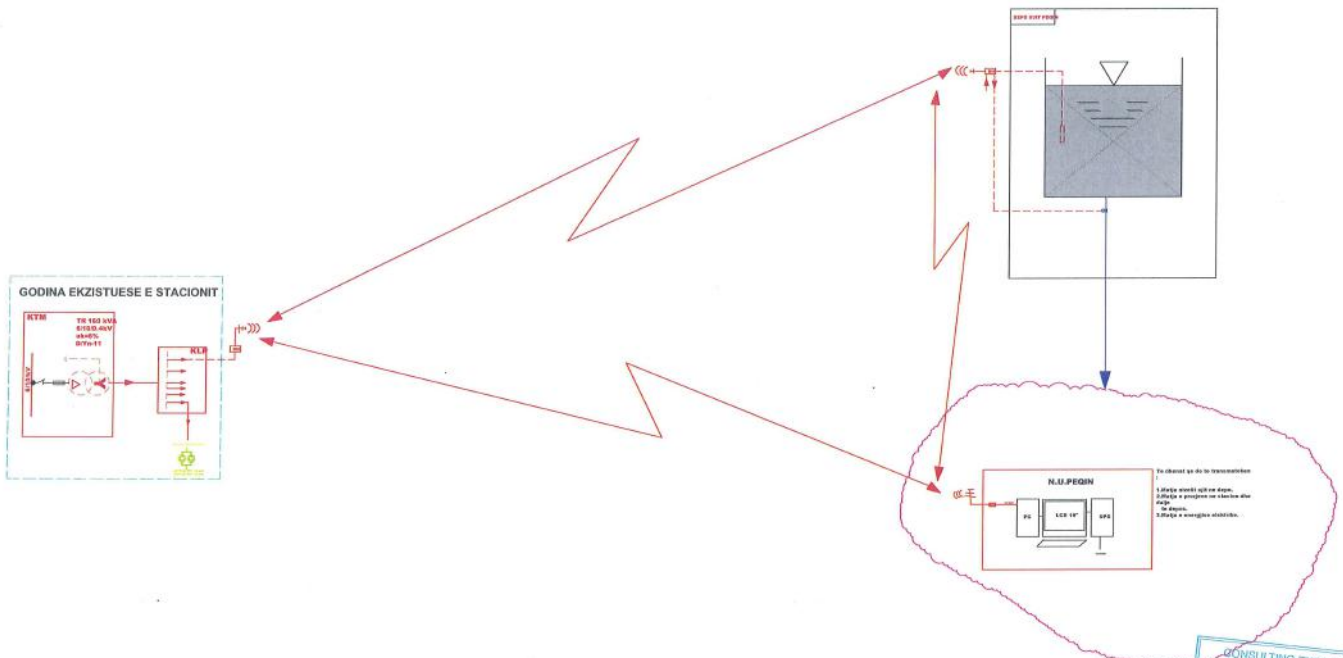

CONSULTING ENGINEERS
HUK - Projekti

INVESTITORI:		Ujesjellesi PEQIN	
REKURAR	DATA	TITULLI I PROJEKTI:	NGA
HUK Consulting Engineers		TRANSFORMER I STACIONEVE TE POMPAVE PEQIN	Shekulli 1:2000
Adresa: Bulevardi 2000/1 P.58112 Ag.3 Tel: 4 2420 388		Titulli i Vizatimit:	PROJEKTI NO.:
e-mail: hukan@huk.com		LISTA E FLETEVE TE VIZATIMEVE	DATA Tetor 2015
Firma: Projekt sh.kom			Projektori: P.Pajziti
			Kontrolluesi: K.Shehu
			Fleta: 22



SKEMA ELEKTRIKE E MBAJTJES KONSTANT TE NIVELIT

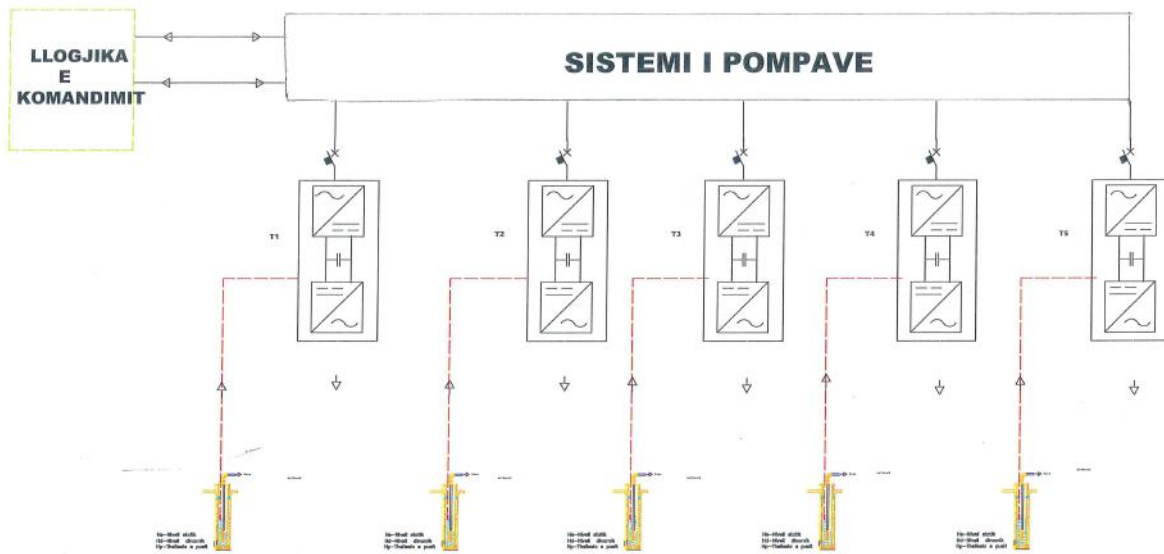

CONSULTING ENGINEERS
HUK - Projeke
 TIRANE - ALBANIA

INVESTITORI: **Ujesjellesi PEQIN**

RESHKIMI	DATA	TITULLI I PROJEKTI:	NGA
HUK Consulting Engineers		TRANSFORMIMI I STACIONEVE TE POMPAVE PEQIN	Shkalla 1:5000
Adresat:		Titulli i Vendeut:	DATA Tetor 2015
Blloqet 200/11 P.O. Box 443 Tirane 4100		LISTA E FLETEVE TE VIZATIMEVE	Projektuesi P. Peqini
e-mail: huk@huk.com		Faza: Projekt shkurter	Kontrakti/Detyra: Kontrakti/Detyra
			Fleta 23

