

PROJEKT ZBATIMI

NDËRTIM RRUGET VALIAS

NDERTIM TROTUARET, ELEKTRIKET DHE KUB E RRUGEVE ("JONE" + "FUSHE ARREZ")



BASHKIA KAMËZ

MIRATOI

KRYETAR I BASHKISË KAMËZ

Z.RAKIP SULI



BASHKIA KAMËZ

DREJTORIA E SHERBIMEVE PUBLIKE
DREJTORIA E PROJEKTEVE DHE INVESTIMEVE
DEPARTAMENTI I PROJEKTEVE

Dr. i Pergj. i Sherbimeve Publike	ELVIS GJIKA		
Dr. e Projekteve e Investimeve	FLORA MUCA		
STAFI TEKNIK PROJEKTUES	Ing. Konstruktore	EMANUELA MËZIU	
	Ing. Gjeoinformatik	ERBLIN LALA	
	Ing. Preventivues	HAJREDIN MURGU	
	Ing. Topograf	RAMADAN HYSA	

Titulli i Projektit NDËRTIM RRUGET "VALIAS",	Faza e Projektit PROJEKT ZBATIMI
Emertimi i Fletes KAPAKU	Data e Implementimit: Shkalla e Vizatimit Fleta Nr. A-00

PLANVENDOSJA L_{TOT} = 1240 ML

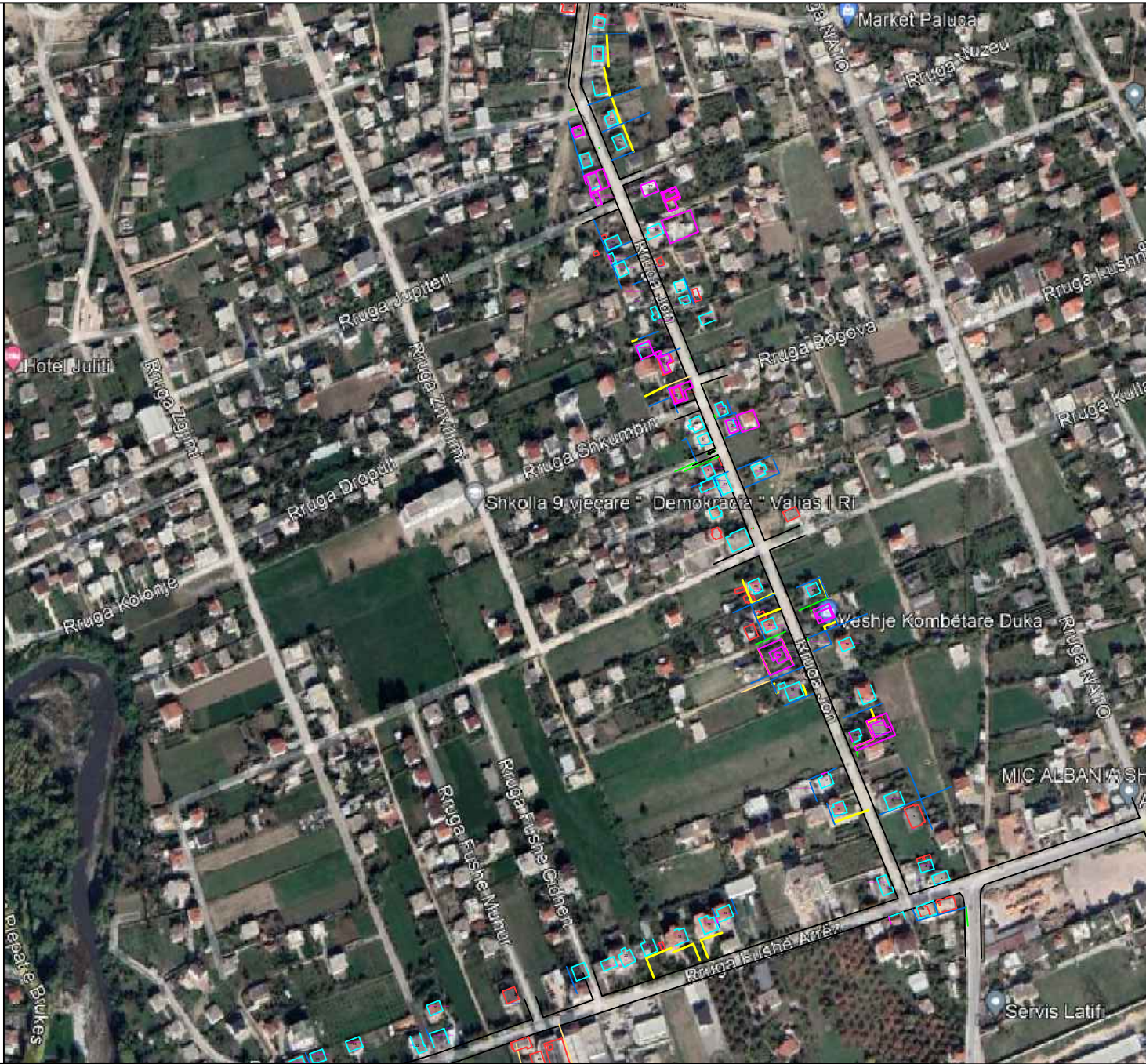

Detajli i Investimit

Pozicionimi ne Investim

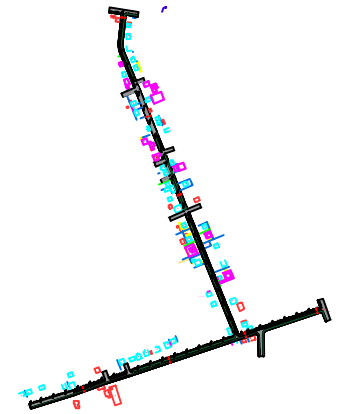

BASHKIA KAMEZ

DREJTORIA E SHERBIMEVE PUBLIKE
DREJTORIA E PROJEKTEVE DHE INVESTIMEVE
DEPARTAMENTI I PROJEKTEVE

Dr. i Pergj. i Sherbimeve Publike	ELVIS GJIKA
Dr. e Projekteve e Investimeve	FLORA MUÇA

STAFI TEKNIK PROJEKTES	Ing. Konstruktor	EMANUELA MEZIU
	Ing. Gjeoinformatik	ERBLIN LALA
	Ing. Preventivues	HAJREDIN MURGU
	Ing. Topograf	RAMADAN HYSA

Titulli i Projektit		FAZA e Projektit
NDERTIMI TROTUAR+NDRICIM+KUB RRUGA "JONE+FUSHE ARREZ" Valias		PROJEKT ZBATIMI
Data e Implementimit :		

Emertimi i Fletes		Shkalla e Vizatimit
PLANVENDOSJE		
Fleta Nr.		A-00

PLANIMETRI TROTUAR+NDRICIM L= 800 ML

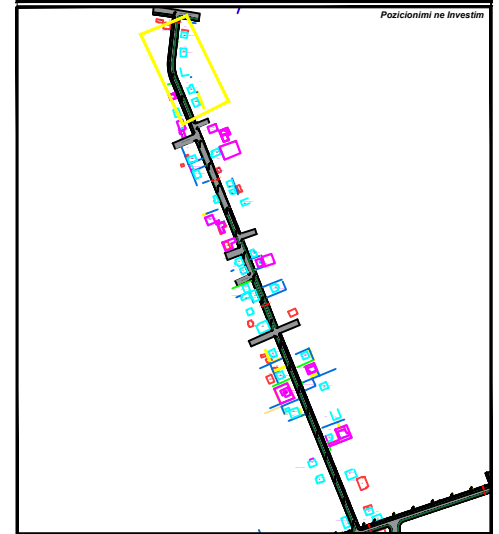
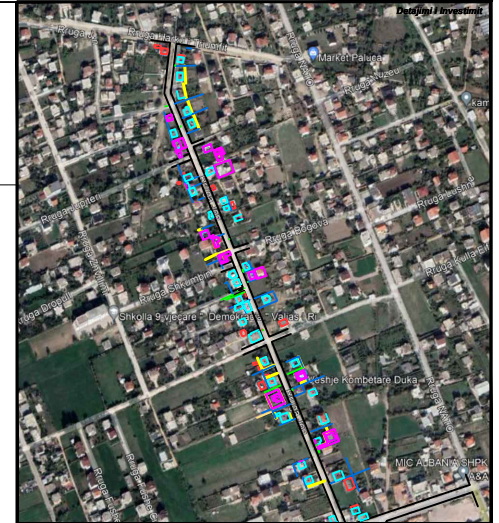
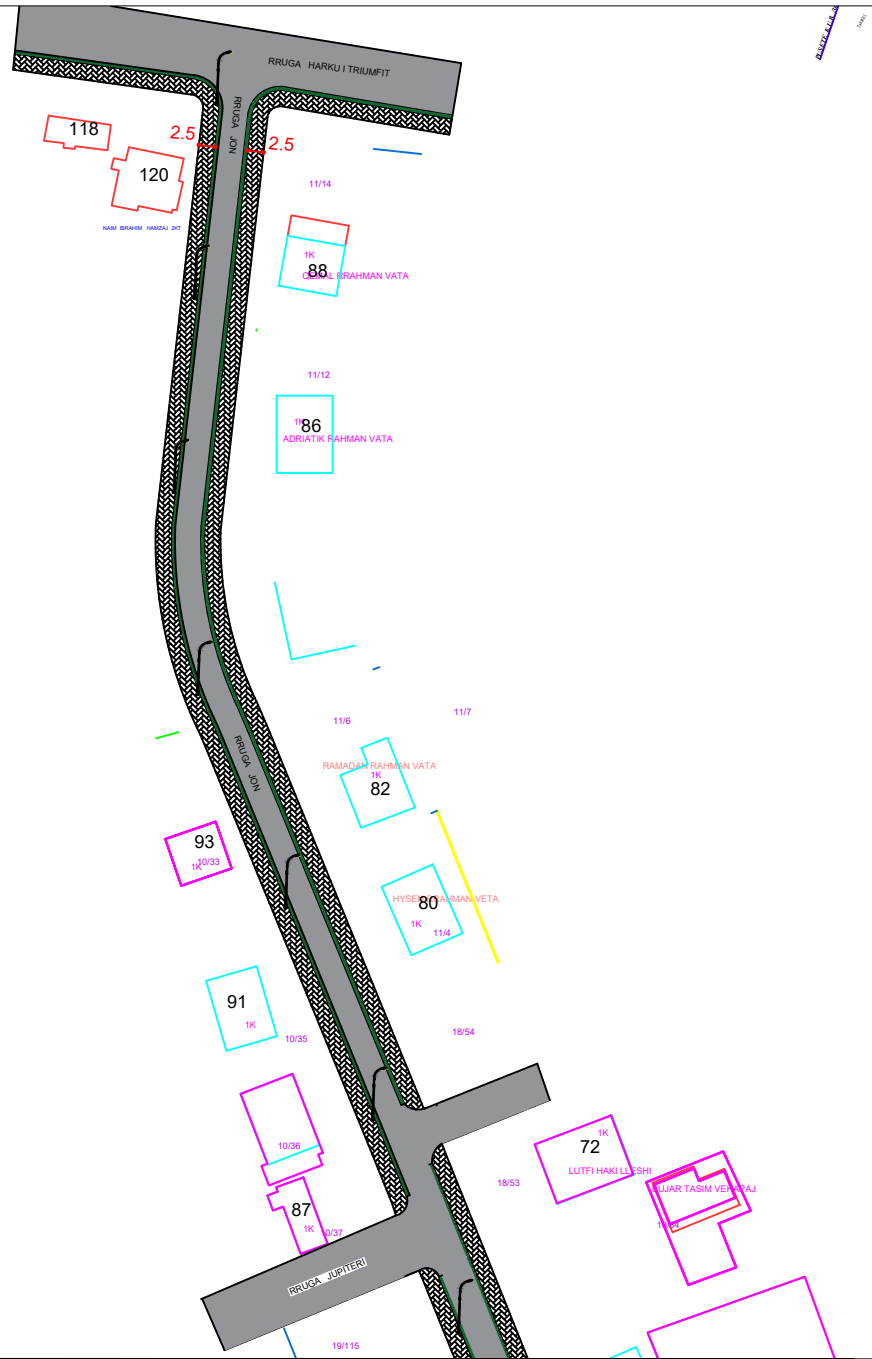

BASHKIA KAMEZ
 DREJTORIA E SHERBIMEVE PUBLIKE
 DREJTORIA E PROJEKTEVE DHE INVESTIMEVE
 DEPARTAMENTI I PROJEKTEVE

Dr. i Pergj. i Sherbimeve Publike	ELVIS GJIKA
Dr. e Projekteve e Investimeve	FLORA MUÇA

STAFI TEKNIK PROJEKTUES	Ing. Konstruktor	EMANUELA MEZIU
	Ing. Gjeoinformatik	ERBLIN LALA
	Ing. Preventivues	HAJREDIN MURGU
	Ing. Topograf	RAMADAN HYSA

Titulli i Projektit NDERTIMI TROTUAR+NDRICIM+KUB RRUGA "JONE" Valias		Titulli i Projektit PROJEKT ZBATIMI
Emertimi i Fletes		Shkalla e Vizatimit

PLANIMETRI TROTUAR+NDRICIM	Fleta Nr. A-01
----------------------------	--------------------------

PLANIMETRI TROTUAR+NDRICIM L = 800 ML

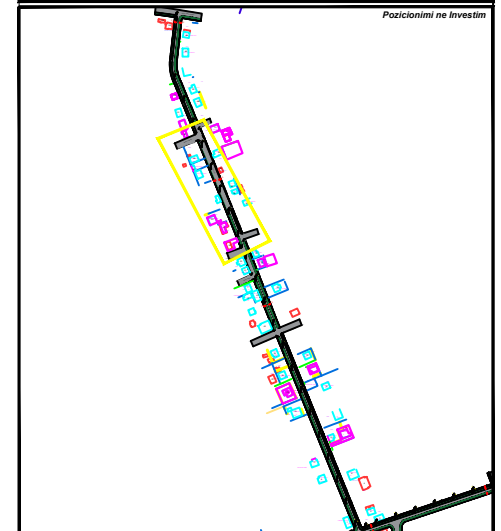
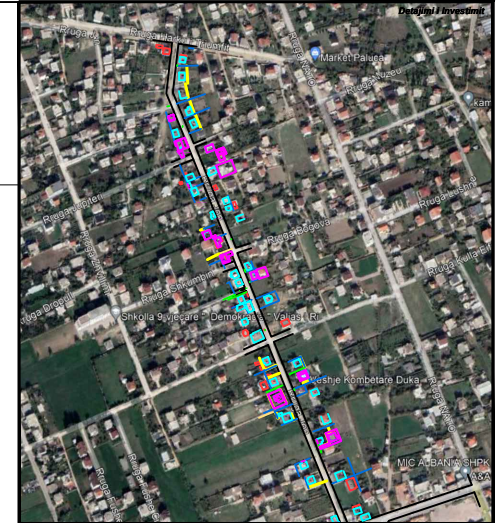
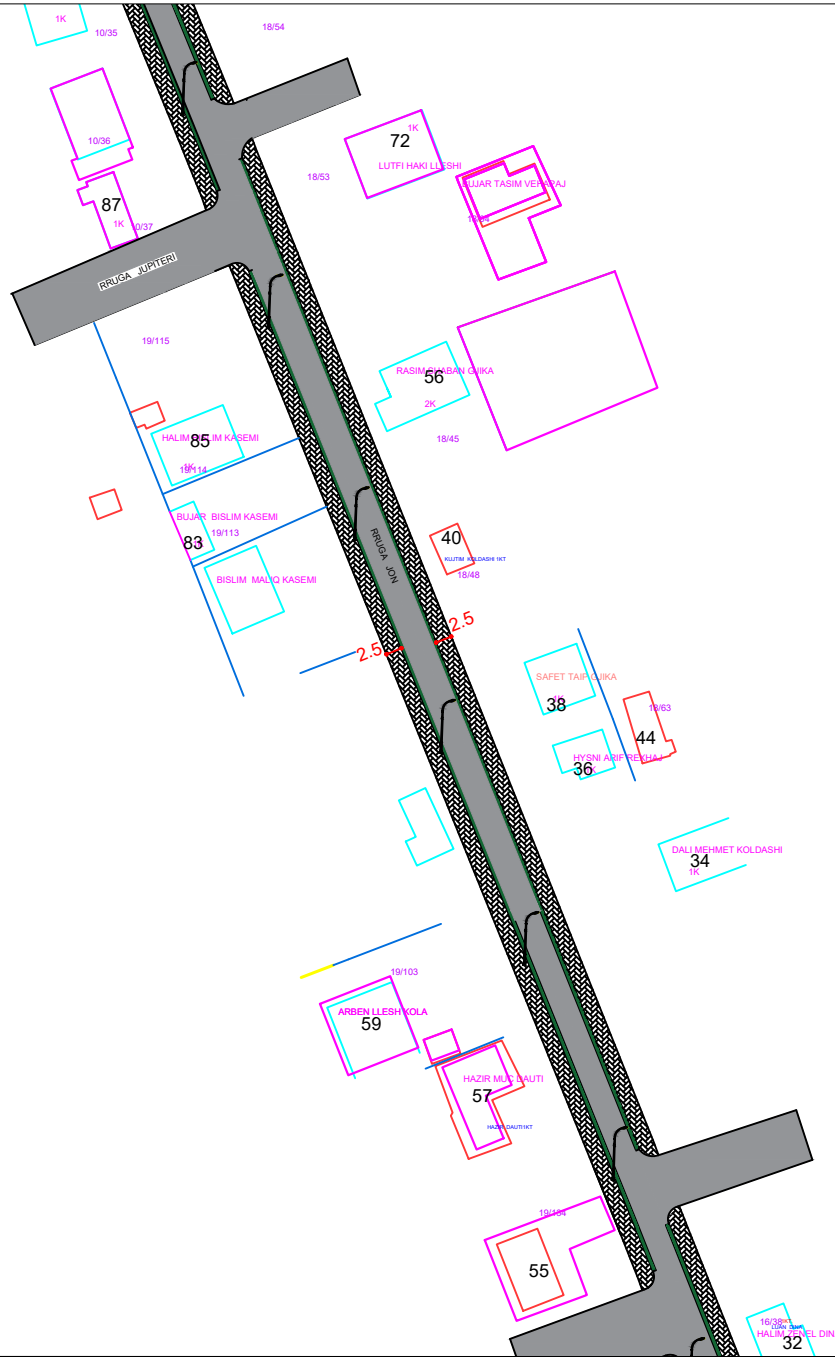

BASHKIA KAMEZ
 DREJTORIA E SHERBIMEVE PUBLIKE
 DREJTORIA E PROJEKTEVE DHE INVESTIMEVE
 DEPARTAMENTI I PROJEKTEVE

Dr. i Pergj. i Sherbimeve Publike	ELVIS GJIKA
Dr. e Projekteve e Investimeve	FLORA MUÇA

STAFI TEKNIK PROJEKTUES	Ing. Konstruktor	EMANUELA MEZIU
	Ing. Gjeoinformatik	ERBLIN LALA
	Ing. Preventivues	HAJREDIN MURGU
	Ing. Topograf	RAMADAN HYSA

Titulli i Projektit		Titulli i Projektit
NDERTIMI TROTUAR+NDRICIM+KUB RRUGA "JONE" Valias		PROJEKT ZBATIMI
Data e Implementimit :		Shkalla e Vizatimit

Emertimi i Fletes		Fleta Nr.
PLANIMETRI TROTUAR+NDRICIM		A-02

PLANIMETRI TROTUAR+NDRICIM L= 800 ML

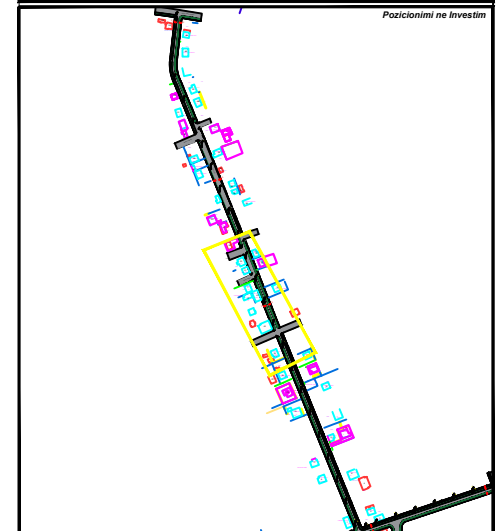
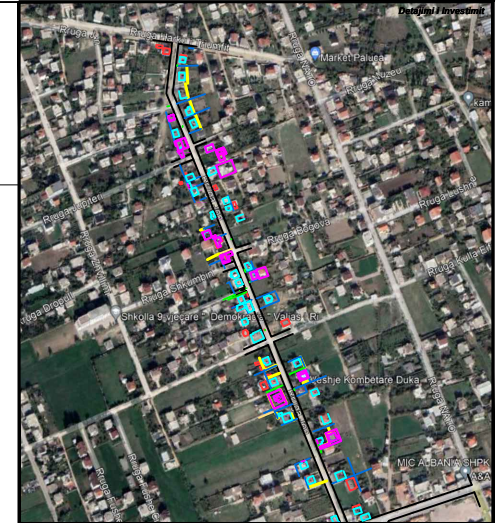
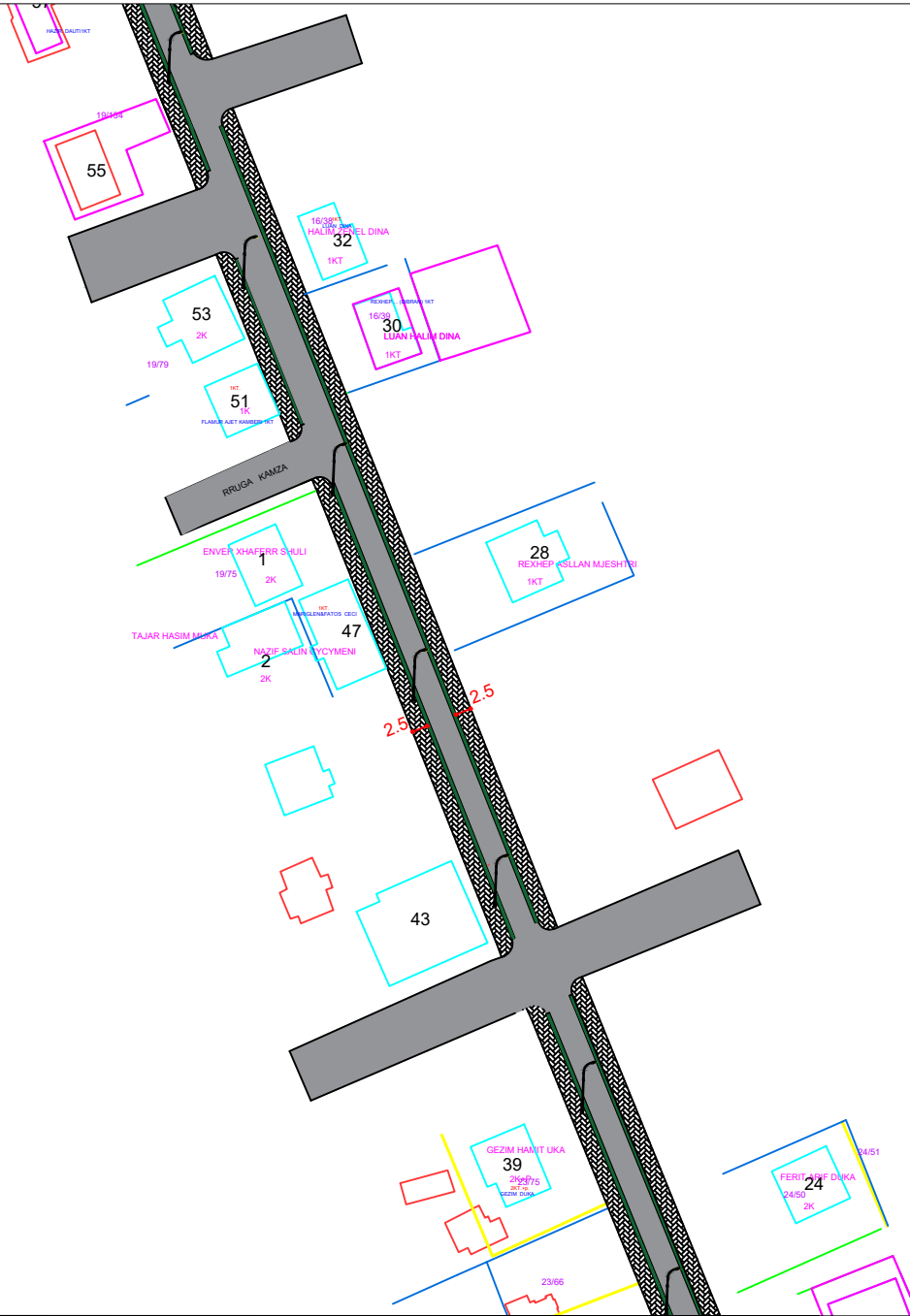

BASHKIA KAMEZ
DREJTORIA E SHERBIMEVE PUBLIKE
DREJTORIA E PROJEKTEVE DHE INVESTIMEVE
DEPARTAMENTI I PROJEKTEVE

Dr. i Pergj. i Sherbimeve Publike	ELVIS GJIKA
Dr. e Projekteve e Investimeve	FLORA MUÇA

STAFI TEKNIK PROJEKTUES	Ing. Konstruktor	EMANUELA MEZIU
	Ing. Gjeoinformatik	ERBLIN LALA
	Ing. Preventivues	HAJREDIN MURGU
	Ing. Topograf	RAMADAN HYSA

Titulli i Projektit		Faza e Projektit PROJEKT ZBATIMI
NDERTIMI TROTUAR+NDRICIM+KUB RRUGA "JONE" Valias		
Data e Implementimit :		Shkalla e Vizatimit
Emertimi i Fletes		

PLANIMETRI TROTUAR+NDRICIM	Fleta Nr. A-03
----------------------------	--------------------------

PLANIMETRI TROTUAR+NDRICIM L = 800 ML

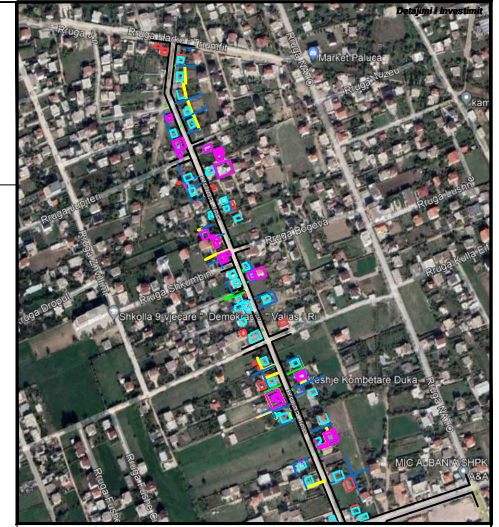
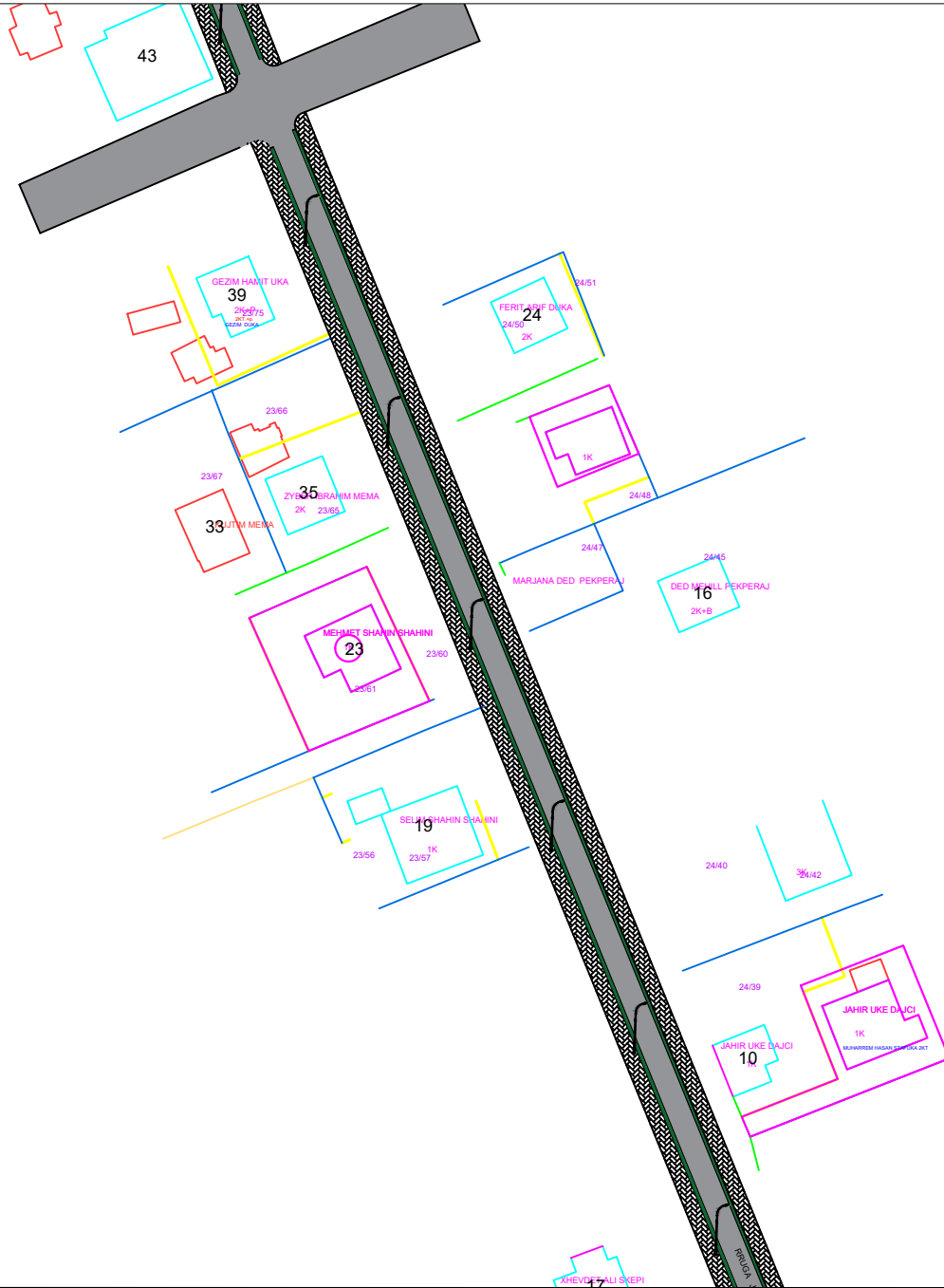

BASHKIA KAMEZ
DREJTORIA E SHERBIMEVE PUBLIKE
DREJTORIA E PROJEKTEVE DHE INVESTIMEVE
DEPARTAMENTI I PROJEKTEVE

Dr. i Pergi. i Sherbimeve Publike	ELVIS GJIKA
Dr. e Projekteve e Investimeve	FLORA MUÇA

STAFI TEKNIK PROJEKTUES	Ing. Konstruktor	EMANUELA MEZIU
	Ing. Gjeoinformatik	ERBLIN LALA
	Ing. Preventivues	HAJREDIN MURGU
	Ing. Topograf	RAMADAN HYSA

Titulli i Projektit NDERTIMI TROTUAR+NDRICIM+KUB RRUGA "JONE" Valias		Projekti ZBATIMIT
Data e Implementimit :		Shkalla e Vizatimit :

Emertimi i Fletes PLANIMETRI TROTUAR+NDRICIM		Fleta Nr. A-04
---	--	--------------------------

PLANIMETRI TROTUAR+NDRICIM L= 580 ML

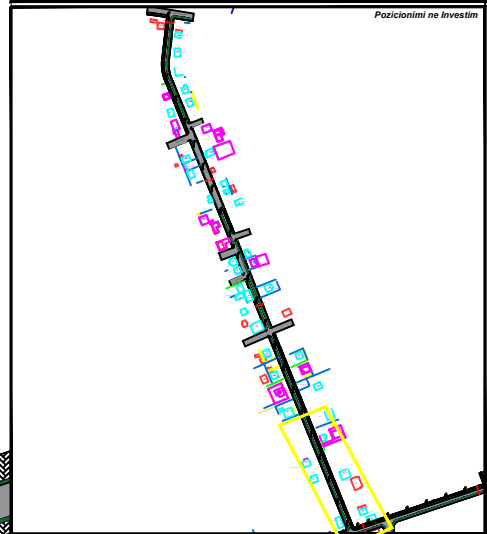
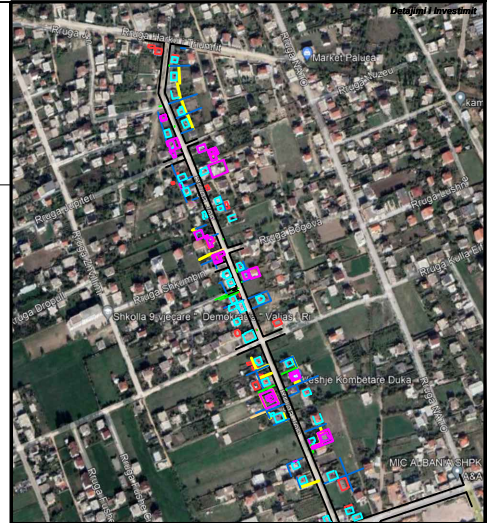
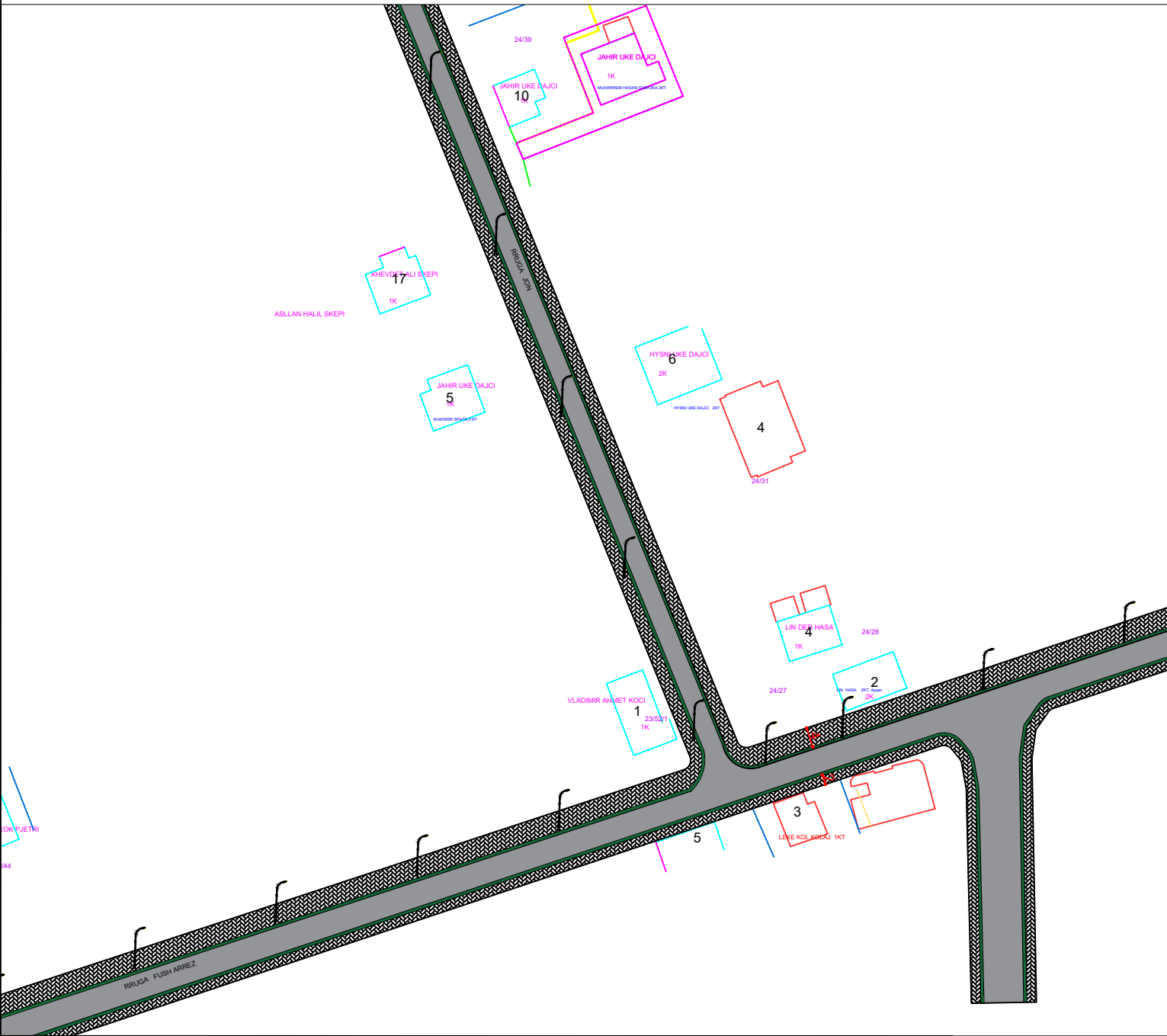

BASHKIA KAMEZ
DREJTORIA E SHERBIMEVE PUBLIKE
DREJTORIA E PROJEKTEVE DHE INVESTIMEVE
DEPARTAMENTI I PROJEKTEVE

Dr. i Pergj. i Sherbimeve Publike: ELVIS GJIKJA
Dr. e Projekteve e Investimeve: FLORA MUÇA

STAFI TEKNIK PROJEKTES	Ing. Konstruktor	EMANUELA MEZIU
	Ing. Gjeoinformatik	ERBLIN LALA
	Ing. Preventivues	HAJREDIN MURGU
	Ing. Topograf	RAMADAN HYSA

Titulli i Projektit: **NDERTIMI TROTUAR+NDRICIM+KUB**
RRUGA "JONE" Valias

Emertimi i Fletes: **PLANIMETRI TROTUAR+NDRICIM**

Faza e Projektit: **PROJEKT ZBATIMI**
Data e Implementimit :
Shkalla e Vizatimit :
Fleta Nr.: **A-05**

PLANIMETRI TROTUAR+NDRICIM L= 580 ML

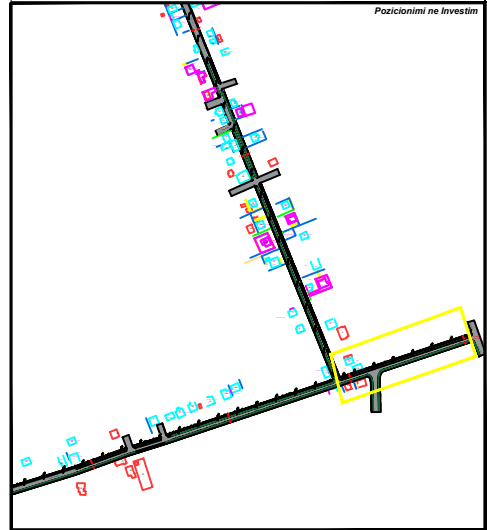
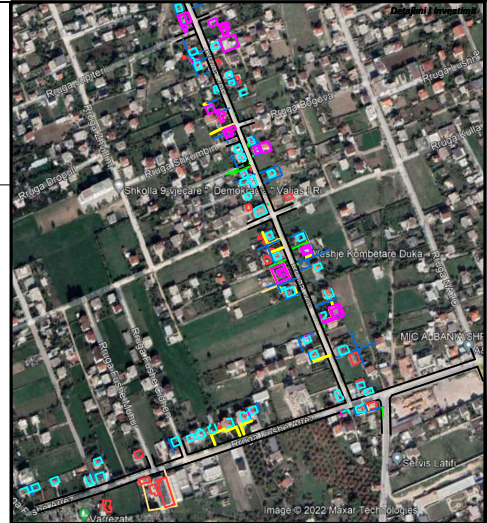
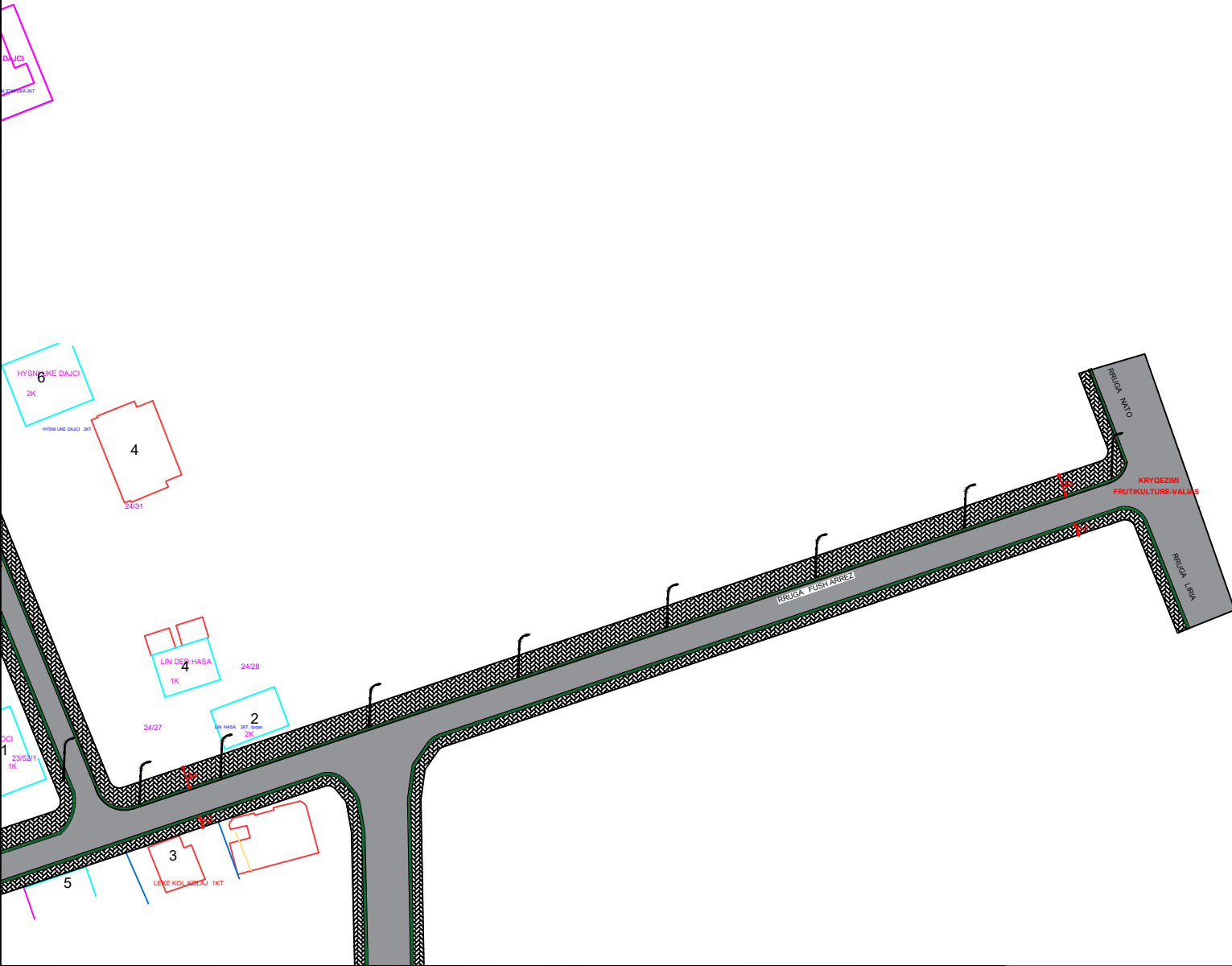

BASHKIA KAMEZ
 DREJTORIA E SHERBIMEVE PUBLIKE
 DREJTORIA E PROJEKTEVE DHE INVESTIMEVE
 DEPARTAMENTI I PROJEKTEVE

Dr. i Pergj. i Sherbimeve Publike ELVIS GJIKA
 Dr. e Projekteve e Investimeve FLORA MUÇA

STAFI TEKNIK PROJEKTES	Ing. Konstruktor	EMANUELA MEZIU
	Ing. Gjeoinformatik	ERBLIN LALA
	Ing. Preventivues	HAJREDIN MURGU
	Ing. Topograf	RAMADAN HYSA

Titulli i Projektit
**NDERTIMI TROTUAR+NDRICIM+KUB
 RRUGA "FUSHE ARREZ" Valias**

Faza e Projektit
PROJEKT ZBATIMI

Data e Implementimit :

Shkalla e Vizatimit

Emertimi i Fletes
 PLANIMETRI TROTUAR+NDRICIM

Fleta Nr.
A-06

PLANIMETRI TROTUAR+NDRICIM L = 580 ML

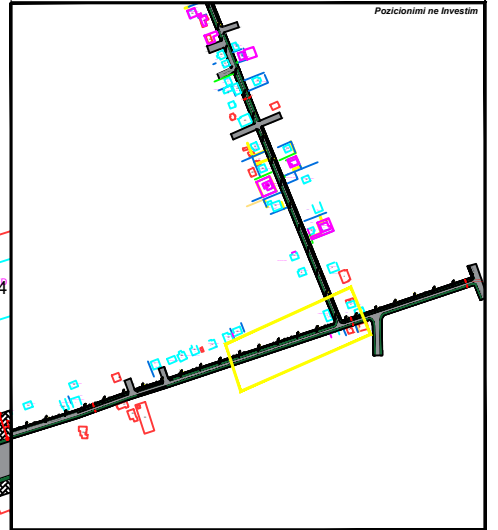
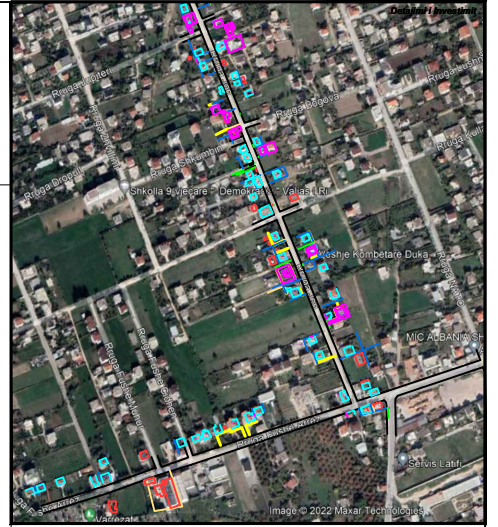
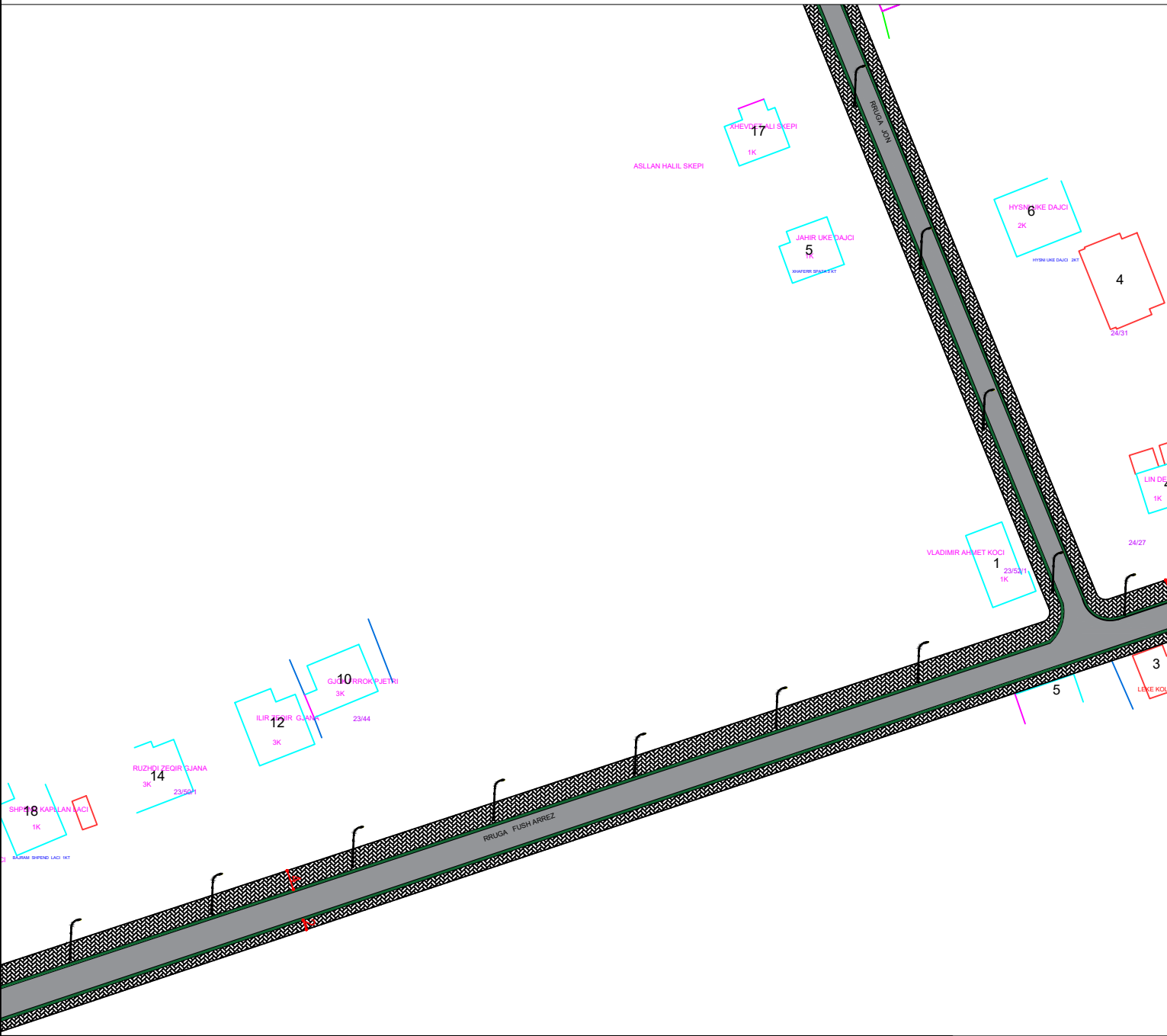

BASHKIA KAMEZ

DREJTORIA E SHERBIMEVE PUBLIKE
DREJTORIA E PROJEKTEVE DHE INVESTIMEVE
DEPARTAMENTI I PROJEKTEVE

Dr. i Pergi. i Sherbimeve Publike ELVIS GJIKJA
Dr. e Projekteve e Investimeve FLORA MUÇA

STAFI TEKNIK PROJEKTES	Ing. Konstruktor	EMANUELA MEZIU
	Ing. Gjeoinformatik	ERBLIN LALA
	Ing. Preventivues	HAJREDIN MURGU
	Ing. Topograf	RAMADAN HYSA

Titulli i Projektit
NDERTIMI TROTUAR+NDRICIM+KUB
RRUGA "FUSHE ARREZ" Valias

Faza e Projektit
PROJEKT ZBATIMI

Data e Implementimit :

Emertimi i Fletes
PLANIMETRI TROTUAR+NDRICIM

Shkalla e Vizatimit

Fleta Nr.
A-07

PLANIMETRI TROTUAR+NDRICIM L= 580 ML

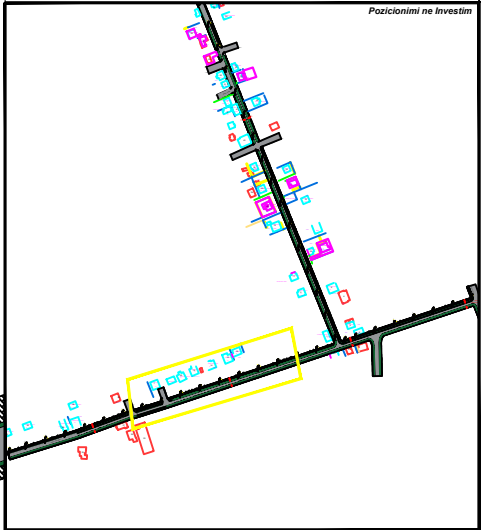
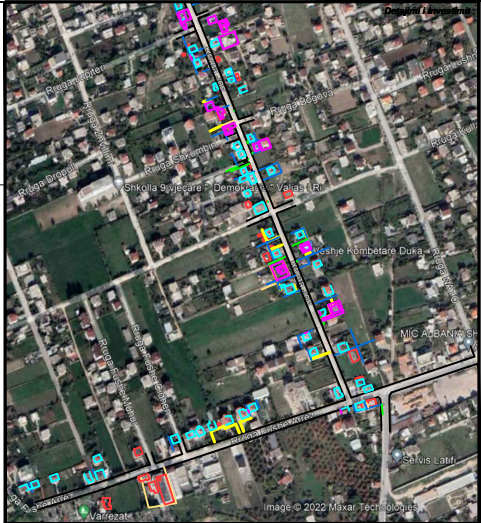
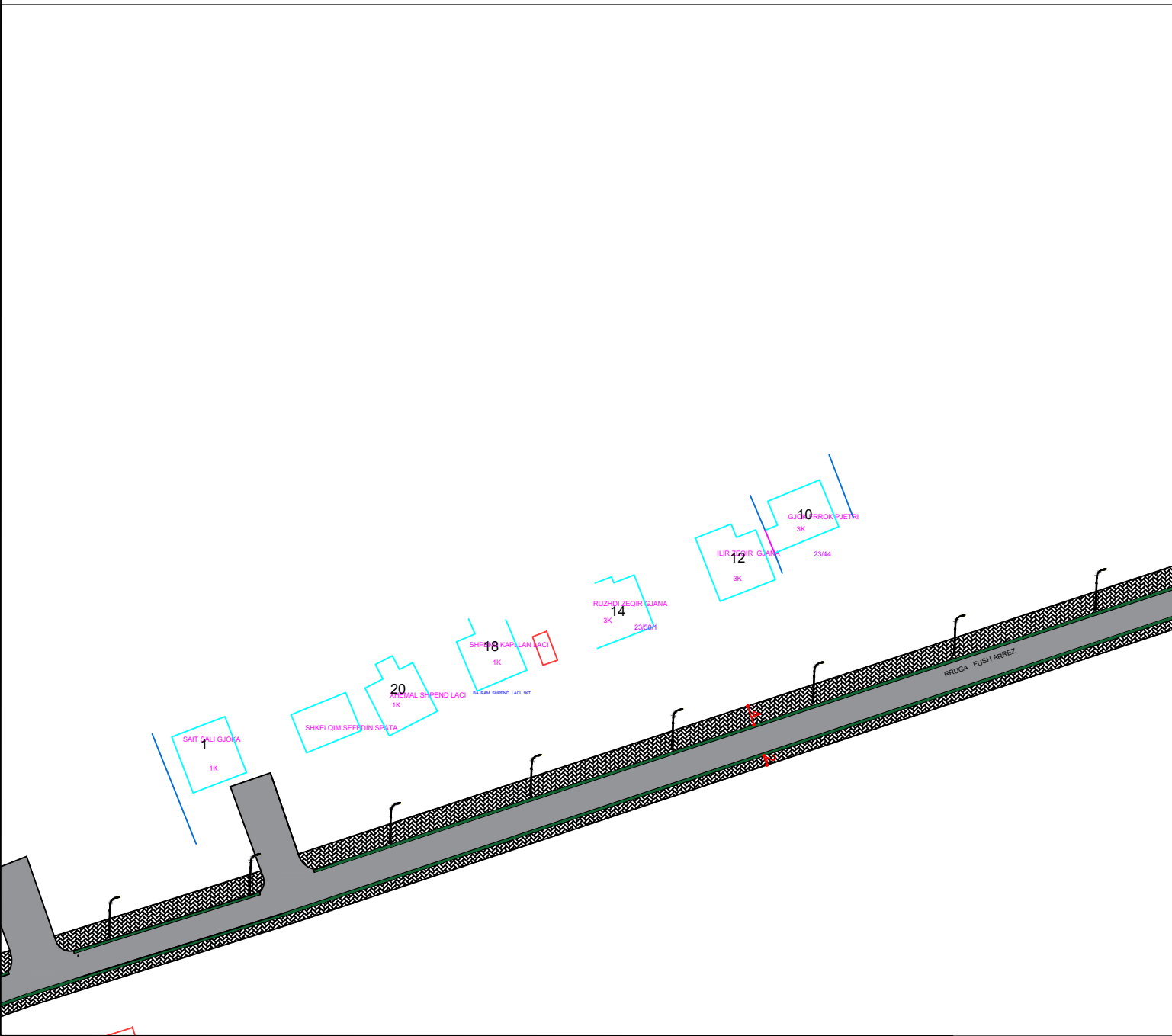

BASHKIA KAMEZ
 DREJTORIA E SHERBIMEVE PUBLIKE
 DREJTORIA E PROJEKTEVE DHE INVESTIMEVE
 DEPARTAMENTI I PROJEKTEVE

Dr. i Pergj. i Sherbimeve Publike ELVIS GJIKA
 Dr. e Projekteve e Investimeve FLORA MUÇA

STAFI TEKNIK PROJEKTUES	Ing. Konstruktor	EMANUELA MEZIU
	Ing. Gjeoinformatik	ERBLIN LALA
	Ing. Preventivues	HAJREDIN MURGU
	Ing. Topograf	RAMADAN HYSA

Titulli i Projektit
 NDERTIMI TROTUAR+NDRICIM+KUB
 RRUGA "FUSHE ARREZ" Valias

Emertimi i Fletes
 PLANIMETRI TROTUAR+NDRICIM

Faza e Projektit
 PROJEKT ZBATIMI
Data e Implementimit :
Shkalla e Vizatimit
 Fleta Nr.
A-08

PLANIMETRI TROTUAR+NDRICIM L= 580 ML

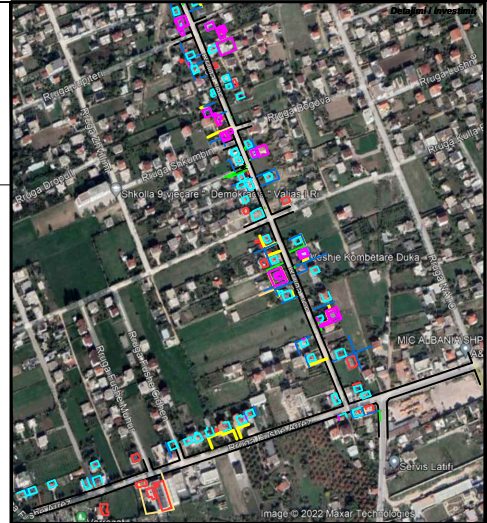
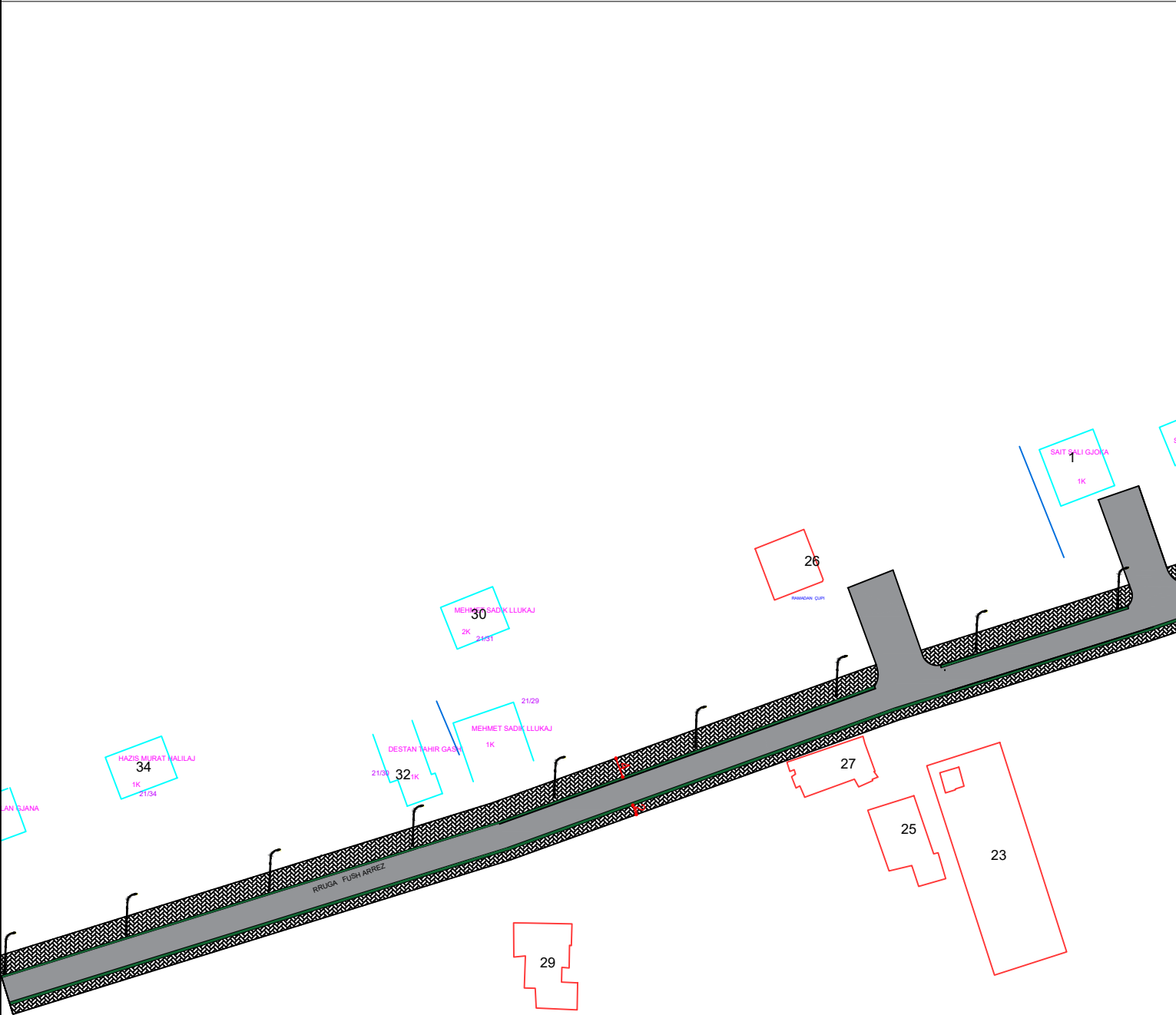

BASHKIA KAMEZ
 DREJTORIA E SHERBIMEVE PUBLIKE
 DREJTORIA E PROJEKTEVE DHE INVESTIMEVE
 DEPARTAMENTI I PROJEKTEVE

Dr. i Pergj. i Sherbimeve Publike ELVIS GJIKJA
 Dr. e Projekteve e Investimeve FLORA MUÇA

STAFI TEKNIK PROJEKTUES	Ing. Konstruktor	EMANUELA MEZIU
	Ing. Gjeoinformatik	ERBLIN LALA
	Ing. Preventivues	HAJREDIN MURGU
	Ing. Topograf	RAMADAN HYSA

Titulli i Projektit
PROJEKT ZBATIMI
Data e Implementimit :
 NDERTIMI TROTUAR+NDRICIM+KUB
 RRUGA "FUSH ARREZ" Valias

Emertimi i Fletes
 PLANIMETRI TROTUAR+NDRICIM

Shkalla e Vizatimit
 Fleta Nr.
A-09

PLANIMETRI KUB

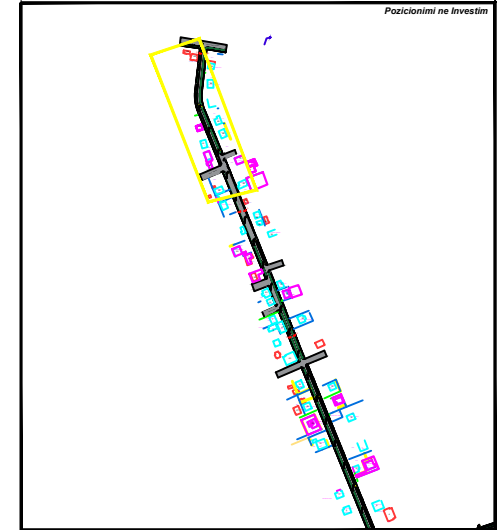
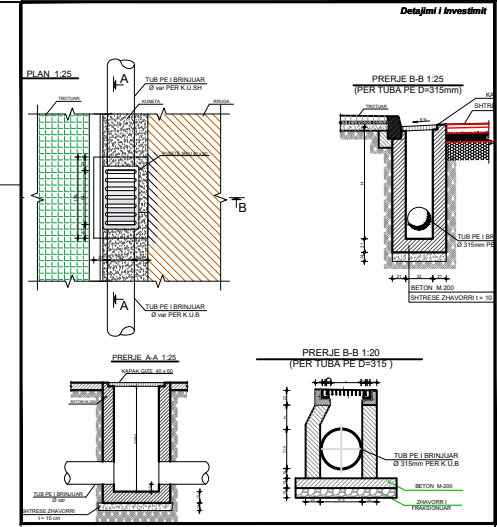
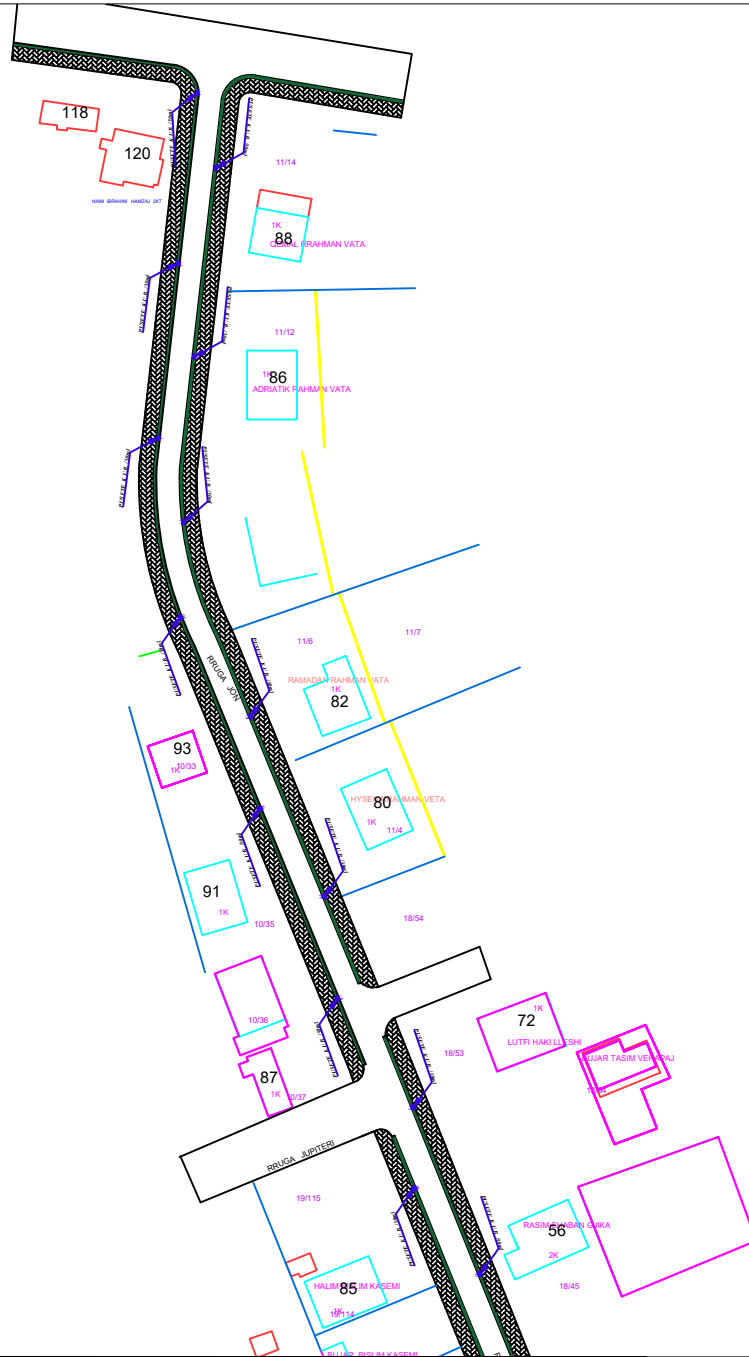

BASHKIA KAMEZ
 DREJTORIA E SHERBIMEVE PUBLIKE
 DREJTORIA E PROJEKTEVE DHE INVESTIMEVE
 DEPARTAMENTI I PROJEKTEVE

Dr. i Pergi. i Sherbimeve Publike ELVIS GJIKA
 Dr. e Projekteve e Investimeve FLORA MUÇA

STAFI TEKNIK PROJEKTES	Ing. Konstruktor	EMANUELA MEZIU
	Ing. Gjeoinformatik	ERBLIN LALA
	Ing. Preventivues	HAJREDIN MURGU
	Ing. Topograf	RAMADAN HYSA

Titulli i Projektit
 NDERTIMI TROTUAJ+NDRICIM+KUB
 RRUGA "JON+FUSHE ARREZ" Valias

Faza e Projektit
 PROJEKT ZBATIMI

Data e Implementimit :

Shkalla e Vizatimit

Emertimi i Fletes
 PLANIMETRI KUB

Fleta Nr.
 A-10

PLANIMETRI KUB

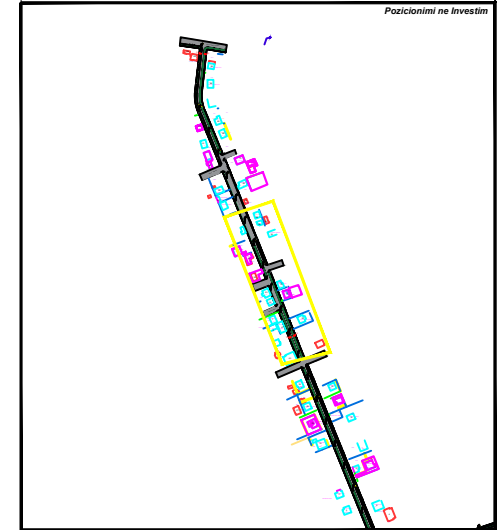
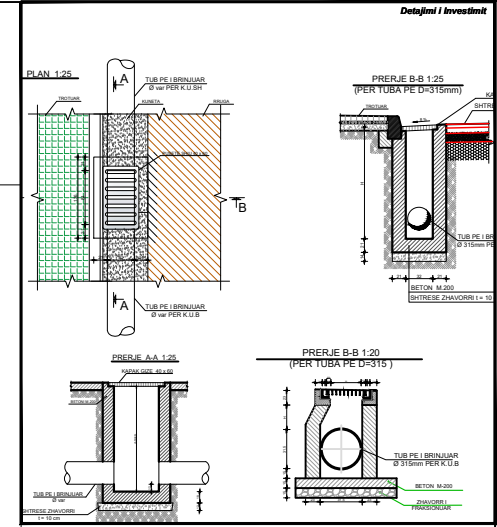
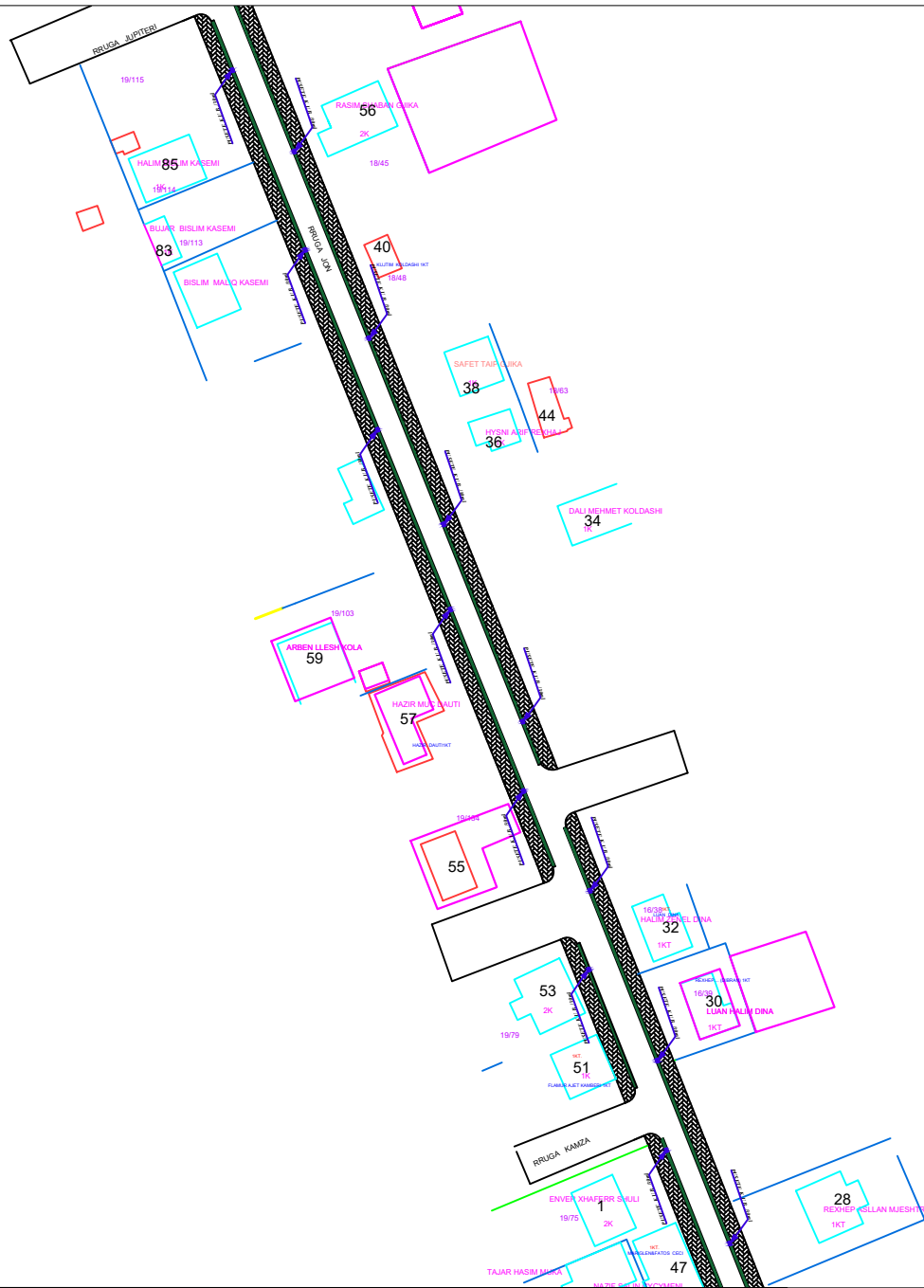

BASHKIA KAMEZ
 DREJTORIA E SHERBIMEVE PUBLIKE
 DREJTORIA E PROJEKTEVE DHE INVESTIMEVE
 DEPARTAMENTI I PROJEKTEVE

Dr. i Pergj. i Sherbimeve Publike	ELVIS GJIKI
Dr. e Projekteve e Investimeve	FLORA MUÇA

STAFI TEKNIK PROJEKTES	Ing. Konstruktor	EMANUELA MEZIU
	Ing. Gjeoinformatik	ERBLIN LALA
	Ing. Preventivues	HAJREDIN MURGU
	Ing. Topograf	RAMADAN HYSA

Titulli i Projektit NDERTIMI TROTUAR+NDRICIM+KUB RRUGA "JON+FUSHE ARREZ" Valias	
Faza e Projektit PROJEKT ZBATIMI	
Data e Implementimit :	
Shkalla e Vizatimit	

PLANIMETRI KUB	Emertimi i Fletes
	Fleta Nr. A-11

PLANIMETRI KUB

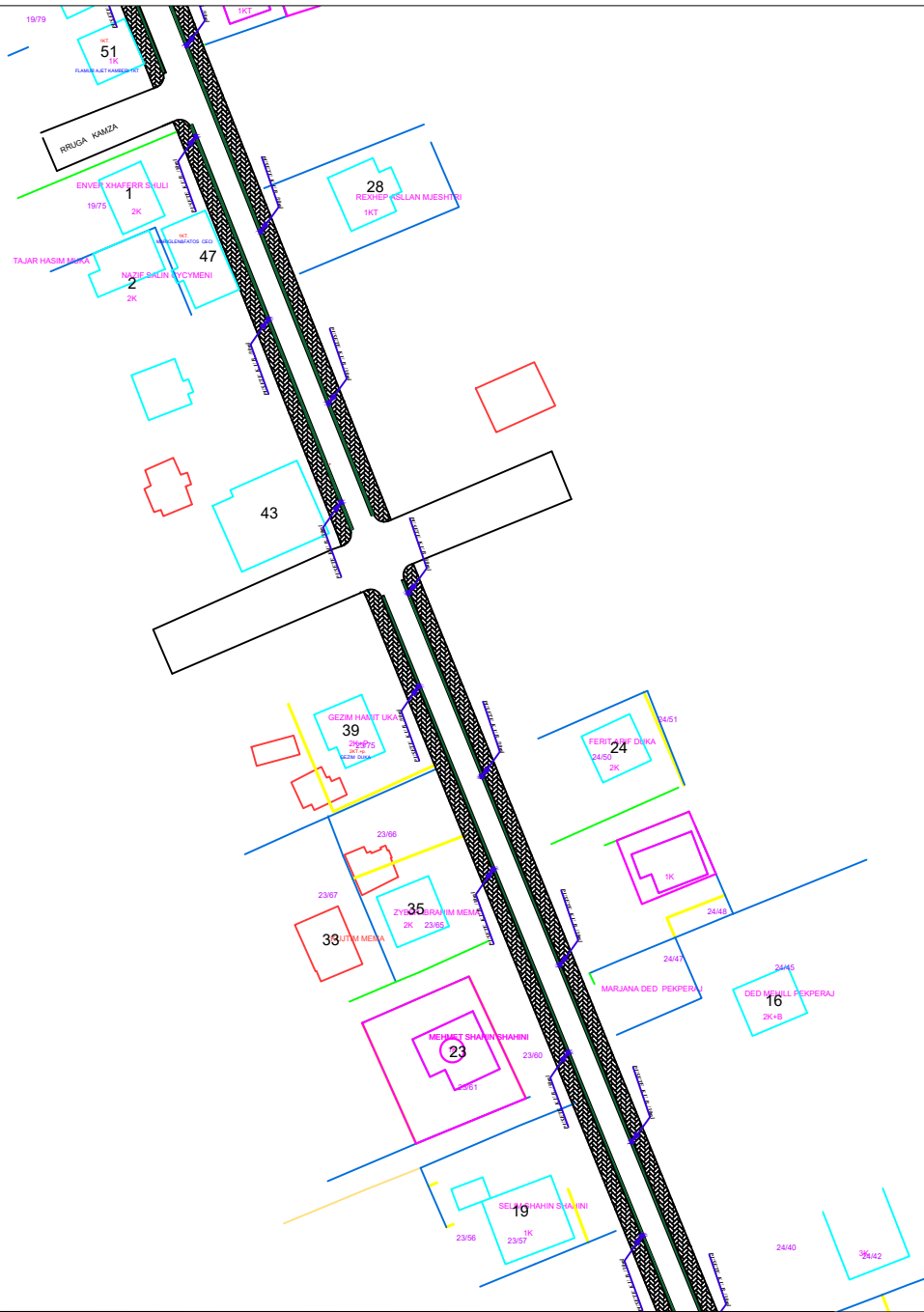

Detajli i Investimit

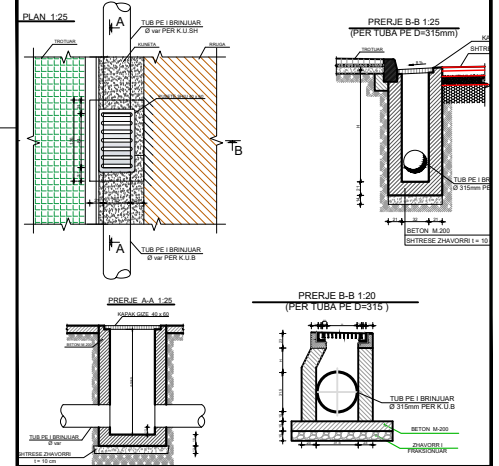

Pozicionimi ne Investim

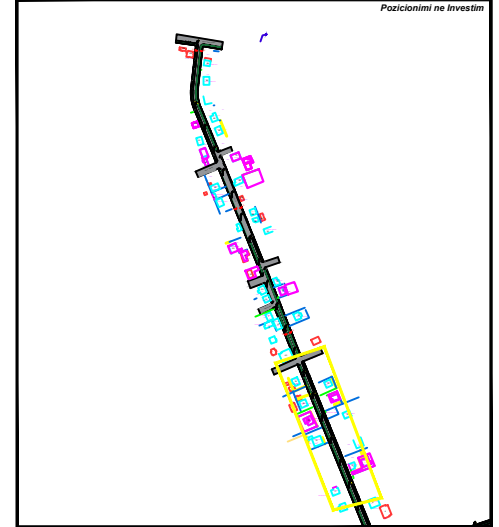

BASHKIA KAMEZ

DREJTORIA E SHERBIMEVE PUBLIKE
DREJTORIA E PROJEKTEVE DHE INVESTIMEVE
DEPARTAMENTI I PROJEKTEVE

Dr. i Pergj. i Sherbimeve Publike	ELVIS GJIKA
Dr. e Projekteve e Investimeve	FLORA MUÇA

STAFI TEKNIK PROJEKTES	Ing. Konstruktor	EMANUELA MEZIU
	Ing. Gjeoinformatik	ERBLIN LALA
	Ing. Preventivues	HAJREDIN MURGU
	Ing. Topograf	RAMADAN HYSA

Titulli i Projektit
**NDERTIMI TROTUAR+NDRICIM+KUB
RRUGA "JON+FUSHE ARREZ" Valias**

Faza e Projektit
PROJEKT ZBATIMI

Data e Implementimit :

Emertimi i Fletes	PLANIMETRI KUB
Shkalla e Vizatimit	
Fleta Nr.	A-12

PLANIMETRI KUB

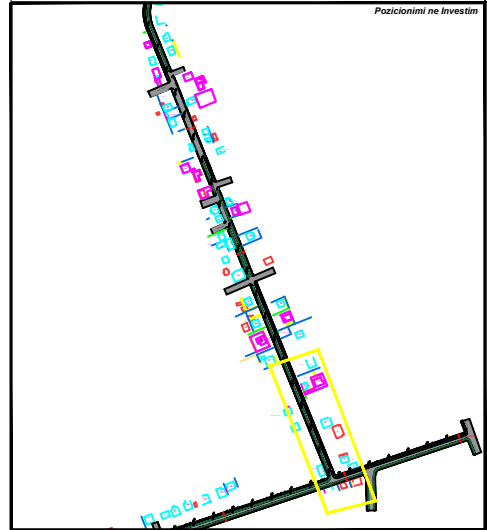
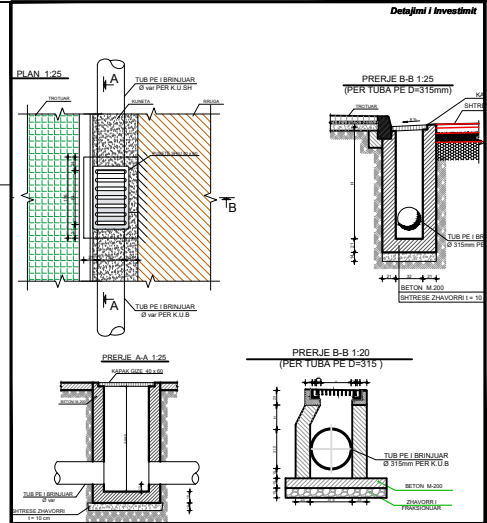

BASHKIA KAMEZ
 DREJTORIA E SHERBIMEVE PUBLIKE
 DREJTORIA E PROJEKTEVE DHE INVESTIMEVE
 DEPARTAMENTI I PROJEKTEVE

Dr. i Përgj. i Shërbimeve Publike	ELVIS GJIKA
Dr. e Projekteve e Investimeve	FLORA MUÇA

STAFI TEKNIK PROJEKTES	Ing. Konstruktor	EMANUELA MEZIU
	Ing. Gjeoinformatik	ERBLIN LALA
	Ing. Preventivues	HAJREDIN MURGU
	Ing. Topograf	RAMADAN HYSA

Titulli i Projektit
 NDERTIMI TROTUAR+NDRICIM+KUB
 RRUGA "JON+FUSHE ARREZ" Valias

PLANIMETRI KUB	Emertimi i Fletës	Faza e Projektit PROJEKT ZBATIMI
		Data e Implementimit :
	Shkalla e Vizatimit	Fleta Nr. A-13

PLANIMETRI KUB

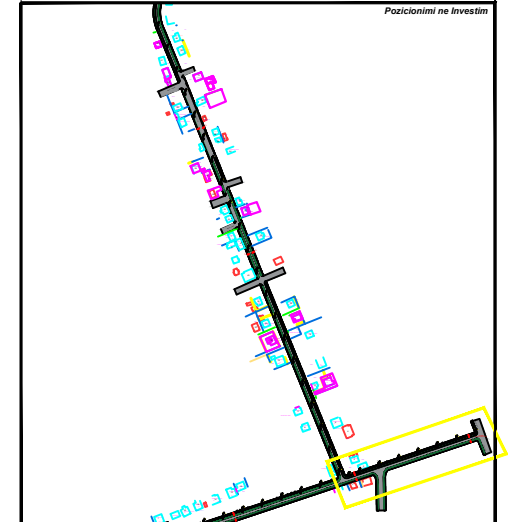
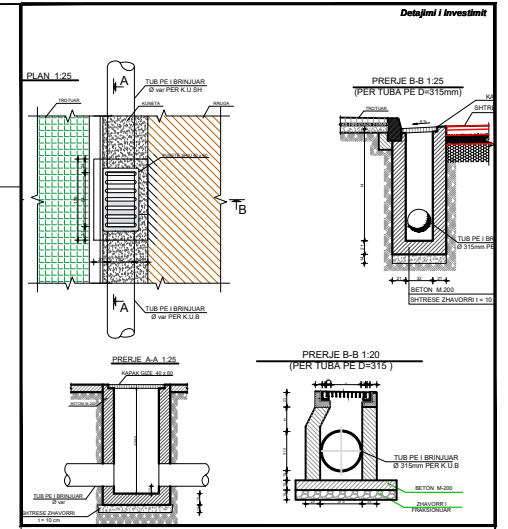
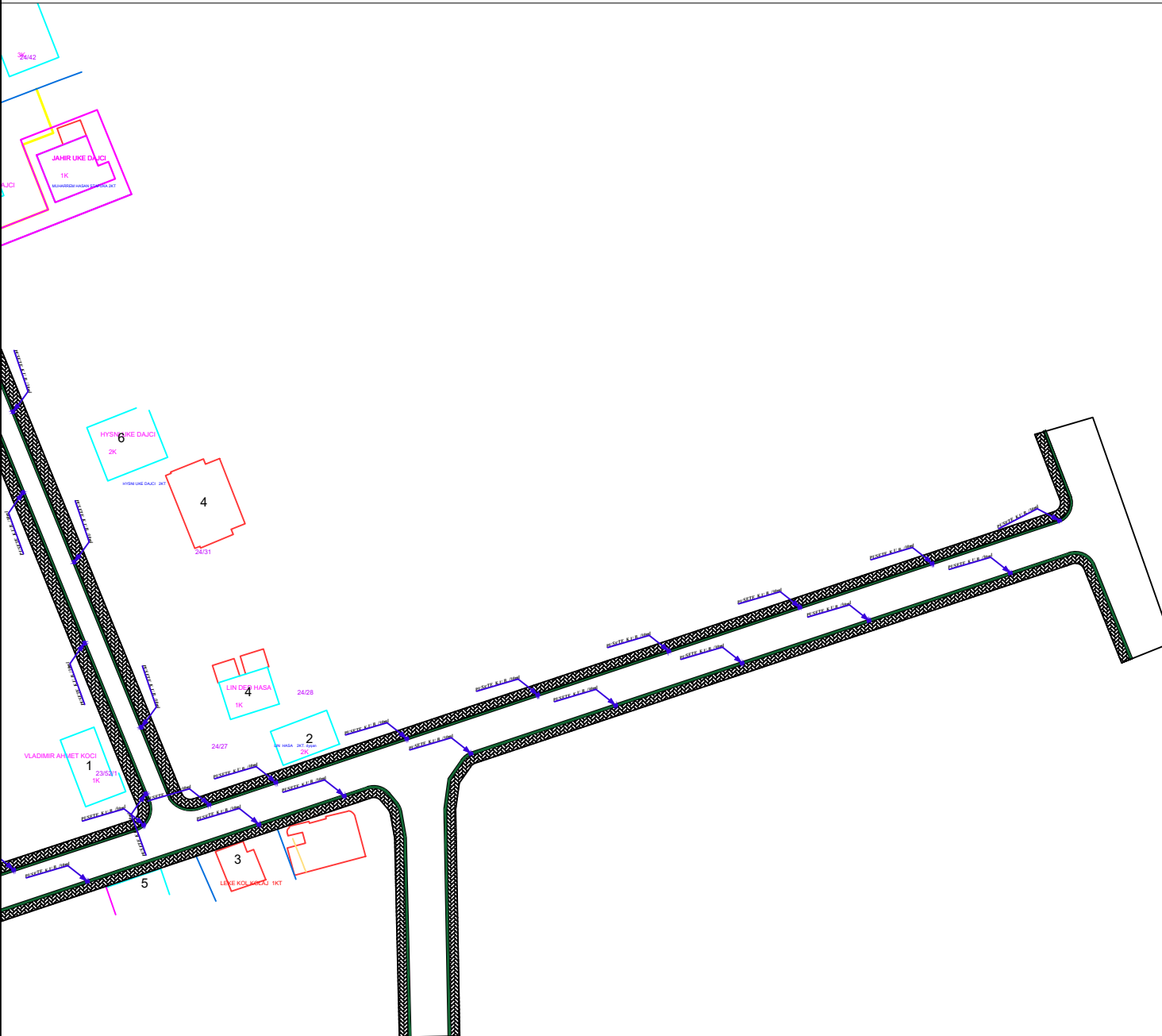

BASHKIA KAMEZ
 DREJTORIA E SHERBIMEVE PUBLIKE
 DREJTORIA E PROJEKTEVE DHE INVESTIMEVE
 DEPARTAMENTI I PROJEKTEVE

Dr. i Pergj. i Sherbimeve Publike ELVIS GJIKAJ
 Dr. e Projekteve e Investimeve FLORA MUÇAJ

STAFI TEKNIK PROJEKTES	Ing. Konstruktor	EMANUELA MEZIU
	Ing. Gjeoinformatik	ERBLIN LALA
	Ing. Preventivues	HAJREDIN MURGU
	Ing. Topograf	RAMADAN HYSA

Titulli i Projektit
PROJEKT ZBATIMI
Data e Implementimit :
 NDERTIMI TROTUAR+NDRICIM+KUB
 RRUGA "JON+FUSHE ARREZ" Valias

Shkalla e Vizatimit
 PLANIMETRI KUB
Fleta Nr.
A-14

PLANIMETRI KUB

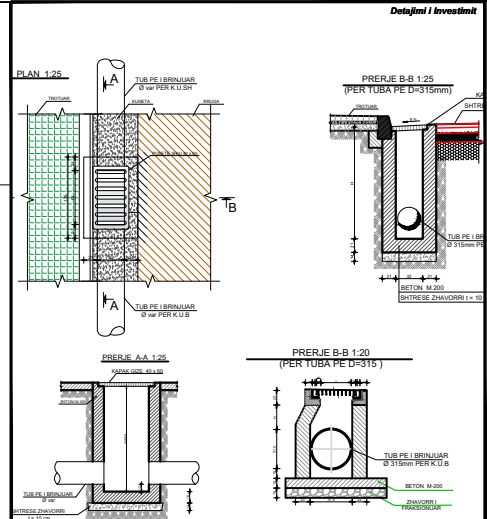
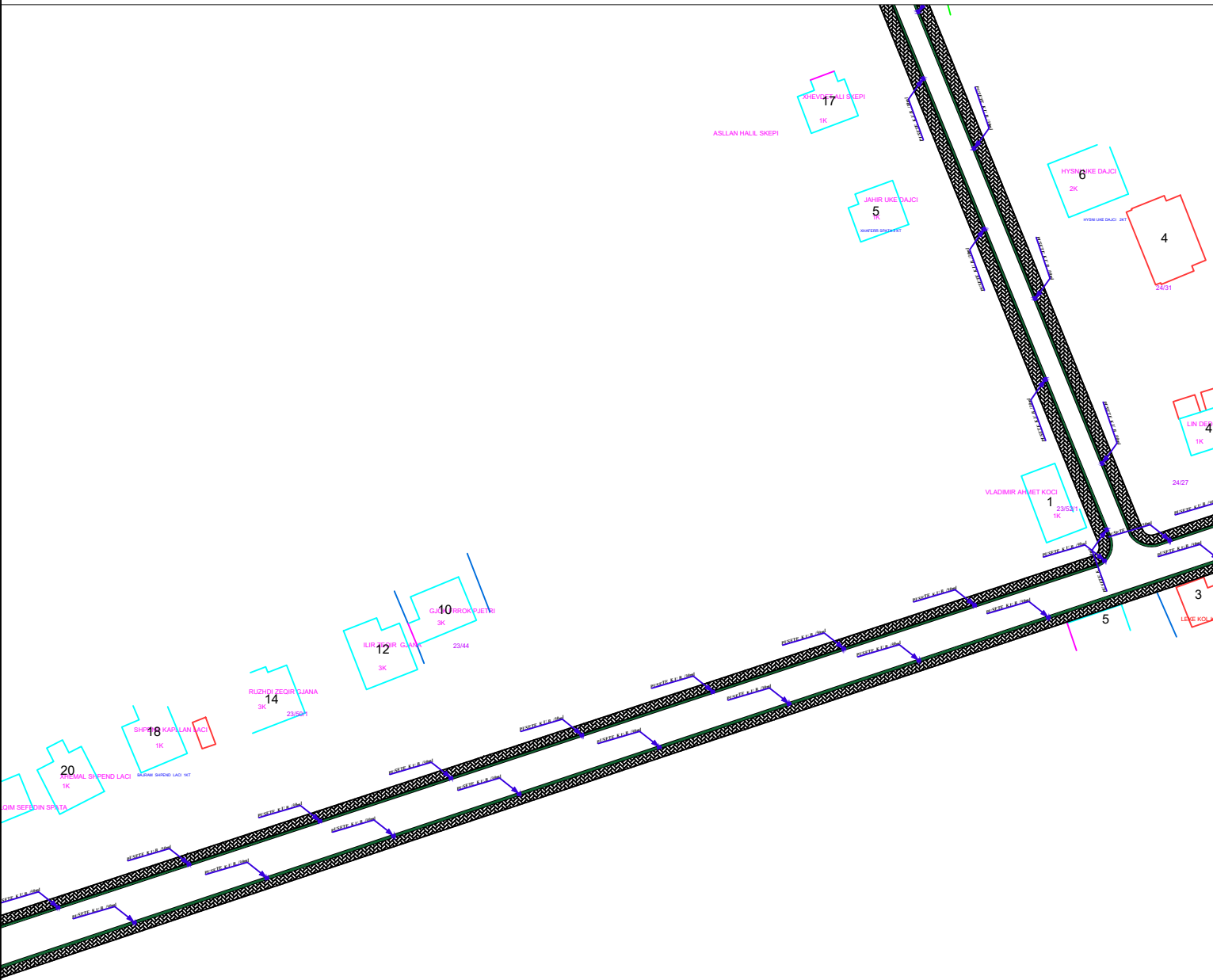

BASHKIA KAMEZ
 DREJTORIA E SHERBIMEVE PUBLIKE
 DREJTORIA E PROJEKTEVE DHE INVESTIMEVE
 DEPARTAMENTI I PROJEKTEVE

Dr. i Pergi. i Sherbimeve Publike ELVIS GJIKJA
 Dr. e Projekteve e Investimeve FLORA MUÇA

STAFI TEKNIK PROJEKTES	Ing. Konstruktor	EMANUELA MEZIU
	Ing. Gjeoinformatik	ERBLIN LALA
	Ing. Preventivues	HAJREDIN MURGU
	Ing. Topograf	RAMADAN HYSA

Titulli i Projektit
**NDERTIMI TROTUAR+NDRICIM+KUB
 RRUGA "JON+FUSHE ARREZ" Valias**

Faza e Projektit
PROJEKT ZBATIMI

Data e Implementimit :

Shkalla e Vizatimit

Emertimi i Fletes
 PLANIMETRI KUB

Fleta Nr.
A-15

PLANIMETRI KUB

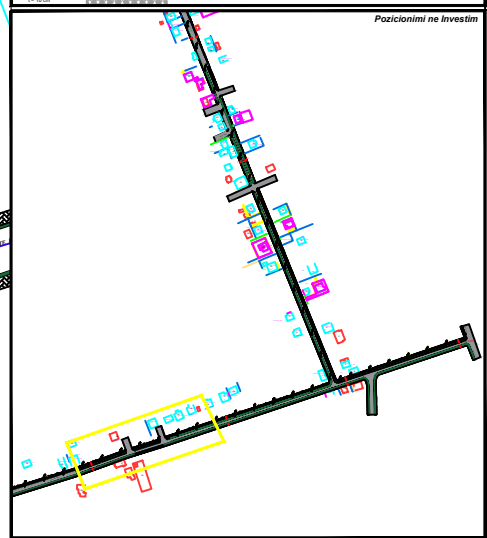
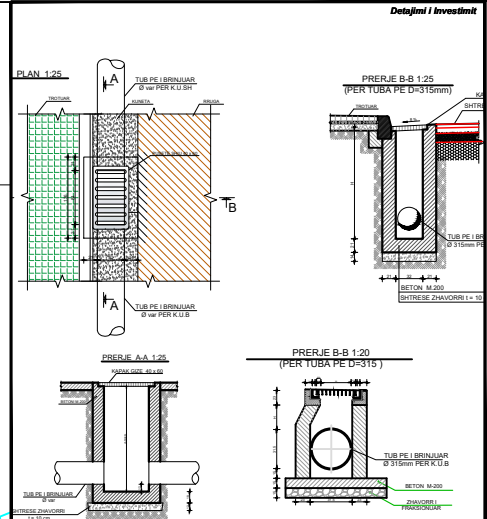
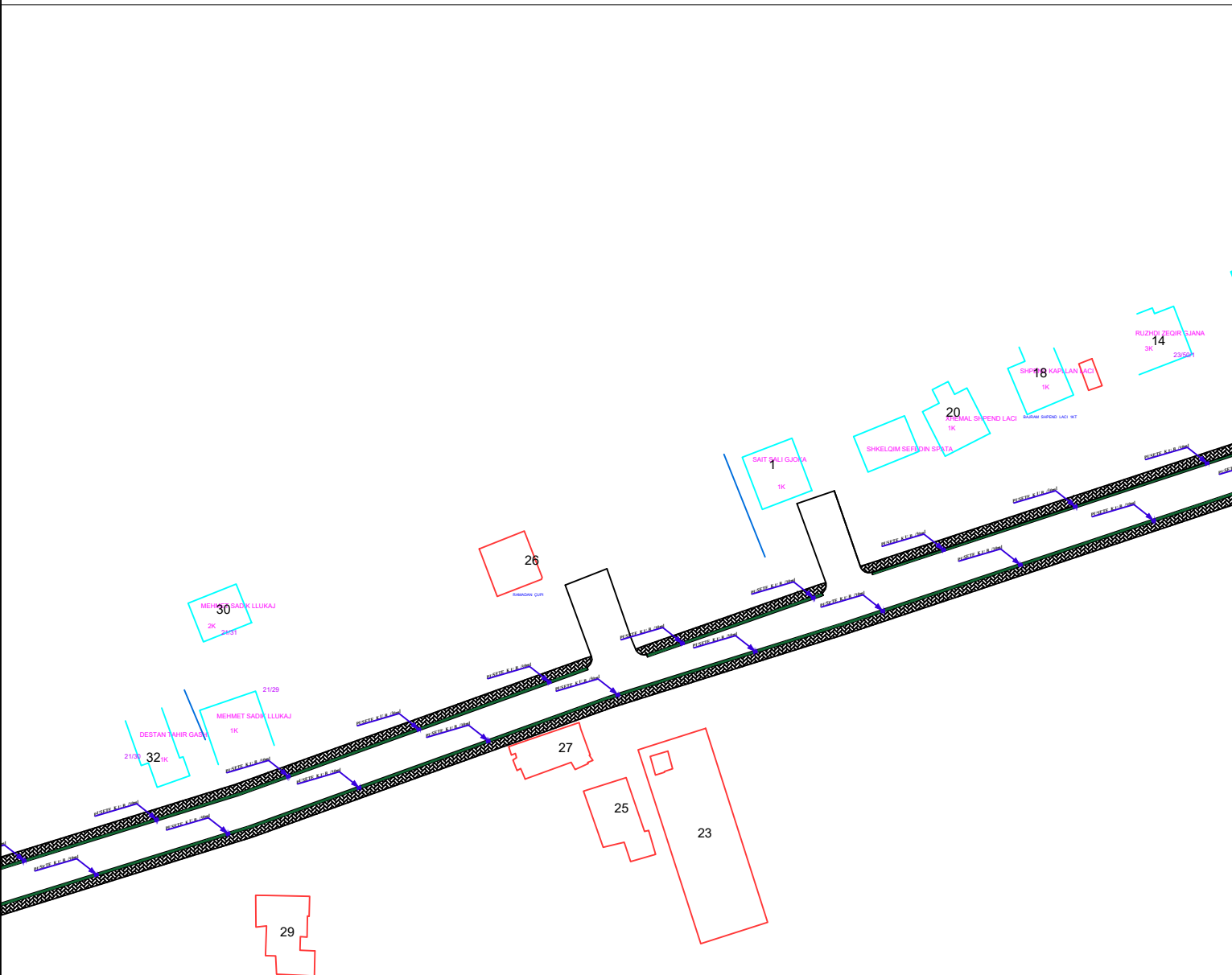

BASHKIA KAMEZ
 DREJTORIA E SHERBIMEVE PUBLIKE
 DREJTORIA E PROJEKTEVE DHE INVESTIMEVE
 DEPARTAMENTI I PROJEKTEVE

Dr. i Pergj. i Sherbimeve Publike ELVIS GJIKJA
 Dr. e Projekteve e Investimeve FLORA MUÇA

STAFI TEKNIK PROJEKTES	Ing. Konstruktor	EMANUELA MEZIU
	Ing. Gjeoinformatik	ERBLIN LALA
	Ing. Preventivues	HAJREDIN MURGU
	Ing. Topograf	RAMADAN HYSA

Titulli i Projektit
**NDERTIMI TROTUAR+NDRICIM+KUB
 RRUGA "JON+FUSHE ARREZ" Valias**

Faza e Projektit
PROJEKT ZBATIMI

Data e Implementimit :

Emertimi i Fletes
 PLANIMETRI KUB

Shkalla e Vizatimit
 Fleta Nr.
A-16

PLANIMETRI KUB

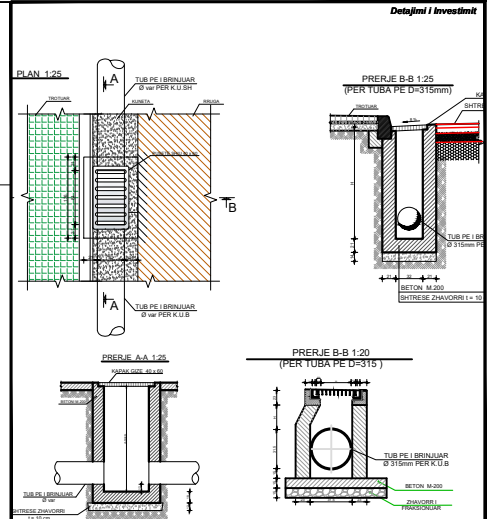
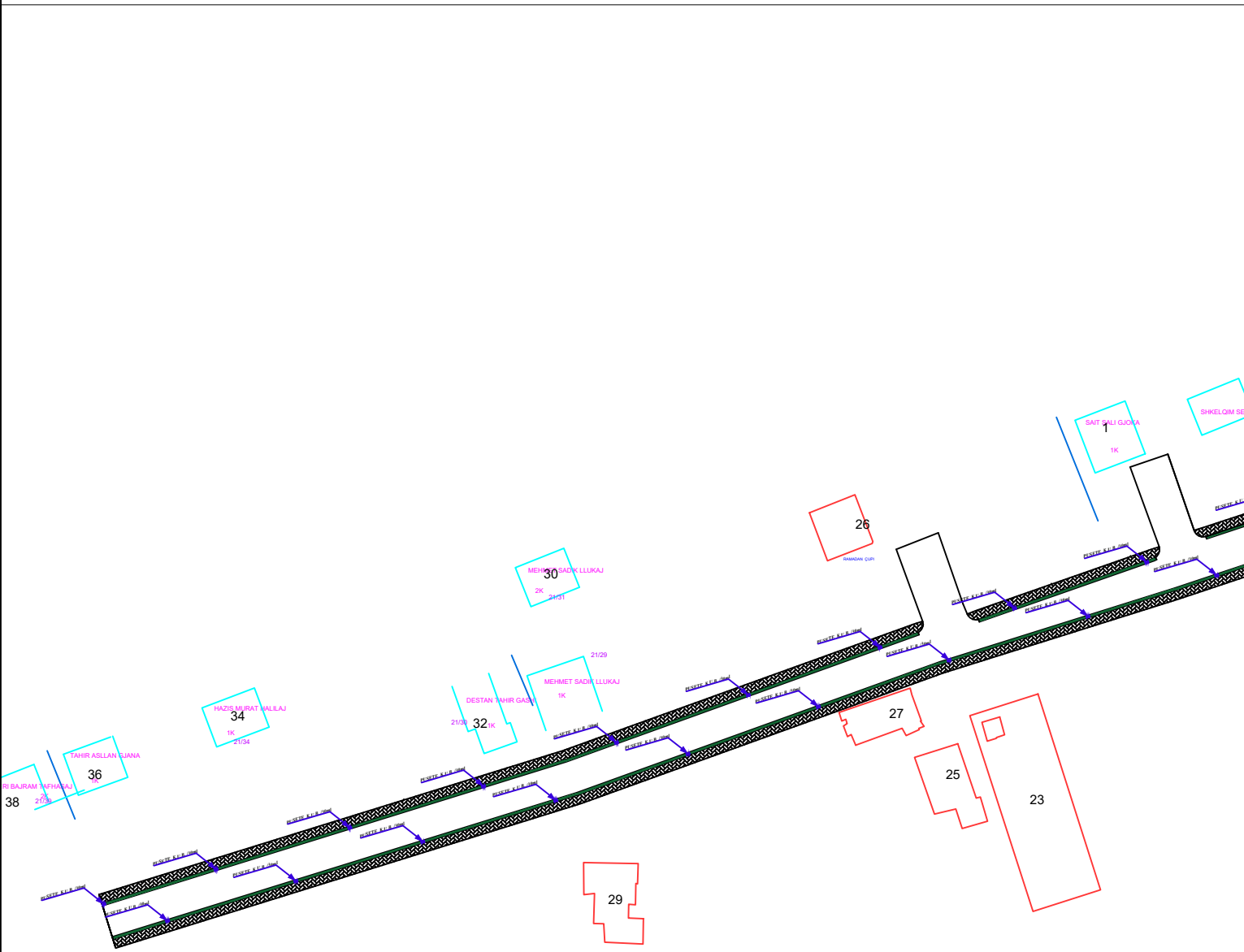

BASHKIA KAMEZ
 DREJTORIA E SHERBIMEVE PUBLIKE
 DREJTORIA E PROJEKTEVE DHE INVESTIMEVE
 DEPARTAMENTI I PROJEKTEVE

Dr. i Pergj. i Sherbimeve Publike ELVIS GJIKJA
 Dr. e Projekteve e Investimeve FLORA MUÇA

STAFI TEKNIK PROJEKTES	Ing. Konstruktor	EMANUELA MEZIU
	Ing. Gjeoinformatik	ERBLIN LALA
	Ing. Preventivues	HAJREDIN MURGU
	Ing. Topograf	RAMADAN HYSA

Titulli i Projektit
**NDERTIMI TROTUAR+NDRICIM+KUB
 RRUGA "JON+FUSHE ARREZ" Valias**

Faza e Projektit
PROJEKT ZBATIMI

Data e Implementimit :

Shkalla e Vizatimit

Emertimi i Fletes
 PLANIMETRI KUB

Fleta Nr.
A-17

DETAJE NDRICIMI

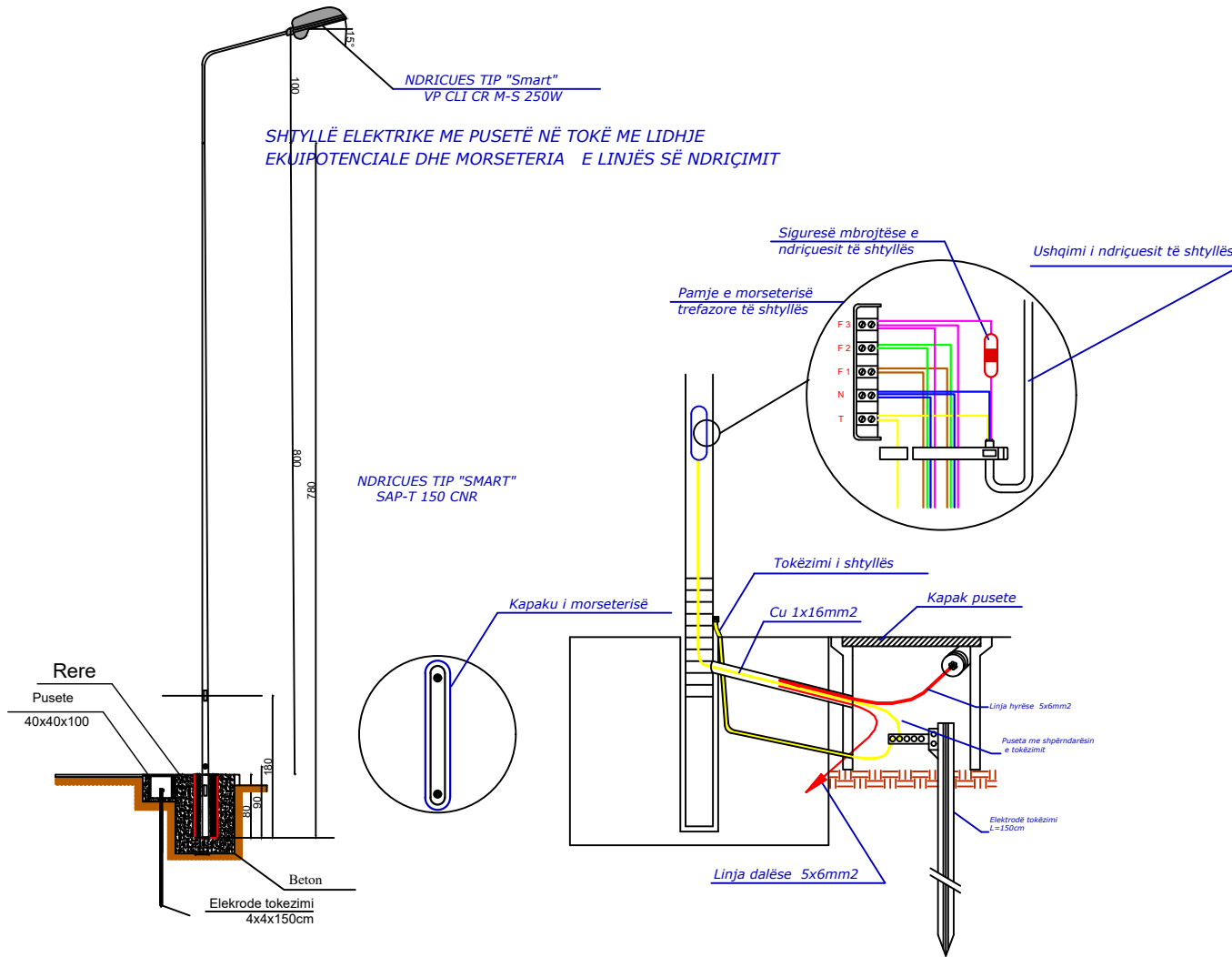

BASHKIA KAMEZ
DREJTORIA E SHERBIMEVE PUBLIKE
DREJTORIA E PROJEKTEVE DHE INVESTIMEVE
DEPARTAMENTI I PROJEKTEVE

Dr. i Pergj. i Sherbimeve Publike	ELVIS GJIKA
Dr. e Projekteve e Investimeve	FLORA MUÇA

STAFI TEKNIK PROJEKTUES	Ing. Konstruktor	EMANUELA MEZIU
	Ing. Gjeoinformatik	ERBLIN LALA
	Ing. Preventivues	HAJREDIN MURGU
	Ing. Topograf	RAMADAN HYSA

Titulli i Projektit NDERTIMI TROTUAR+NDRICIM+KUB RRUGA "JON+FUSHE ARREZ" Valias		Titulli i Projektit PROJEKT ZBATIMI
Emertimi i Fletes DETAJE NDRICIMI		Data e Implementimit :
Shkalla e Vizatimit		Fleta Nr.

Emertimi i Fletes DETAJE NDRICIMI		Fleta Nr. A-18
--------------------------------------	--	--------------------------

DETAJE NDRICIMI

Hollësi e inkastrimit të kolonës së ndriçuesit me lartësi H=9m

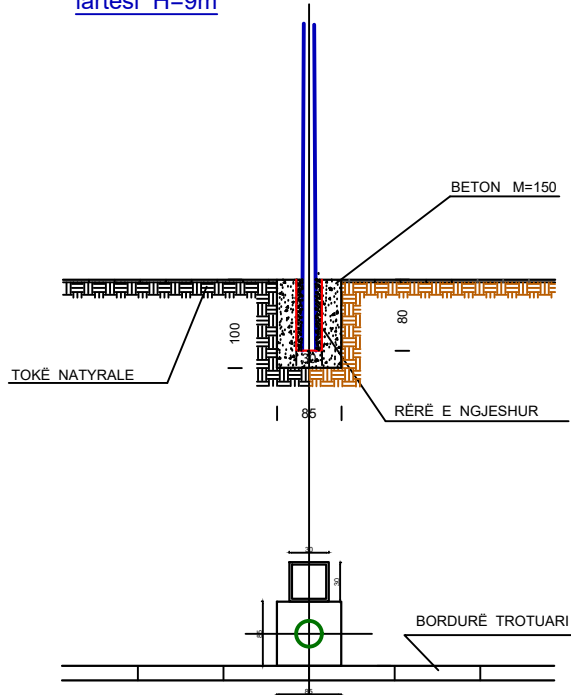

Hollësi e vendosjes së pusetës

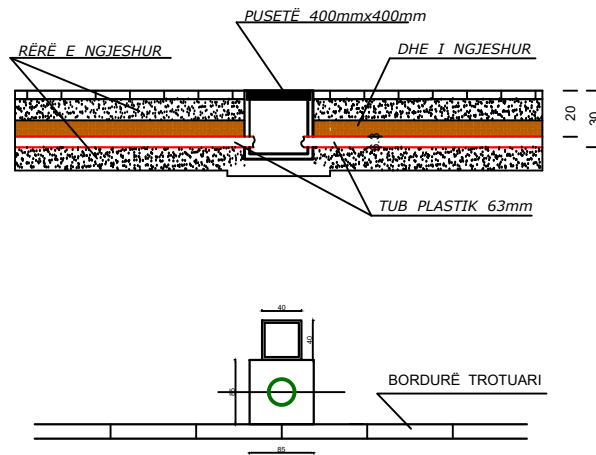

BASHKIA KAMEZ

DREJTORIA E SHERBIMEVE PUBLIKE
DREJTORIA E PROJEKTEVE DHE INVESTIMEVE
DEPARTAMENTI I PROJEKTEVE

Dr. i Pergj. i Sherbimeve Publike	ELVIS GJIKA
Dr. e Projekteve e Investimeve	FLORA MUÇA

STAFI TEKNIK	Ing. Konstruktor	EMANUELA MEZIU	
PROJEKTUES	Ing. Gjeoinformatik	ERBLIN LALA	
	Ing. Preventivues	HAJREDIN MURGU	
	Ing. Topograf	RAMADAN HYSA	

Titulli i Projektit	Faza e Projektit
NDERTIMI TROTUAR+NDRICIM+KUB RRUGA "JON+FUSHE ARREZ" Valias	PROJEKT ZBATIMI
Emertimi i Fletes	Data e Implementimit :
DETAJE NDRICIMI	Shkalla e Vizatimit
	Fleta Nr.
	A-19

DETAJE KUB

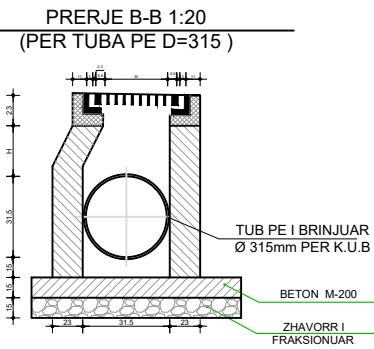
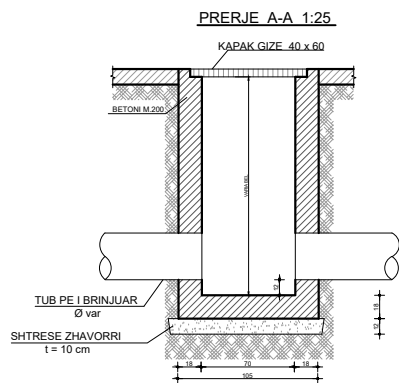
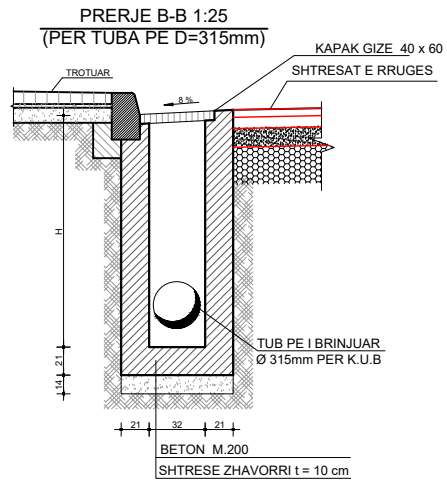
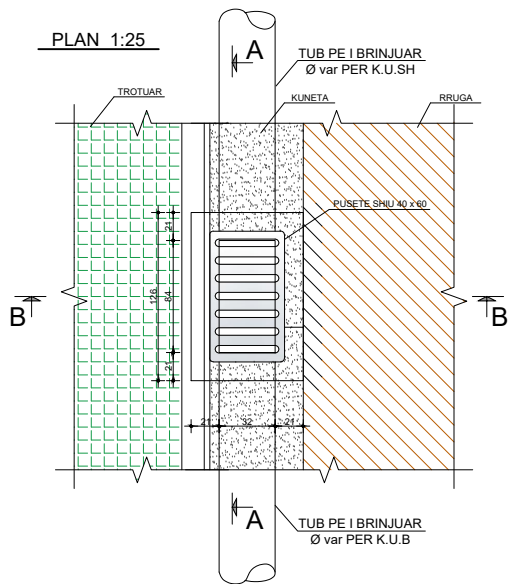

BASHKIA KAMEZ
DREJTORIA E SHERBIMEVE PUBLIKE
DREJTORIA E PROJEKTEVE DHE INVESTIMEVE
DEPARTAMENTI I PROJEKTEVE

Dr. i Pergj. i Sherbimeve Publike	ELVIS GJIKA
Dr. e Projekteve e Investimeve	FLORA MUÇA
STAFI TEKNIK PROJEKTES	Ing. Konstruktor EMANUELA MEZIU Ing. Gjeoinformatik ERBLIN LALA Ing. Preventivues HAJREDIN MURGU Ing. Topograf RAMADAN HYSA

Titulli i Projektit PROJEKT ZBATIMI	
Data e Implementimit :	
Shkalla e Vizatimit	
Emertimi i Fletes	
DETAJE KUB	
Fleta Nr. A-20	