

BASHKIA DURRES



BASHKIA DURRES

OBJEKTI:

**REHABILITIM "RRUGA E DESHMOREVE", NGA KRYQEZIMI ME
RRUGEN "MUJO ULQINAKU" TEK STACIONI I TRENIT**



DURRES, 2023

NJESIA E PROEJKTIT DHE INFRASTRUKTURES

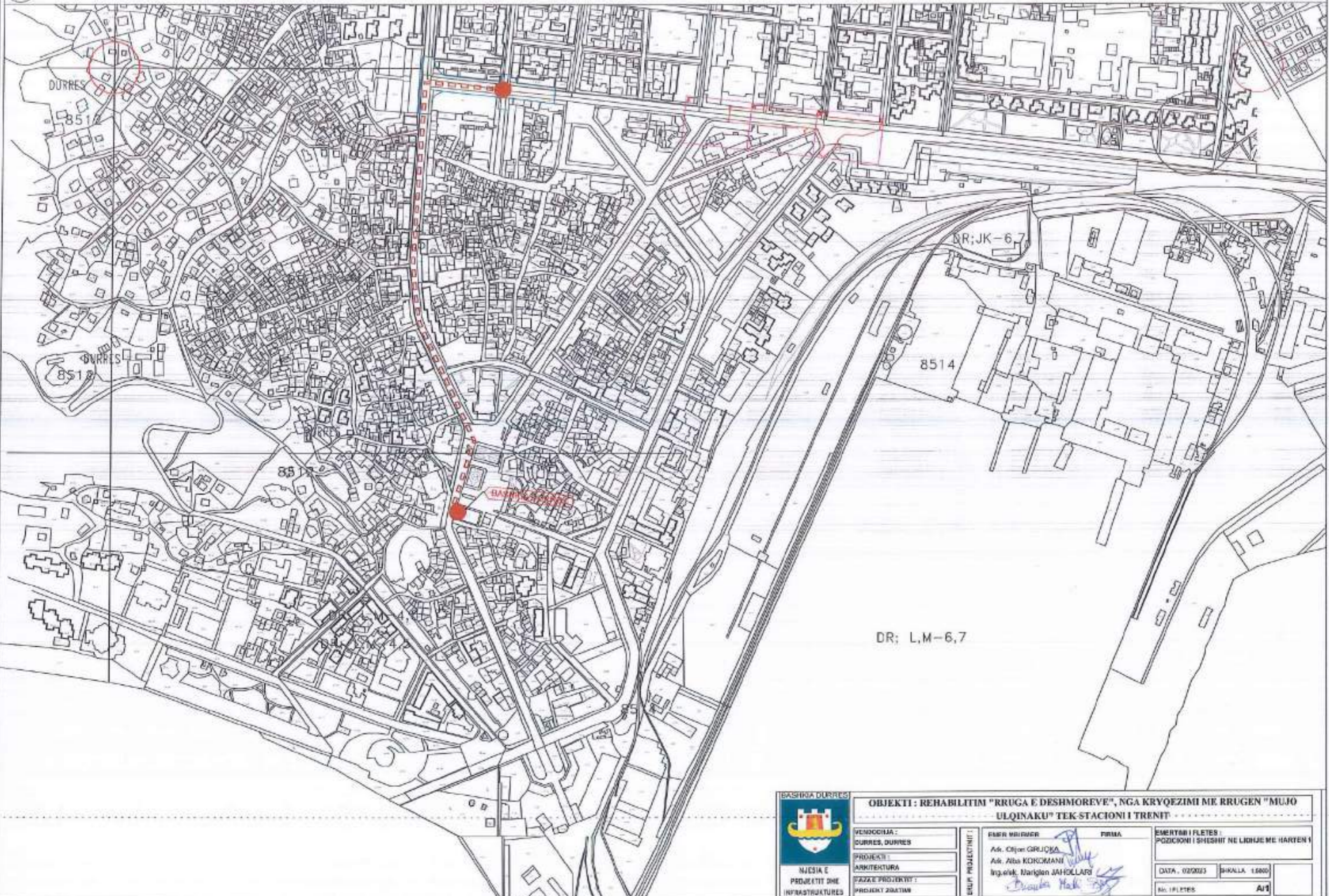

OBJEKTI: REHABILITIM "RRUGA E DESHMOREVE", NGA KRYQEZIMI ME RRUGEN "MUJO ULQINAKU" TEK STACIONI I TRENIT

VENOCILIA:
DURRES, DURRES
PROJEKTI:
ARKITEKTURA
FAZA E PROJEKTYT:
PROJEKT ZBATIM

EMER MIRMIRI
Adi, Çiljan GRUÇKA
Adi, Alta KOKOMANI
Inj. enj. Nartigan JAHOLLARI
Dr. M. Haki

EMERTIM I FLETES
POZICIONI I SHESHIT NE LIDHJE ME HARTEN 1
DATA: 02/2023 SHKALLA: 1:5000
No. FLETES: A/1

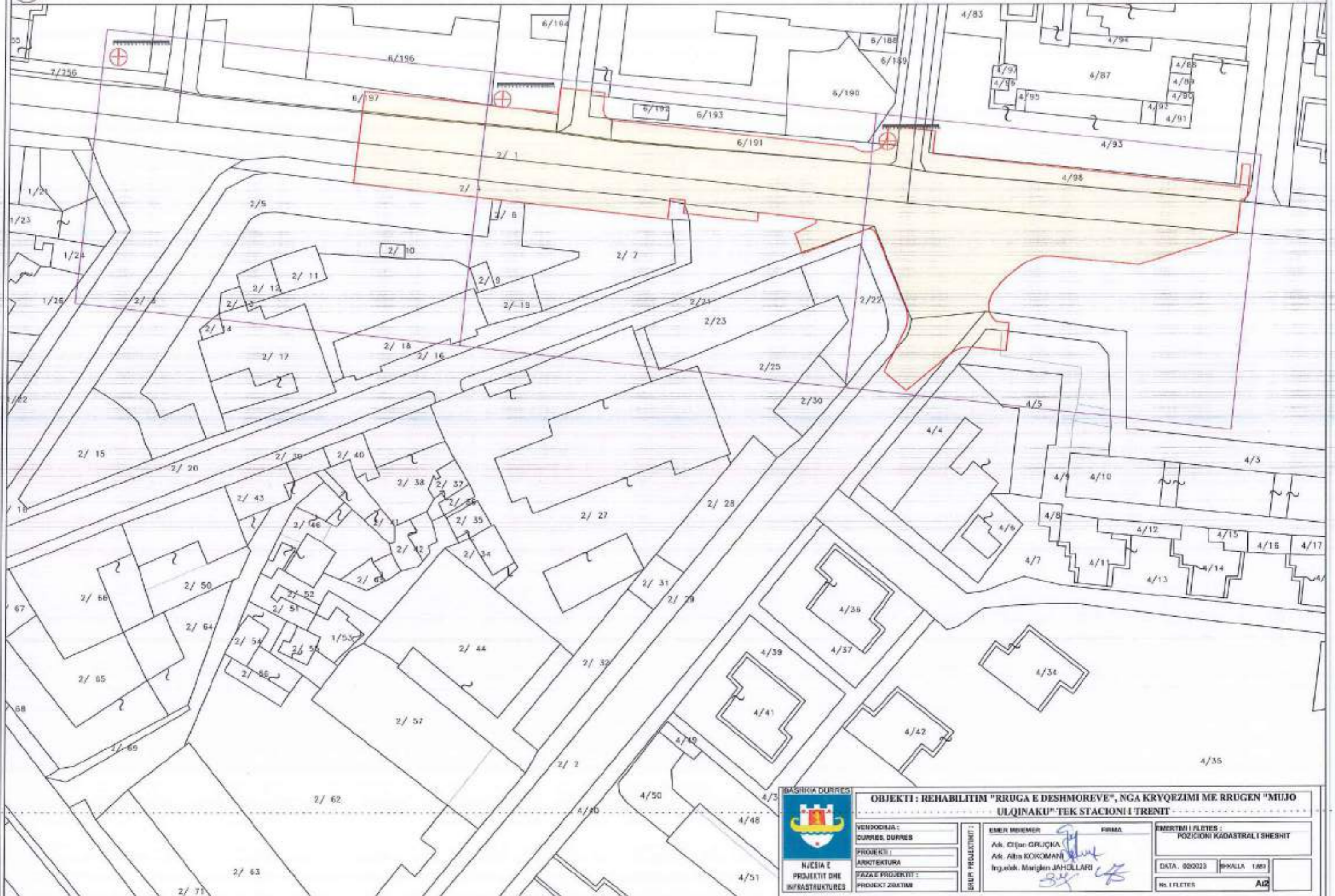

 <p>BASHKIA E DURRËS</p> <p>NJESIA E PROJEKTIT DHE INFRASTRUKTURES</p>	<p>OBJEKTI: REHABILITIM "RRUGA E DESHMOREVE", NGA KRYQEZIMI ME RRUGEN "MUJO ULQINAKU" TEK STACIONI I TRENT</p>			
	<p>VENDOSJA:</p> <p>DURRES, DURRES</p>	<p>EMER MBEMER</p> <p>Ak. CILAN GRUJKA</p>	<p>FIRMA</p> <p><i>[Signature]</i></p>	<p>EMERTIMI I FLETES:</p> <p>POZICIONI KADASTRALI SHESHIT</p>
	<p>PROJEKTI:</p> <p>ARHITEKTURA</p>	<p>GRUP PROJEKTIMIT:</p> <p>Ing. Ak. ALTA KOKOMANI</p> <p>Ing. Ak. MARGJEN JAHOLLARI</p> <p><i>[Signatures]</i></p>	<p>DATA: 08/2023</p> <p>SKALLA: 1:850</p>	<p>No. I FLETES:</p> <p>A12</p>
	<p>FAZA E PROJEKTIT:</p> <p>PROJEKT ZBATIM</p>			



 BASHKIA DURRES NJESIA E PROJEKTI DHE INFRASTRUKTURES	OBJEKTI : REHABILITIM "RRUGA E DESHMOREVE", NGA KRYQEZIMI ME RRUGEN "MUJO ULQINAKU" TEK STACIONI I TRENIT			
	VENDOSHA : DURRES, DURRES	EMER MINEMER Ark. Olgos GRUÇKA Ark. Alta KOROMANI Ing. shk. Mariglen JAHOLLARI	FIRMA 	ENERTIMI FLETES : FOTO GJENJOJA EIGZISTUESE
	PROJEKTI : ARKITEKTURA	BILUP PROJEKTIMI : 	DATA : 02/2022	SHALLA :
	FAZA E PROJEKTI : PROJEKT ZBATIM	No. I FLETES :	A/3	



DZISIONI I SHESHIT SIPAS ORTOFOTOS

		OBJEKTI : REHABILITIM "RRUGA E DESHMOREVE", NGA KRYQEZIMI ME RRUGEN "MUJO ULQINAKU" TEK STACIONI I TRENTI	
VENEDHJA : DURRES, DURRES	EMER NDIEMER : Ark. Orljon GRUÇKA Ark. Aida KOKOMAN Ing.olek. Nergjan JAHOLLARI	FIRMA : 	EMERTSI I FLETES : POZICIONI I SHESHIT SIPAS ORTOFOTOS
PROJEKTI : ARKITEKTURA	GRUPI PROJEKTIMIT :	DATA : 02/2023	SHKALLA : 1:500
FAZA E PROJEKTI : PROJEKT ZBATIMI	No. I FLETES :	No. I FLETES :	A/4
NJESIA E PROJEKTI DHE INFRASTRUKTURES			

Piketa-04
370.489,42
4.575.261,57

Piketa-03
370.495,49
4.575.240,82

370.495,49
4.575.205,53

(BASHKRIA DURRES)



MJESIA E
PROJEKTIT DHE
INFRASTRUKTURES

**OBJEKTI : REHABILITIM "RRUGA E DESHMOREVE", NGA KRYQEZIMI ME RRUGEN "MUJO
ULQINAKU" TEK STACIONI I TRENT**

VENDOHJA :
DURRES, DURRES
PROJEKTI :
ARKITEKTURA
FAZAE PROJEKTIT :
PROJEKT ZBATIMI

EMER MBEEMER
Ark. Olfjon GRUÇKA
Ark. Alba KOKÇMANI
Ing.ekol. Maripon JAHOLLARI
FIRMA
[Signature]
GRUP PROJEKTIMIT I

EMERTIMI I FLETES :
POZICIONI I SHESHIT SIPAS ORTOFOTOS
PIKETA 01- PIKETA 04
DATA : 02/2023 SHKOLLA : 1:250
No. FLETES : A/5

B-07
26
04,48

Piketa-06
370.402,88
4.575.261,13

Piketa-05
370.455,60
4.575.255,60

Piketa-03



OBJEKTI : REHABILITIM "RRUGA E DESHMOREVE", NGA KRYQEZIMI ME RRUGEN "MUJO ULQINAKU" TEK STACIONI I TRENIT

VENDDORJA :
DURRES, DURRES
PROJEKTI :
ARCHITECTURA
FAZEA E PROJEKTE :
PROJEKT ZBATIMI

ENER VISIMER
Ark. Olgja GRUÇKA
Ark. Albi KOKOMANI
Ing. Nisik. Marigjon JAHOLLARI

EMERTIMI I FLETES :
POZICIONI I SHESHIT SIPAS ORTOFOTOS
PIKETA 03- PIKETA 06
DATA : 02/2023 | SHKALLA : 1:250
No. I FLETES : A/E

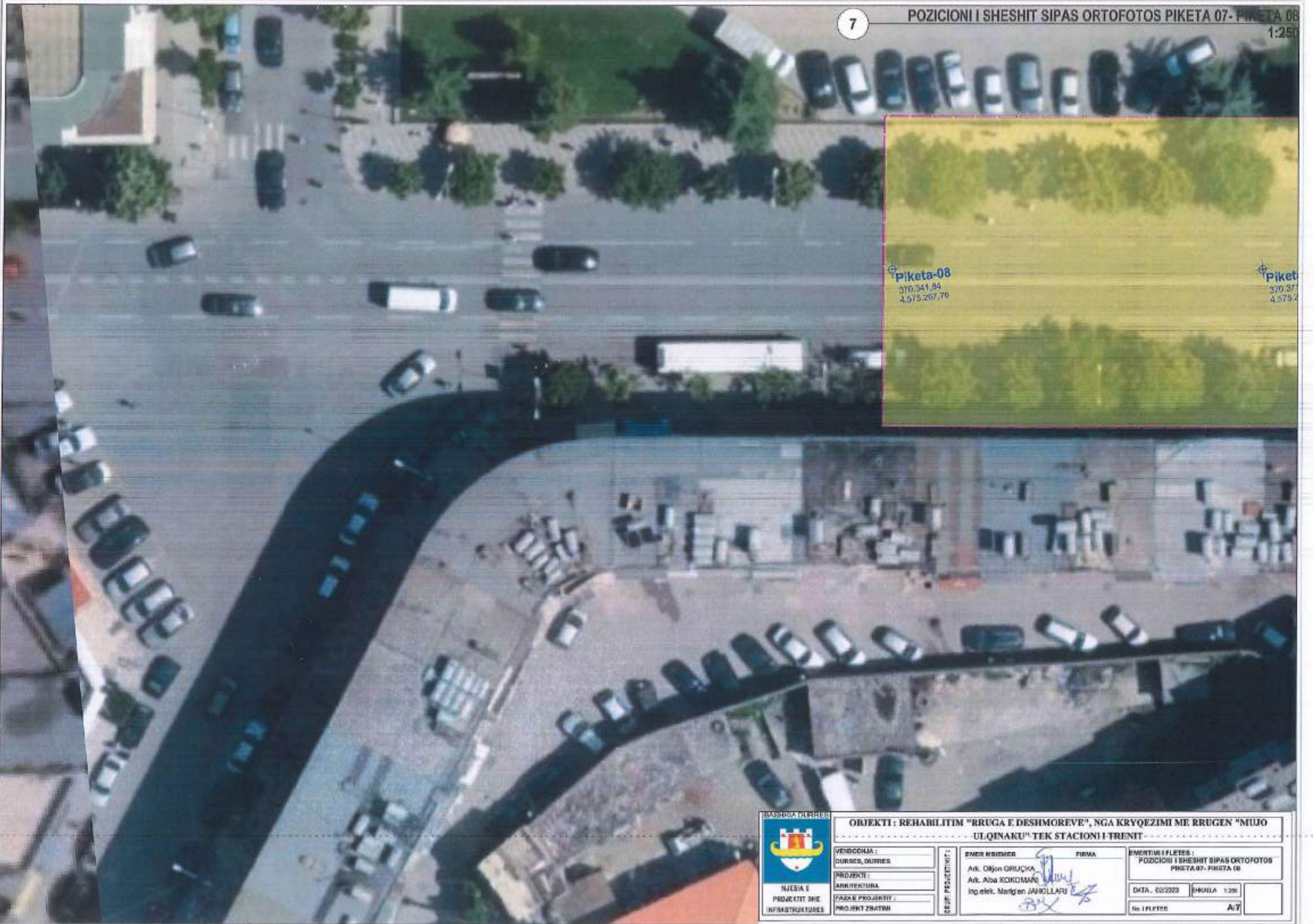

Piketa-08
370,341,84
4,575,207,70

Piketa-07
370,371,84
4,575,207,70



OBJEKTI : REHABILITIM "RRUGA E DESHMOREVE", NGA KRYQEZIMI ME RRUGEN "MUJO ULQINAKU" TEK STACIONI I TRENIT			
VENDOSJA : DURRES, DURRES		EMER NRIEMER Ark. Orljon GRUÇKA	
PROJEKTI : ARRIFRUTURA		FIRMA <i>[Signature]</i>	
FAKSA E PROJEKTI : PROJEKT ZBATIM		Ing.elek. Nardjan JAVOLLARI	
		EMERTIVE I FLETES : POZICIONI I SHESHIT SIPAS ORTOFOTOS PIKETA 07- PIKETA 08	
		DATA : 02/2023 SHKALLA : 1:250	
		No. I FLETES : A/7	

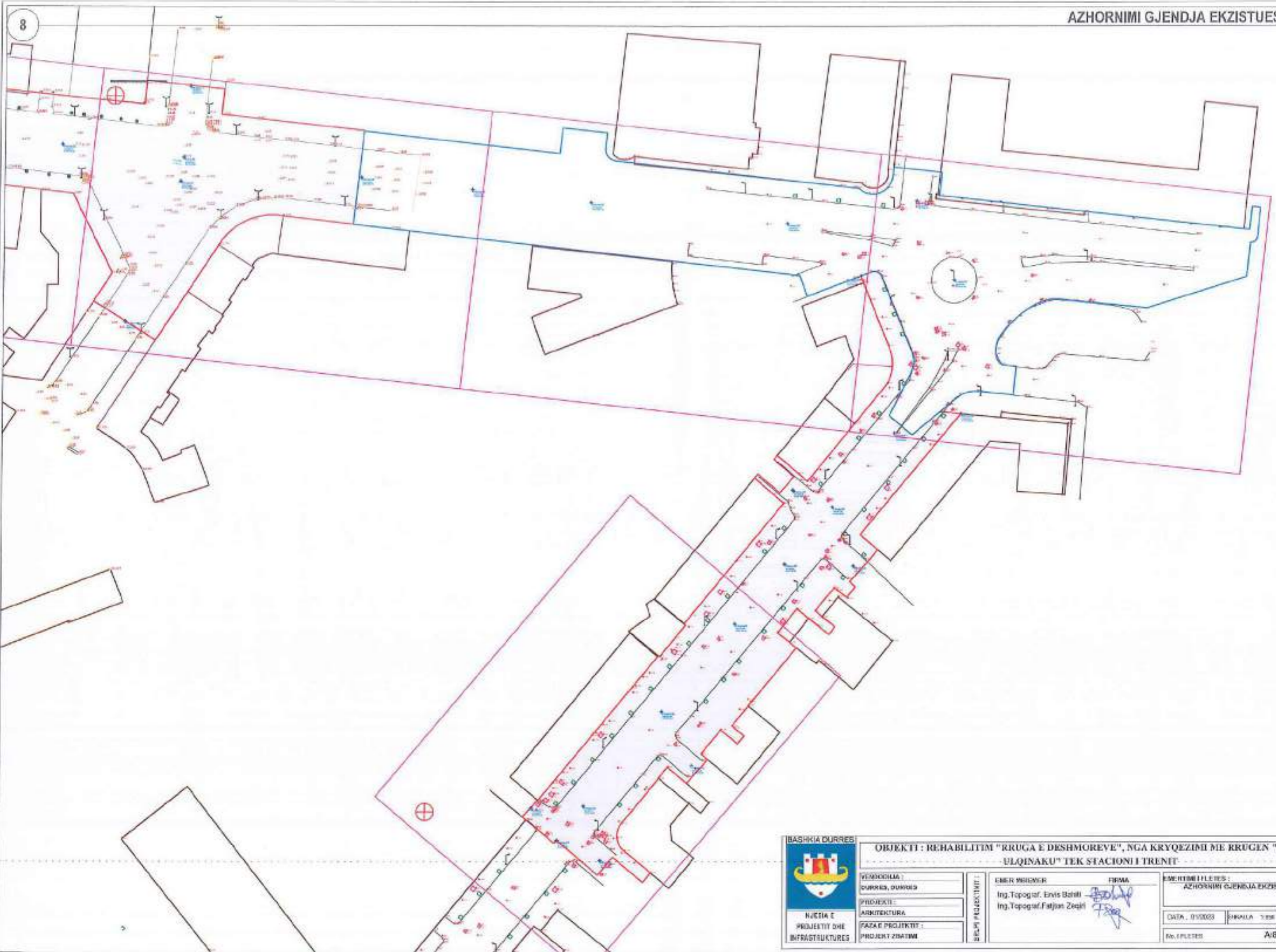

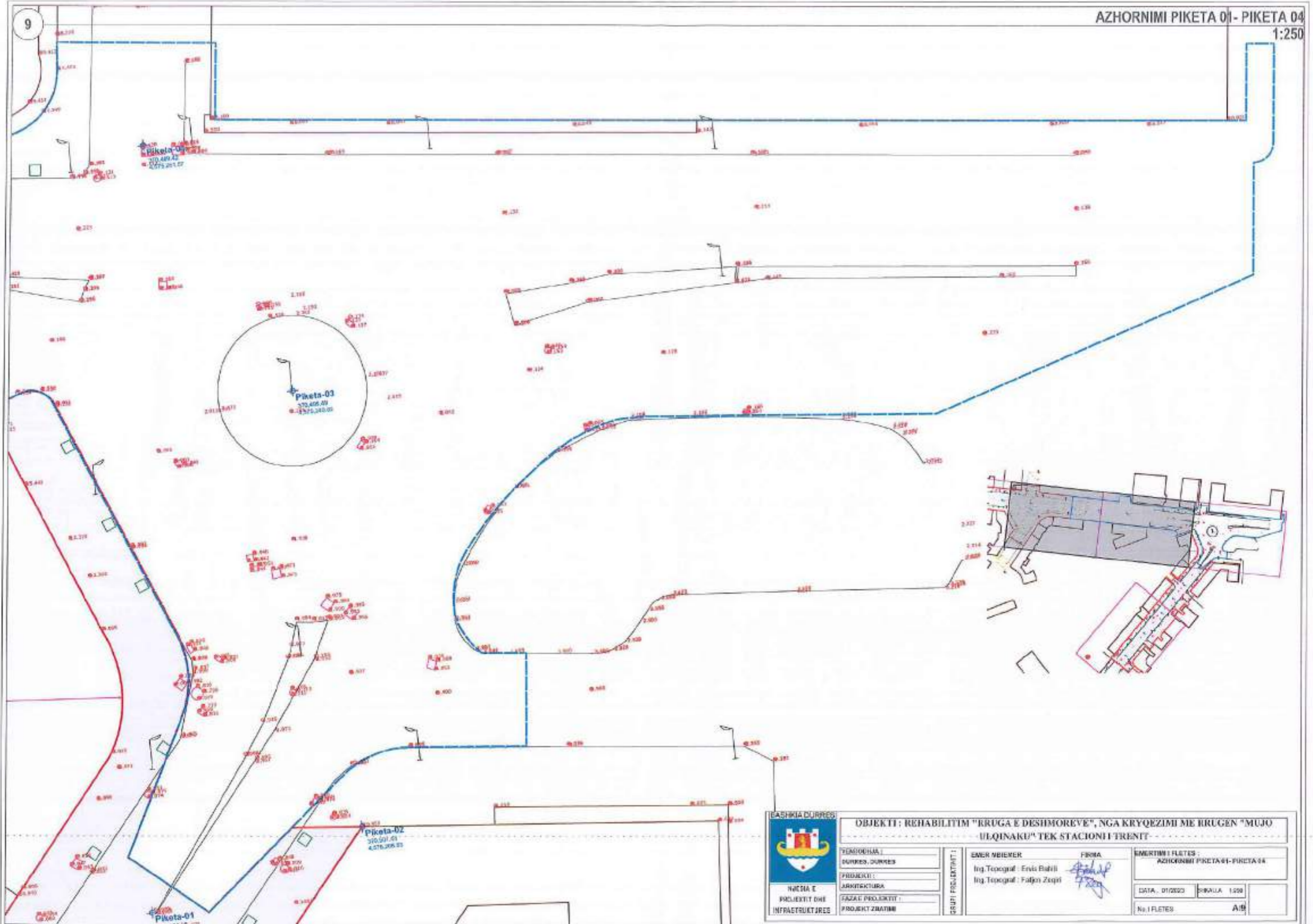

 BASHKIA DURRËS NJËSIA E PROJEKTIT DHE INFRASTRUKTURËS	OBJEKTI : REHABILITIM "RRUGA E DESHMOREVE", NGA KRYQEZIMI ME RRUGEN "MUJO ULQINAKU" TEK STACIONI I TRENIT		EMËRTIMI I FLETËS : AZHORNIMI GJENDJA EKZISTUESE	
	VENDORIJA : DURRËS, DURRËS PROJEKTI : ARKITEKTURA FAZA E PROJEKTIT : PROJEKT ZBATIMI	EMËRI MËSHTOER Ing. Topograf. Ervis Beletli Ing. Topograf. Fatjon Zeqiri	FIRMA 	DATA : 01/0023 SHIFRA : 1/08 No. FLETËS : A/B

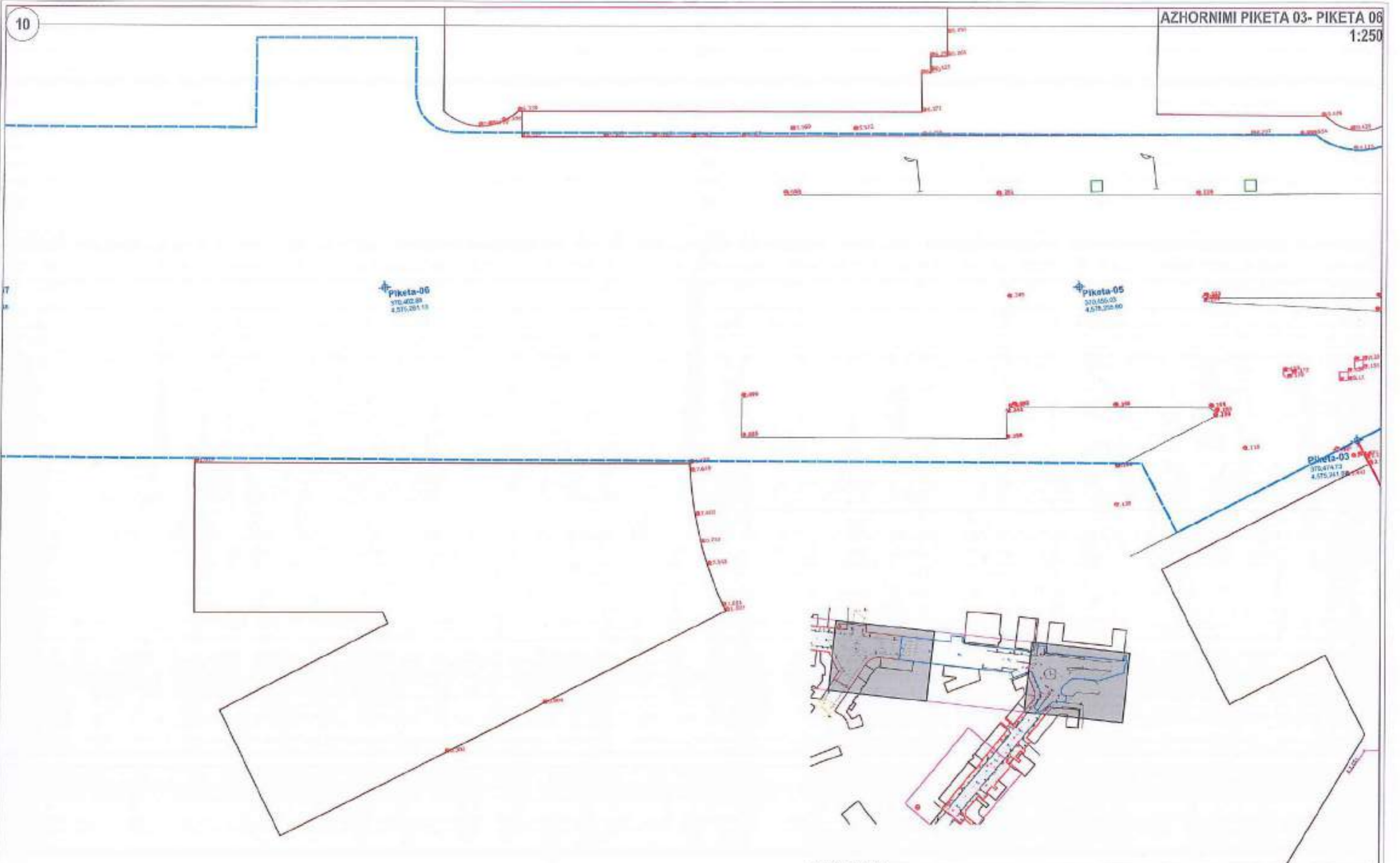

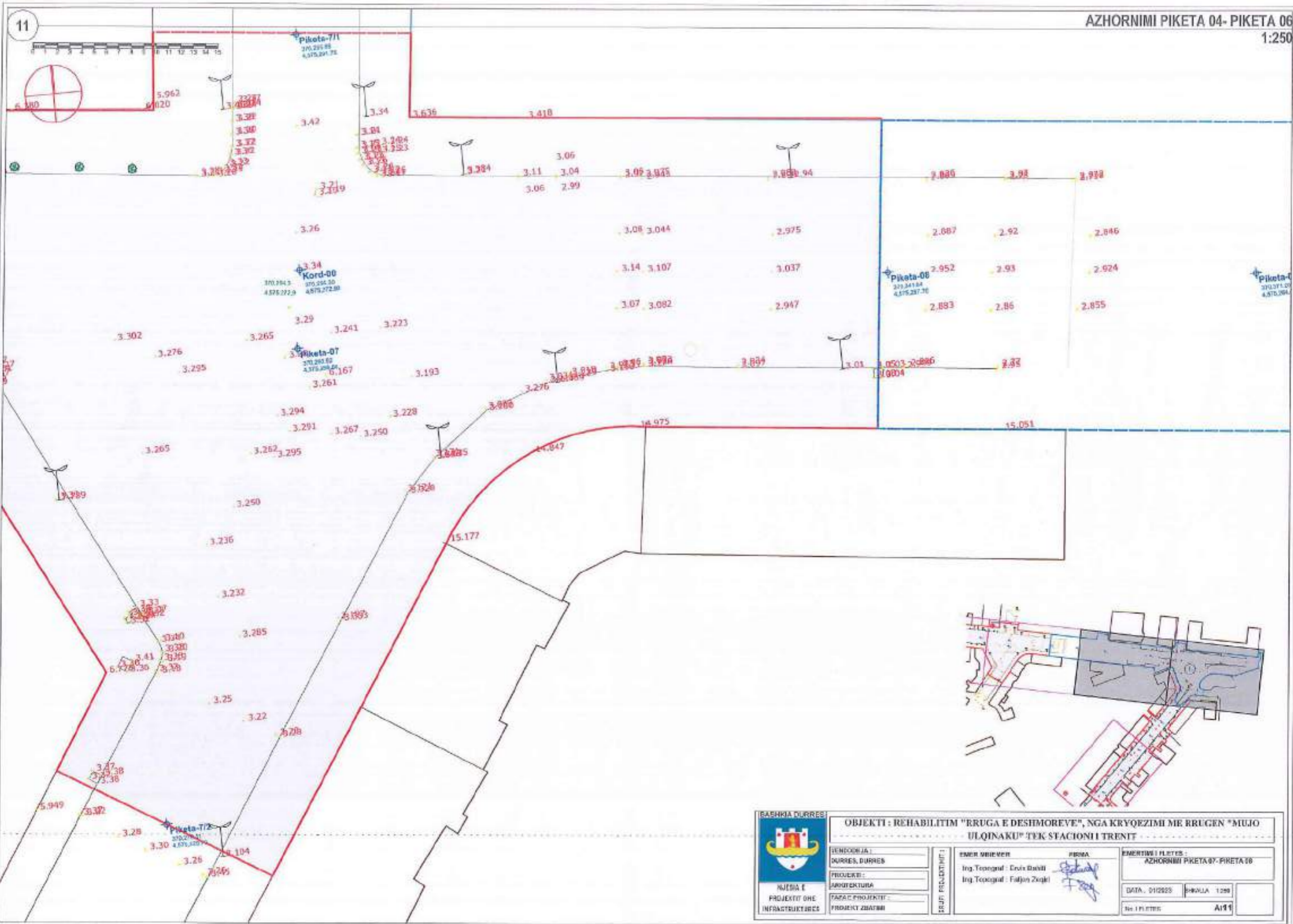

 BASHKIA DURRËS NJESIA E PROJEKTIT DHE INFRASTRUKTURËS	OBJEKTI : REHABILITIM "RRUGA E DESHIMOREYE", NGA KRYQEZIMI ME RRUGEN "MUJO ULQINAKU" TEK STACIONI I TRENIT			
	VEHICORUA : DURRES, DURRES	GRUPI PROJEKTIMIT : ENER AMBIEMER Ing. Enisë Bafili Ing. Fajon Zeqiri	PRISHA : 	EMERTIMI I FLETES : AZHORNIMI PIKETA 03- PIKETA 06
	PROJEKTI : ARKITEKTURA		DATA, DITËSET : SHALLA : 1250	No. I FLETES : A110
	FAZAT E PROJEKTIT : PROJEKT ZBATIMI			



 REPUBLIKA E ALBANIJE NJESIA E PROJEKTIT DHE INFRASTRUKTURES	OBJEKTI : REHABILITIM "RRUGA E DESHMOREVE", NGA KRYQEZIMI ME RRUGEN "MUJO ULQINAKU" TEK STACIONI I TRENT		
	BENEKORJA : DURRES, DURRES	EMER MBIEVET Ing. Topograf : Crvis Daxiti Ing. Topograf : Faljan Zeqiri	EMERTIMI FLETES : AZHORNIMI PIKETA 07- PIKETA 18
	PROJEKTI : ARKITEKTURA		DATA : 01/2023 SHKILLA : 1/200
	PARAC PROJEKTI : PROJEKT ZBATIMI	SHIFR. PROJEKTI :	No. I FLETES : A/11

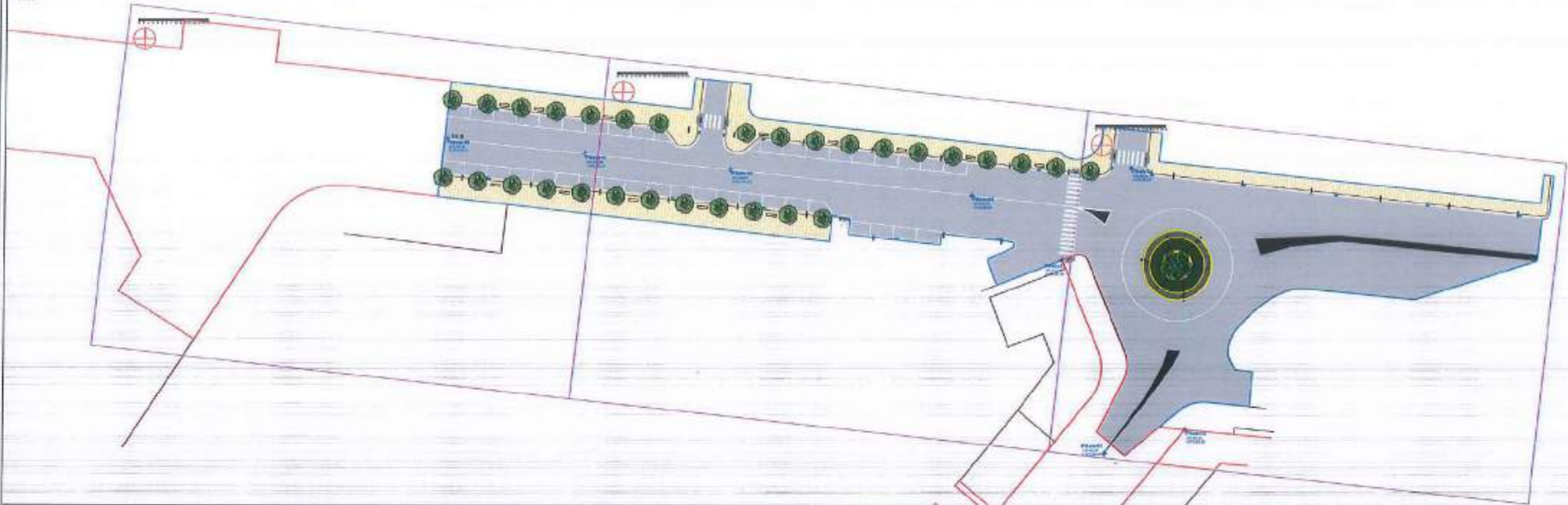

Kordinatat e Piketave (UTM ZONE 34N)

Nr.Objekti	Piketa	Coordinate X	Coordinate Y
------------	--------	--------------	--------------

KORDINATA

	Piketa-01	370,483.95	4,575,200.43
	Piketa-02	370,501.44	4,575,205.53
	Piketa-03	370,474.73	4,575,241.88
	Piketa-03	370,499.49	4,575,240.82
	Piketa-04	370,489.42	4,575,261.57
	Piketa-05	370,455.03	4,575,255.60
	Piketa-06	370,402.88	4,575,261.13
	Piketa-07	370,371.28	4,575,264.48
	Piketa-08	370.341,64	4.575.267,70

 NJESIA E PROJEKTI DHE INFRASTRUKTURES	OBJEKTI : REHABILITIM "RRUGA E DESHMOREVE", NGA KRYQEZIMI ME RRUGEN "MUJO ULQINAKU" TEK STACIONI I TRENIT			
	VENDORIJA : DURRES, DURRES	EMER MBIDMOR Ark. Otjon GRUÇKA Ark. Arta KOKOMANI Inj.elek. Mariglen JAHOLLARI	FIRMA 	EMERTIMI I FLETES : PLAN PIKETIMI
	PROJEKTI : ARHITEKTURA	GRUPI PRESENTIMET :	DATA : 02/2023	SHALLJA : 1:850
	FAZA E PROJEKTI : PROJEKT ZBATIM	NO. I FLETES :	A/12	

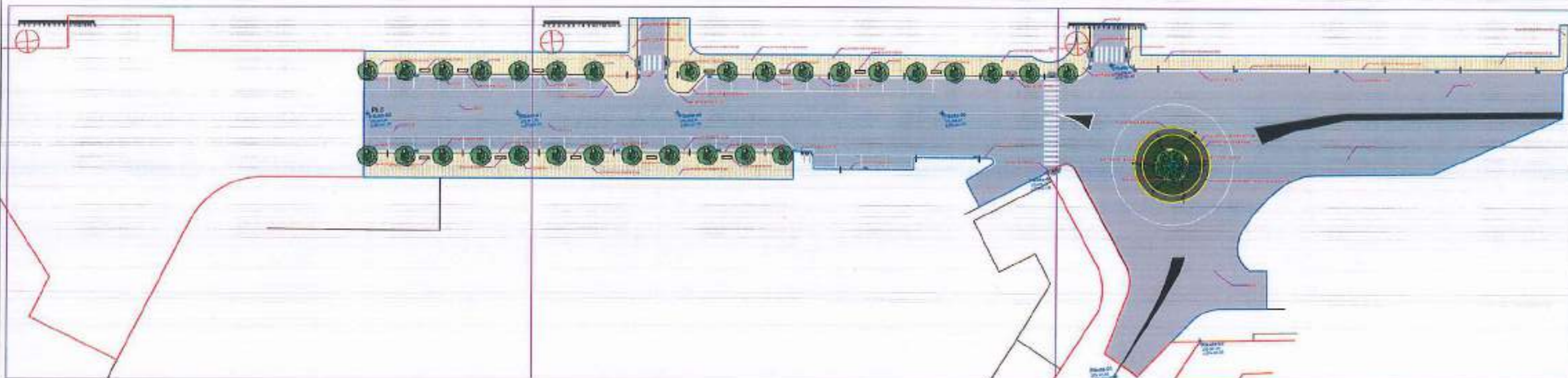

 BASHKIA DURRËS NJESIA E PROJEKTIT DHE INFRASTRUKTURËS	OBJEKTI: REHABILITIM "RRUGA E DESHMOREVE", NGA KRYQEZIMI ME RRUGEN "MUJO ULQINAKU" TEK STACIONI I TRENIT		EMERTIMI I FLETES: PLANVENDOSJE PERGJITHESHME	
	VERODHJA: DURRËS, DURRËS PROJEKTI: ARKITEKTURA FAZAE PROJEKTIT: PROJEKT ZBATIM	EMER AMEMER Ark. Ojton GRUÇKA Ark. Alta KOKOMARI Ing.olek. Mariglen JAROLLARI	FIRMA   	DATA: 02/2023 No. I FLETES:

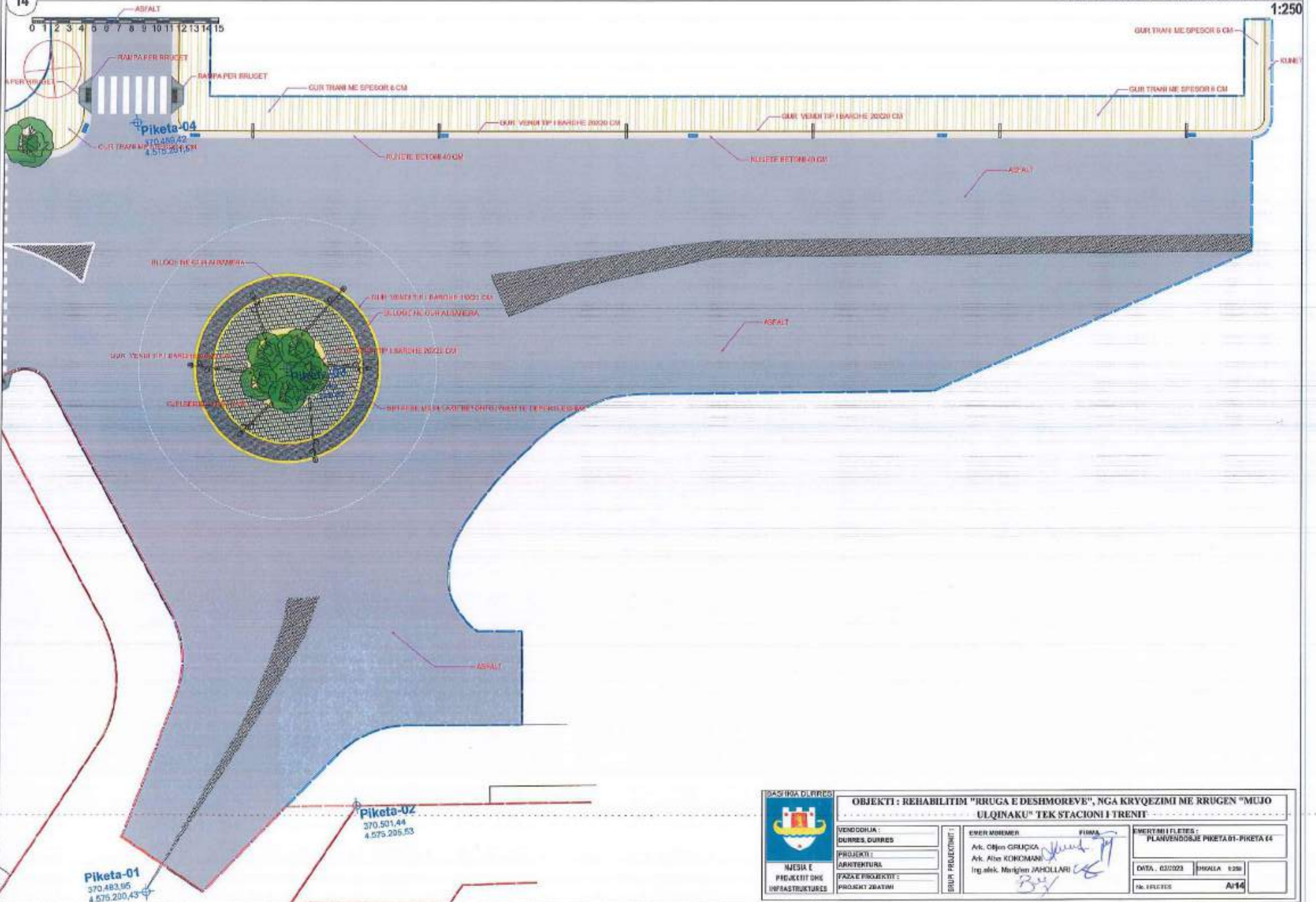

<p>DASHI I BA DËRRËS</p> <p>INJENIERIA E PROJEKTIT DHE INFRASTRUKTURËS</p>	<p>OBJEKTI : REHABILITIM "RRUGA E DESHMOREVE", NGA KRYQEZIMI ME RRUGEN "MUJO ULQINAKU" TEK STACIONI I TRENIT</p>		<p>EMERTIMI I FLETËS : PLANVENDOSJE PIKETA 01-PIKETA 04</p>	
	<p>VENDOSHA : DURRES, DURRES</p>	<p>EMER MEMER</p> <p>Ark. Orljon GRUÇKA</p> <p>Ark. Arian KORÇMANI</p> <p>Ingj. shik. Markim JAHOLLARI</p>	<p>FILIPA</p>	<p>DATA : 02/2023</p> <p>SHALLA : 028</p> <p>Nr. I FLETËS : A/14</p>
	<p>PROJEKTI : ARHITEKTURA</p>	<p>GRUP PROJEKTIMIT :</p>	<p>FAZË E PROJEKTIT : PROJEKTI ZBATIMI</p>	

0 1 2 3 4 5 6 7 8 9 10 11 12 13 14 15

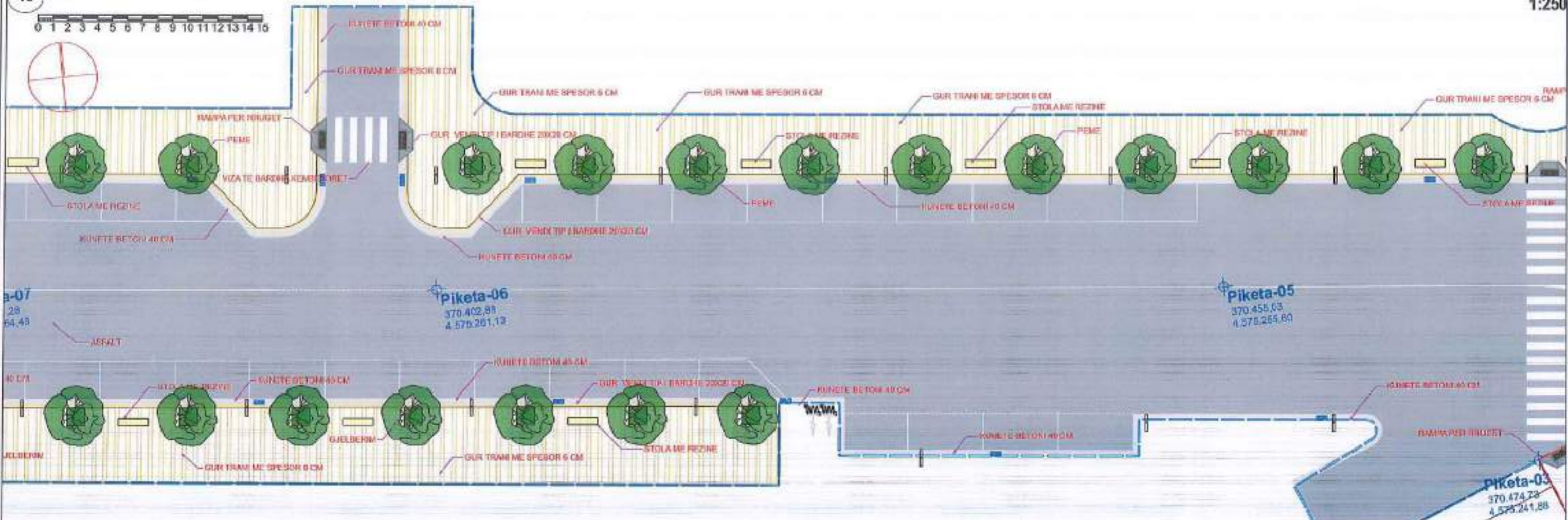

3-07
28
54.43

40.071

GJELBERIM

<p>SHKURIA DURES</p> <p>NJESIA E PROJEKTIT DHE INFRASTRUKTURES</p>	OBJEKTI : REHABILITIM "RRUGA E DESHMOREVE", NGA KRYQEZIMI ME RRUGEN "MUJO ULQINAKU" TEK STACIONI I TRENIT		EMERTIMI I FLETES : PLANVENDOSJE PIKETA 03-PIKETA 06		
	VENDONJARI : DURES, DURES	EMBR. MBRIMAR : Ark. Ojton GRUÇKA	FIRMA : Ark. Alba KOKOMANI Ing. Elek. Marjlen JAHOLLARI	DATA : 02/2023	SHKALLA : 1:250
	PROJEKTI : ARKITEKTURA	GRUPI PROJEKTIMIT :		No. FLETES :	A/15
	PAKU PROJEKTIT : PROJEKT ZBATIMI				

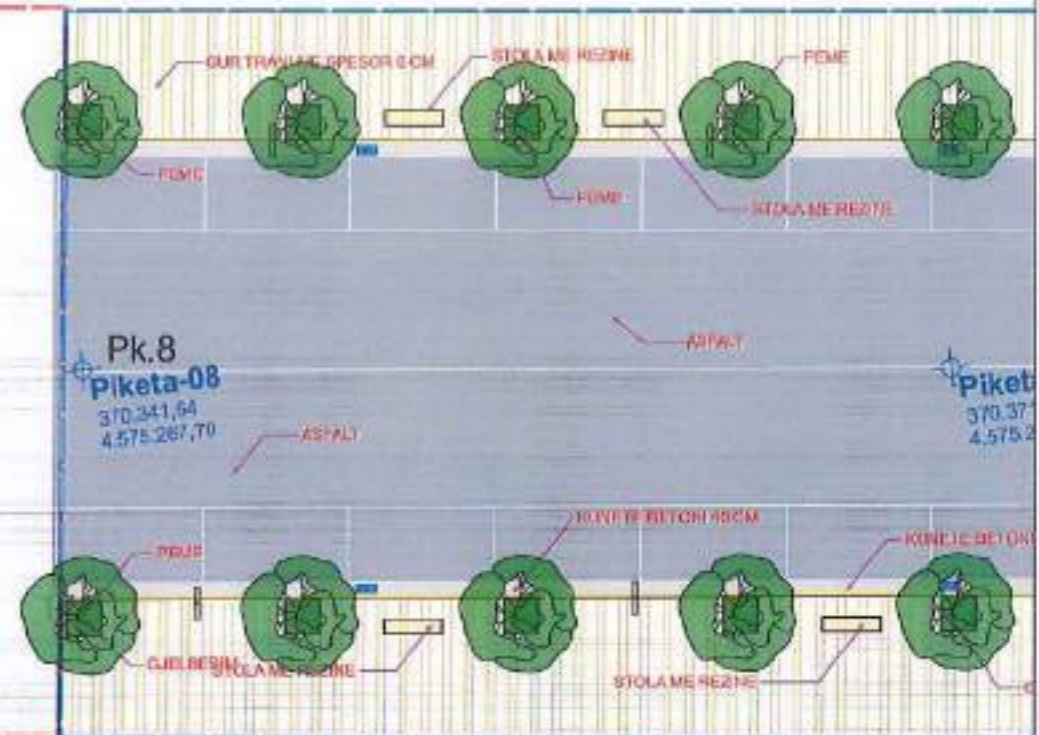

<p>BASHKIA E DURRËS</p> <p>NJESIA E PROJEKTIT DHE INFRASTRUKTURES</p>	<p>OBJEKTI: REHABILITIM "RRUGA E DESHMOREVE", NGA KRYQEZIMI ME RRUGEN "MUJO ULQINAKU" TEK STACIONI I TRENIT</p>		<p>EMERTIMI I FLETES: PLANVENDOSJE PIKETA 07- PIKETA 08</p>		
	<p>VENDOSHAS: DURRES, DURRES</p>	<p>EMER MBEMER: Ark. Orljon GRUÇKA</p>	<p>PRIMA: Ark. Alba KOKOMANI</p>	<p>DATA: 02/2023</p>	<p>SHALLA: 1/250</p>
	<p>PROJEKTI: ARKITEKTURA</p>	<p>GRUP PROJEKTIMIT: Ark. Merigen JAHOLLARI</p>		<p>HL. E FLETES:</p>	<p>A/16</p>
	<p>FAZJA E PROJEKTIT: PROJEKTI ZBATIM</p>				

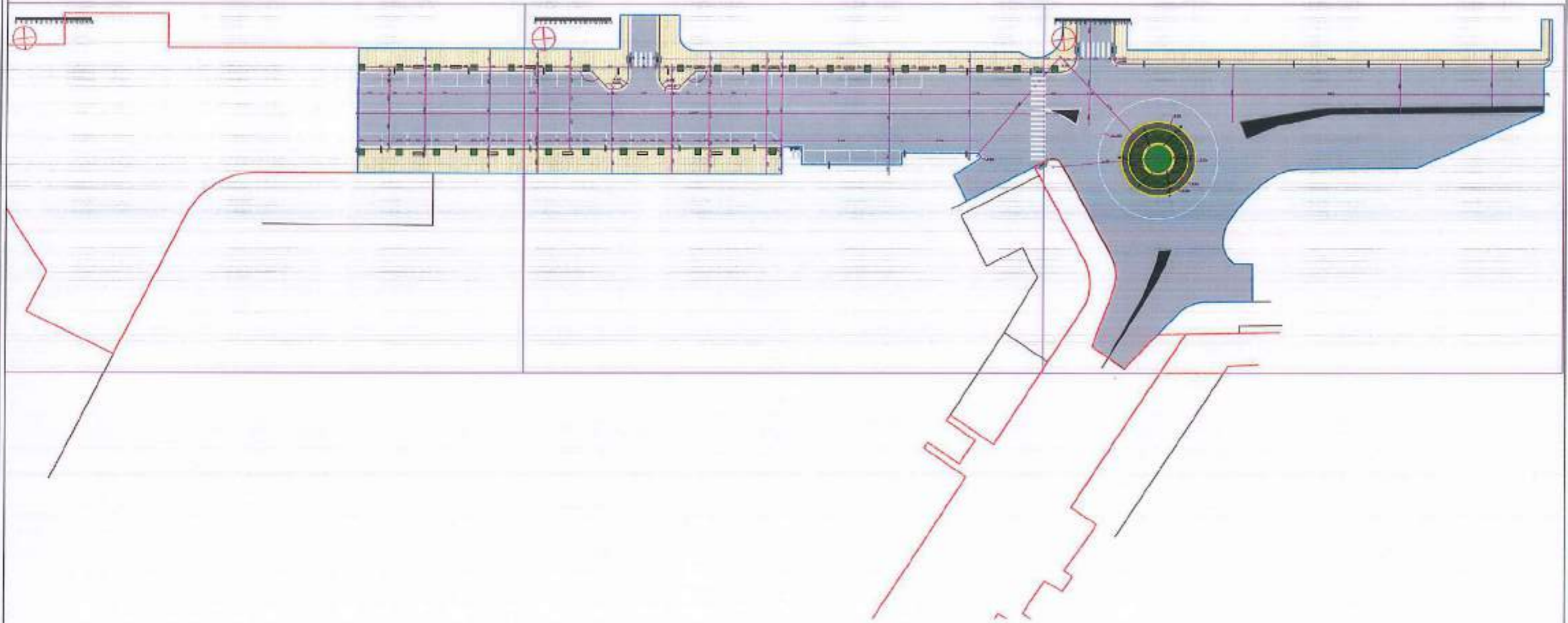

 NJËSIA E PROJEKTI DHE INFRASTRUKTURA	OBJEKTI : REHABILITIM "RRUGA E DESHMOREVE", NGA KRYQEZIMI ME RRUGEN "MUJO ULQINAKU" TEK STACIONI I TRENIT		EMERTIMI I FLETES : PLANVENDOSJE ME DISTANCAT PERKATESE MBI GJENDJEN EKZISTUESE	
	VENDORIA : DURRES, DURRES PROJEKTI : ARHITEKTURA FAZA E PROJEKTI : PROJEKT ZBATIM	GRUPI PROJEKTI: EVER NDICER Ark. Orljon GRUÇKA Ark. Ato KOKOMANI Ing. elok. Marigjon JAHOLLARI	FIRMA 	DATA : 02/2023 SHKILLA : 1:750 No. I FLETES : A117

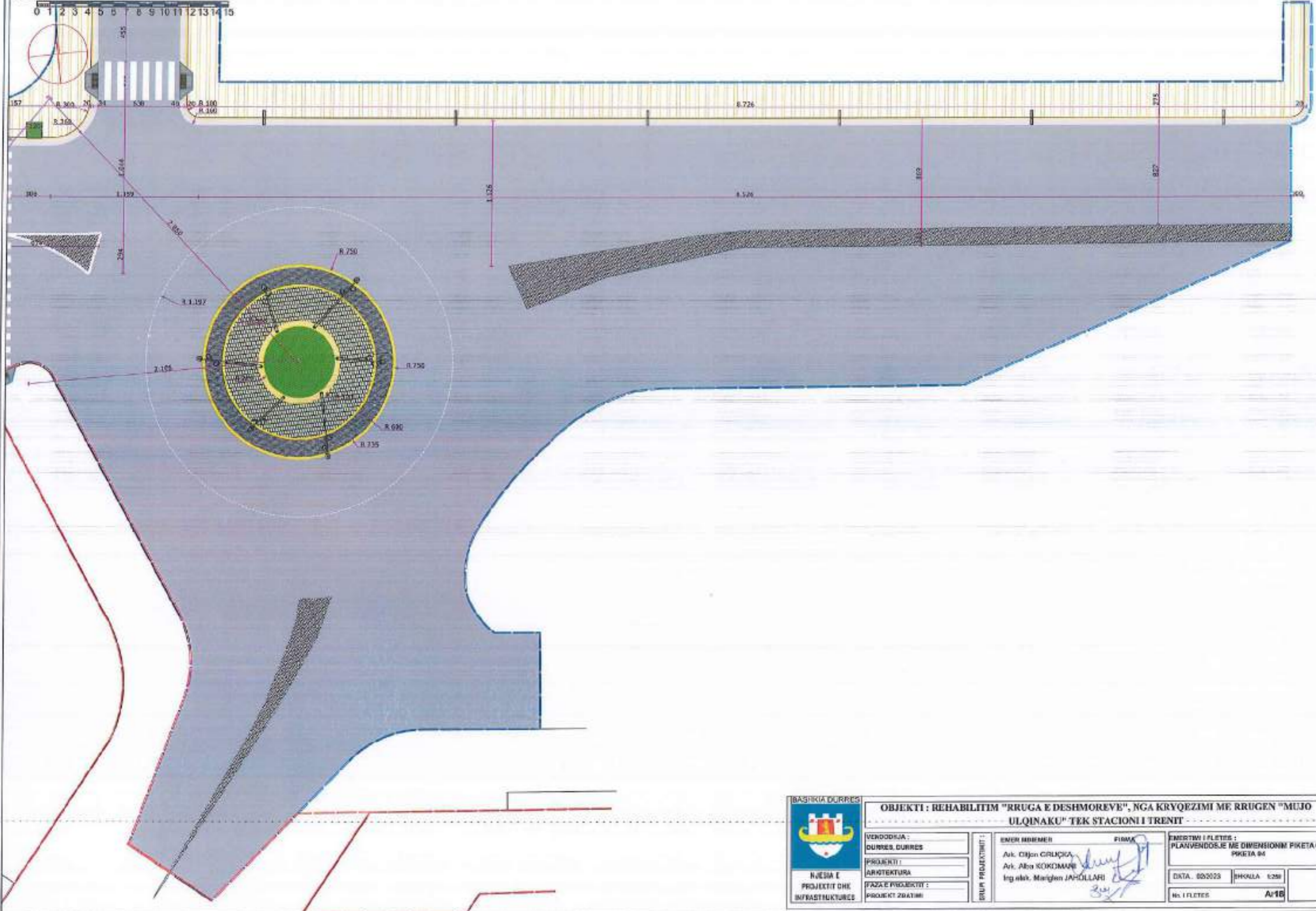

 BASHKIA DURRES NJESIA E PROJEKTIT DHE INFRASTRUKTURES	OBJEKTI : REHABILITIM "RRUGA E DESHMOREVE", NGA KRYQEZIMI ME RRUGEN "MUJO ULQINAKU" TEK STACIONI I TRENIT		EMERTMI I FLETES : PLANVENDOSJE ME DIMENSIONIM PIKETA 01- PIKETA 04		
	VERODHJA : DURRES, DURRES	EMER MBEMER : Ark. Ojjon GRUÇIJA	FIRMA : Ark. Alba KOKOMARI	DATA : 02/2023	SHKALLA : 1:250
	PROJEKTI : ARHITEKTURA	GRUP PROJEKTIMIT : Ing. ark. Mariglen JAHOLLARI		No. I FLETES :	A/18
	FAZA E PROJEKTI : PROJEKT ZBATIMI				

0 1 2 3 4 5 6 7 8 9 10 11 12 13 14 15



OBJEKTI : REHABILITIM "RRUGA E DESHMOREVE", NGA KRYQEZIMI ME RRUGEN "MUJO ULQINAKU" TEK STACIONI TRENIT

VENDOSHA :	EMER BASHKIM	FIRMA	EMERTIMI I FLETES :
DURRES, DURRES	Ark. Olgun GRUÇHA		PLANVENDOSJE ME DIMENSIONIM PIKETA 03- PIKETA 06
PROJEKTI :	Ark. Alba HOKOMANI		DATA : 02/2023
ARKITEKTURA	Ing. Elek. Marigen JAHOLLARI		PIKETA : 1:250
FAZA E PROJEKTI :			NO. FLETES :
PROJEKTI ZBATIM			A19

0 1 2 3 4 5 6 7 8 9 10 11 12 13 14 15

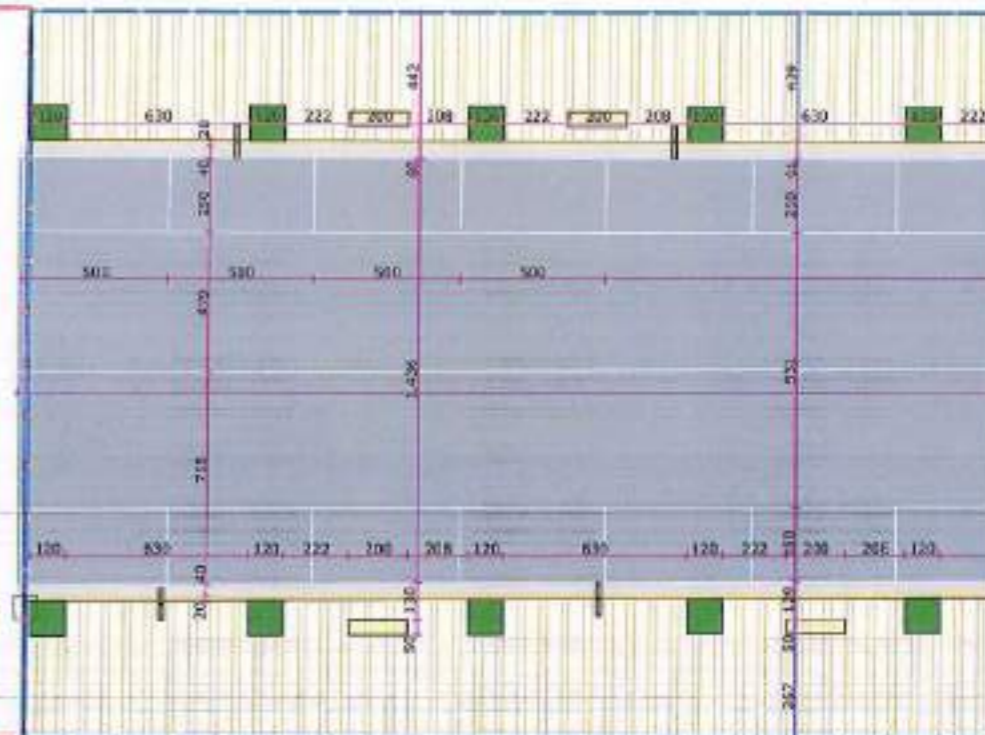

 BASHKIA DURRES NJESIA E PROJEKTI DHE INFRASTRUKTURES	OBJEKTI : REHABILITIM "RRUGA E DESHMOREVE", NGA KRYQEZIMI ME RRUGEN "MUJO ULQINAKU" TEK STACIONI I TRENIT		EMERTIMI I PLETES : PLANVENDOSJE ME DIMENSIONIM PIKETA 03- PIKETA 06		
	VERPORDHJA : DURRES, DURRES	EMER INZHIJER : Ark. Orljon GRUÇIJA Ark. Alba KOKOMANI Ing. Elek. Mariglen JAHOLLARI	FIRMA : 	DATA : 02/02/23	SHALLA : 1:250
	PROJEKTI : ARHITEKTURA	GRUP PROJEKTIMIT :	No. I PLETES :	A/20	
	FAZAE PROJEKTI : PROJEKT ZBATIM				

Det. 1.A

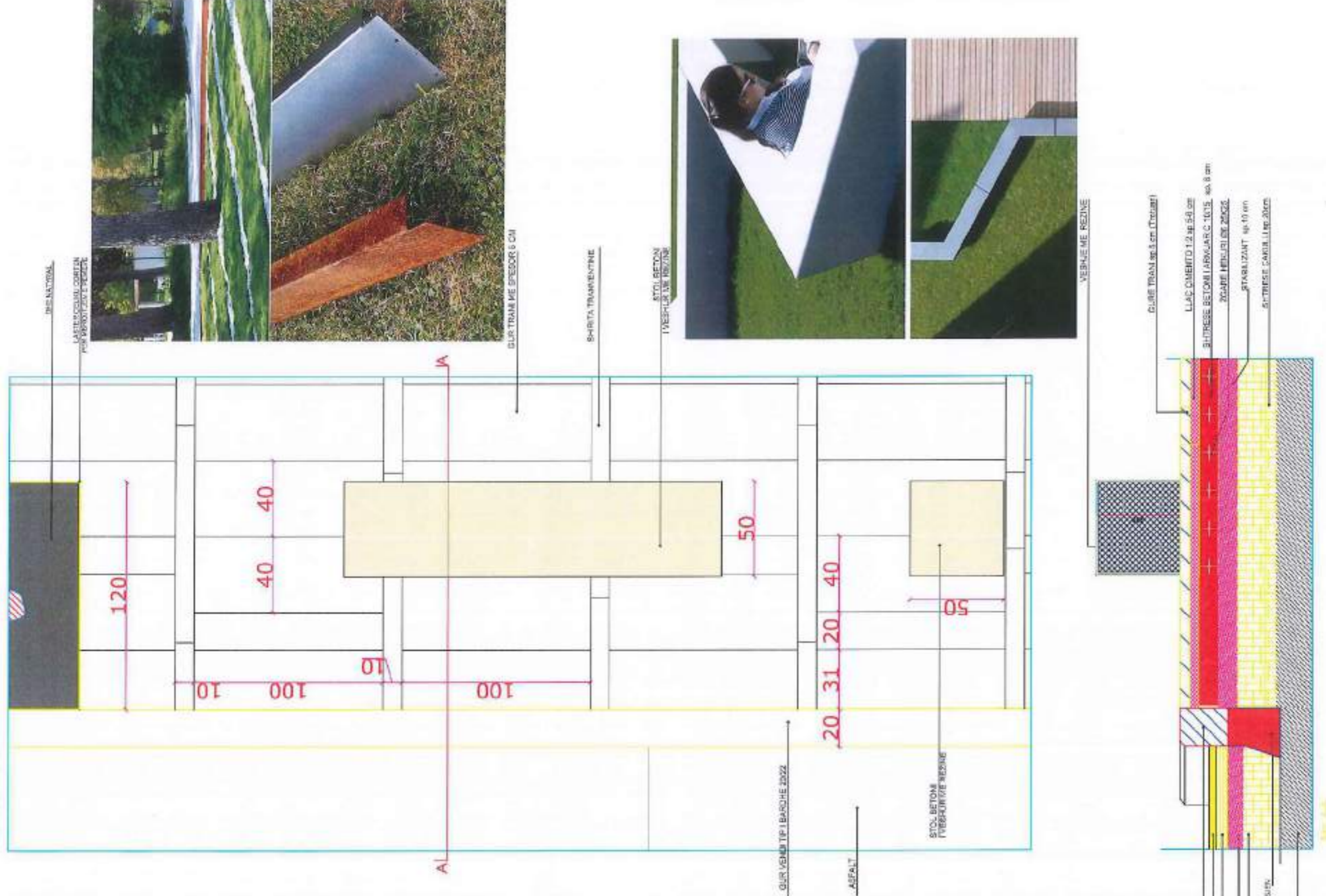

OBJEKTI : REHABILITIM "RRUGA E DESHMOREVE", NGA KRYQËZIMI ME RRUGEN "NGJUU ULQINAKU" TEK STACIONI I TRENTI	
VEREDHORIA :	EMER MBIEMER
DURIMI DUREK :	AIK. OJIPOT GRUÇKA
PROJEKTI :	AIK. ABA KORÇANI
ARHITEKTURA :	ING. ABL. MERIËN JAHOLLARI
FAZAT PROJEKTI :	AIK. BUKA MADH
PROJEKTI ZBATIM :	FIRMA
EMERTIMI I LETES : DETAJE TEKNIKE 1	
DATA : 01/2022	SHKALLA : 1:20
NO. I FLETES	A122

Det. 2.A

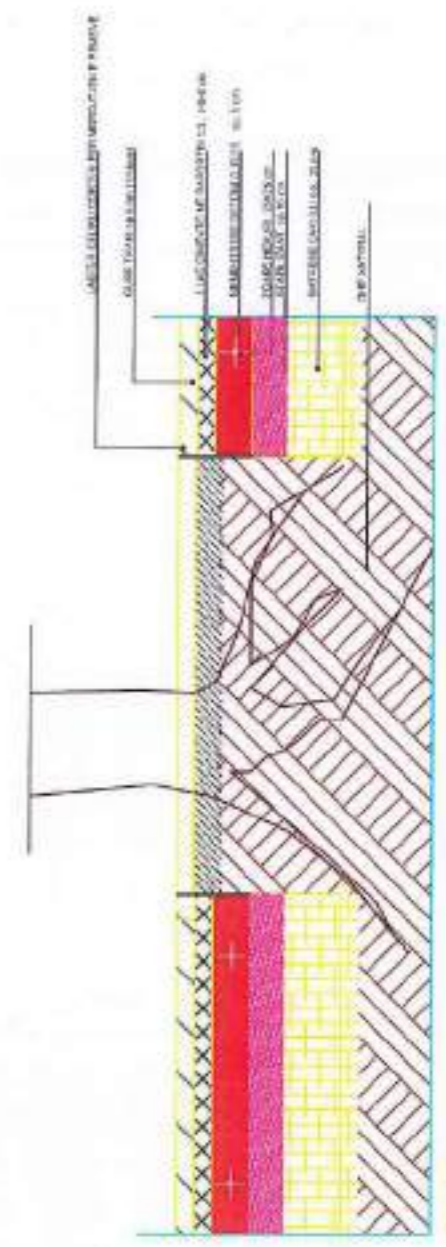
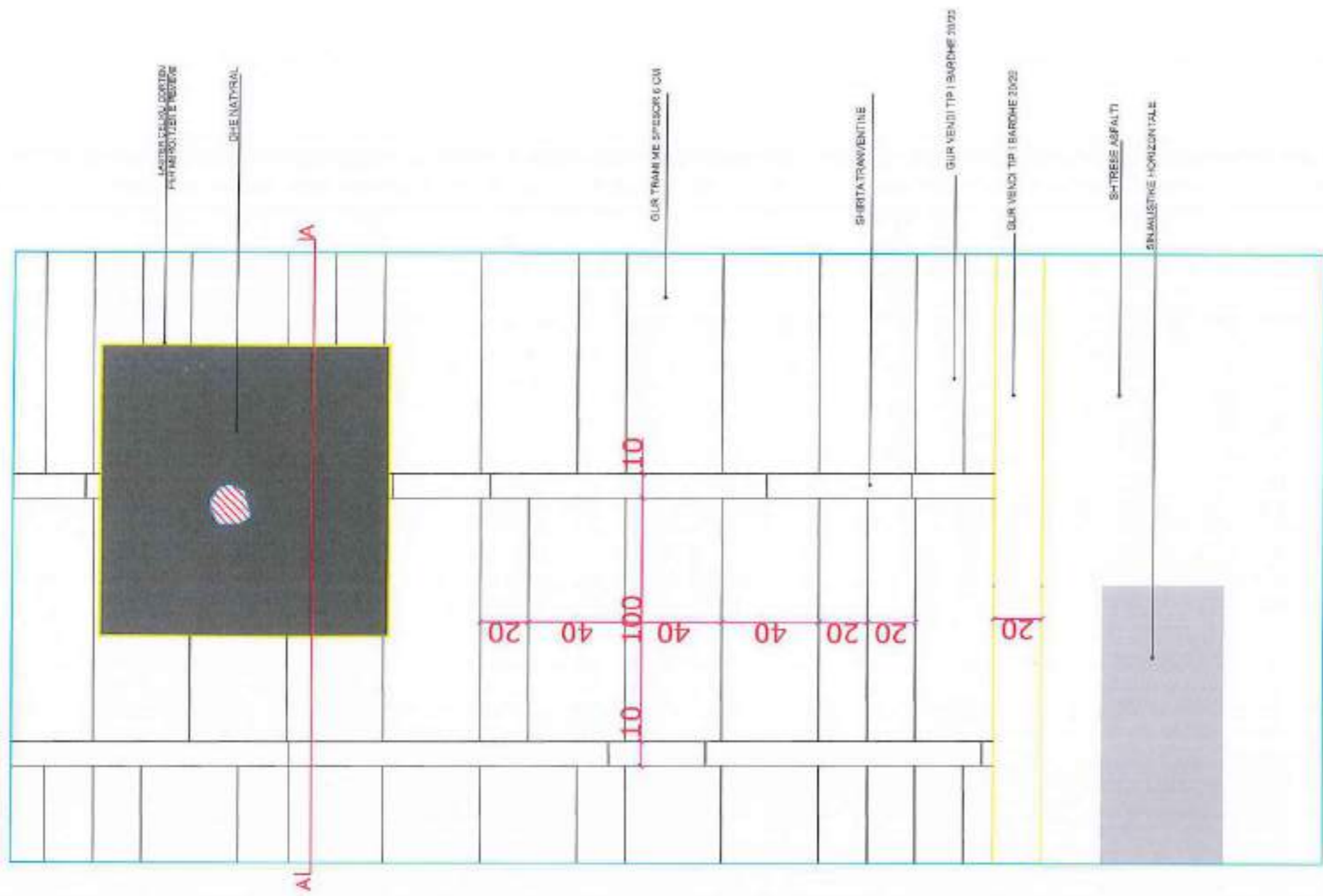

VENDORI: DURESS, DURRES
 PROJEKTI: ARKITEKTURA
 FAZA E PROJEKTIT: PROJEKTIM I DËSHMOREVE
 GRUPI PROJEKTI:

EMER MBIEMER: IRMA
 Art. Olgja GRUÇKA
 Art. Aida KOKOMARI
 Ing. Olga MORGAN JAJ-DALLARI
 Art. Blerta MOÇI

OBJEKTI: REHABILITIM "RRUGA E DËSHMOREVE", NGA KRYQEZIMI ME RRUGEN "MUJO UL-QINAKU" TEK STACIONI I TRENIT
 EMERTIMI I FLETES: DETAJE TEKNIKE 2
 DATA: 01/2023
 NO I FLETES: A/23

Det. 3.A

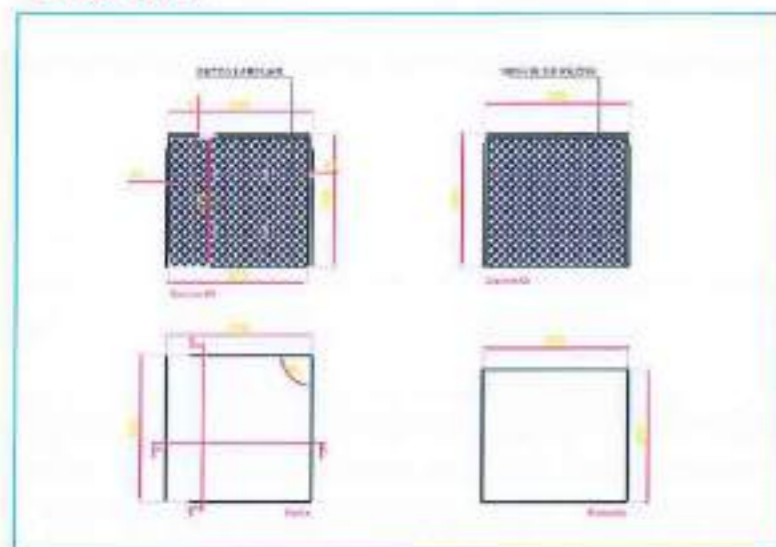

Det. 3/1.A

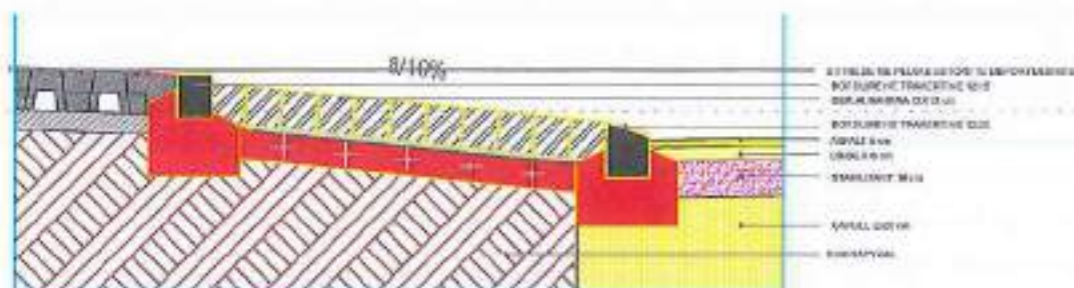
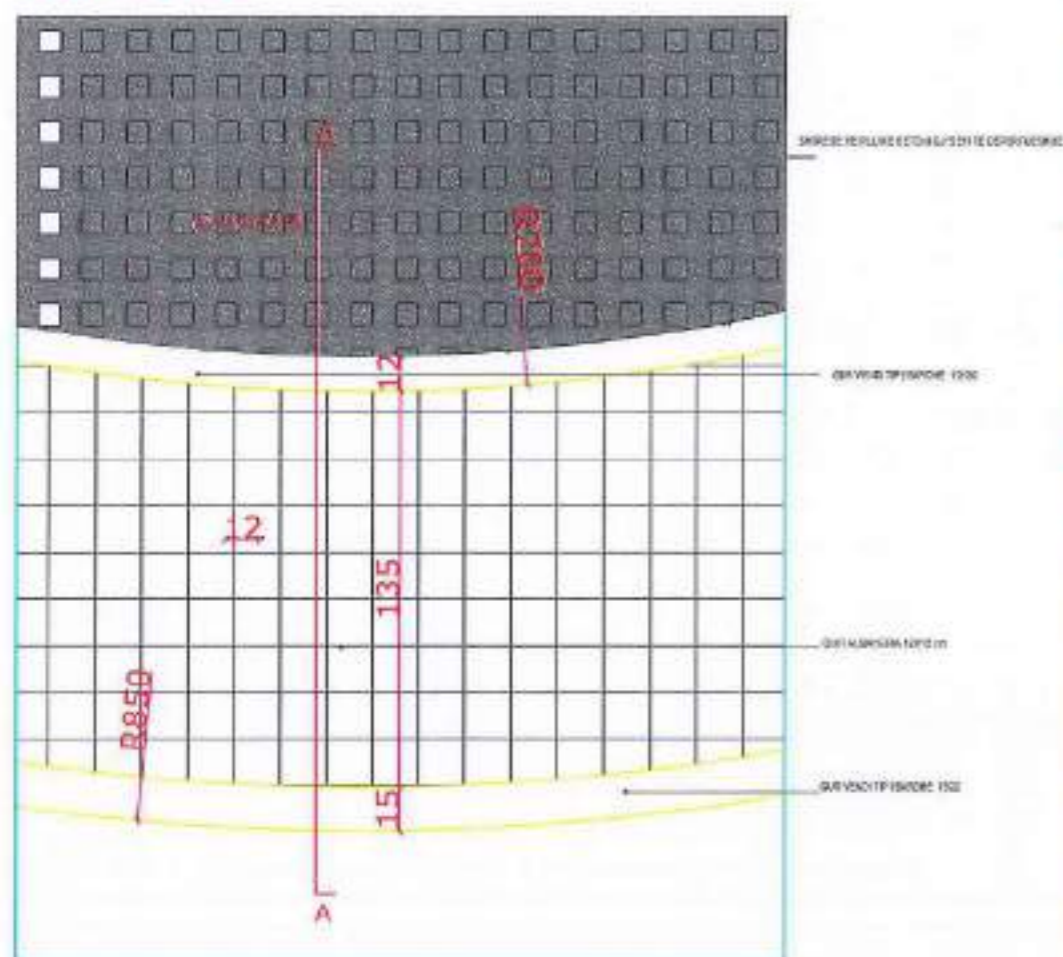

 <p>BASHKIA E DURRËS</p> <p>NJESIA E PROJEKTIT DHE INFRASTRUKTURËS</p>	<p>OBJEKTI : REHABILITIM "RRUGA E DESHMOREVE", NGA KRYQEZIMI ME RRUGEN "MUJO ULQINARU" TEK STACIONI I TRENIT</p>	
	<p>VENDOBËJA : DURRËS, DURRËS</p> <p>PROJEKTI : ARHITEKTURA</p> <p>FAZË E PROJEKTIT : PROJEKTI ZBATIMI</p>	<p>EMER BUREVEZ : FIRMA</p> <p>Arç. Orljon ORUÇKA</p> <p>Arç. Alba KOKOMAN</p> <p>Ing. etek. Nergjon JAVOLLARI</p> <p>ARK. DIJANKA MADH</p>

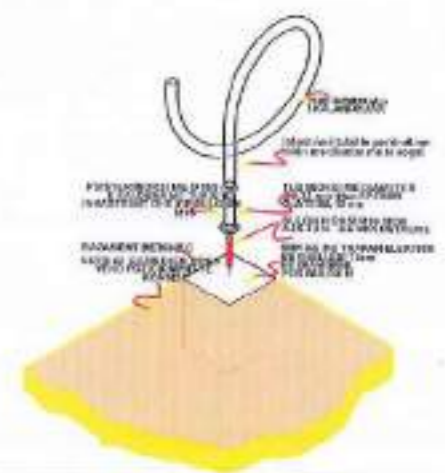
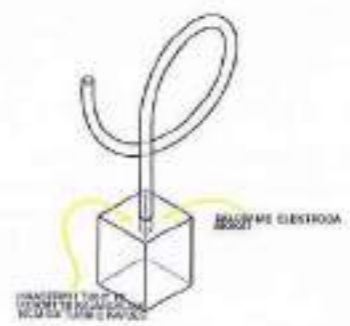
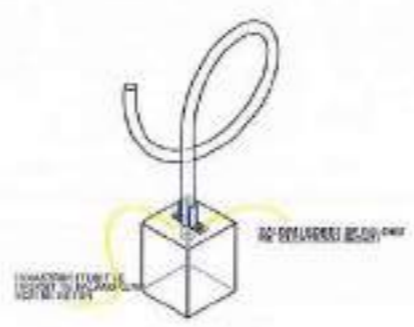
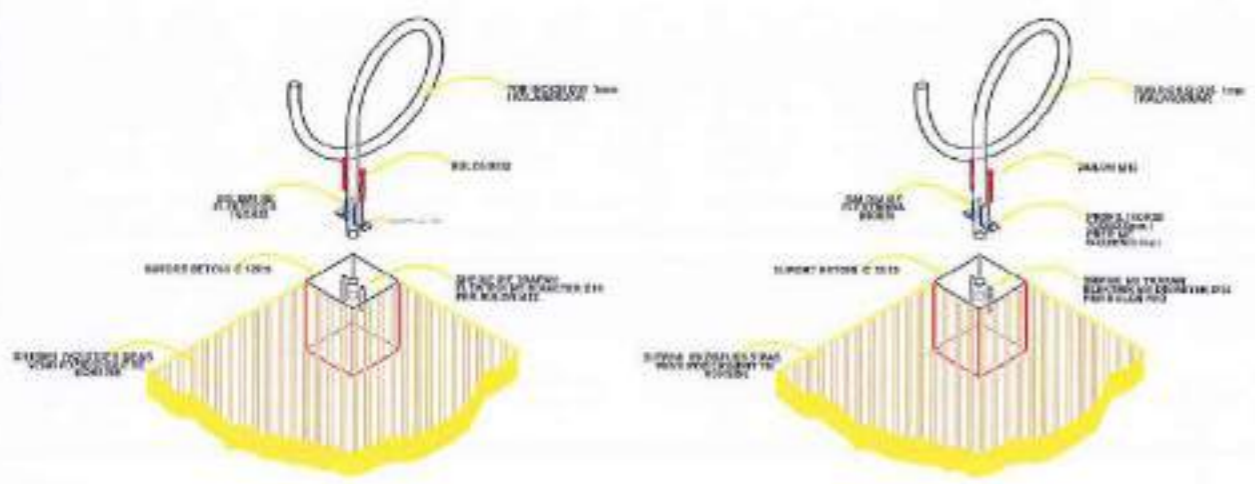
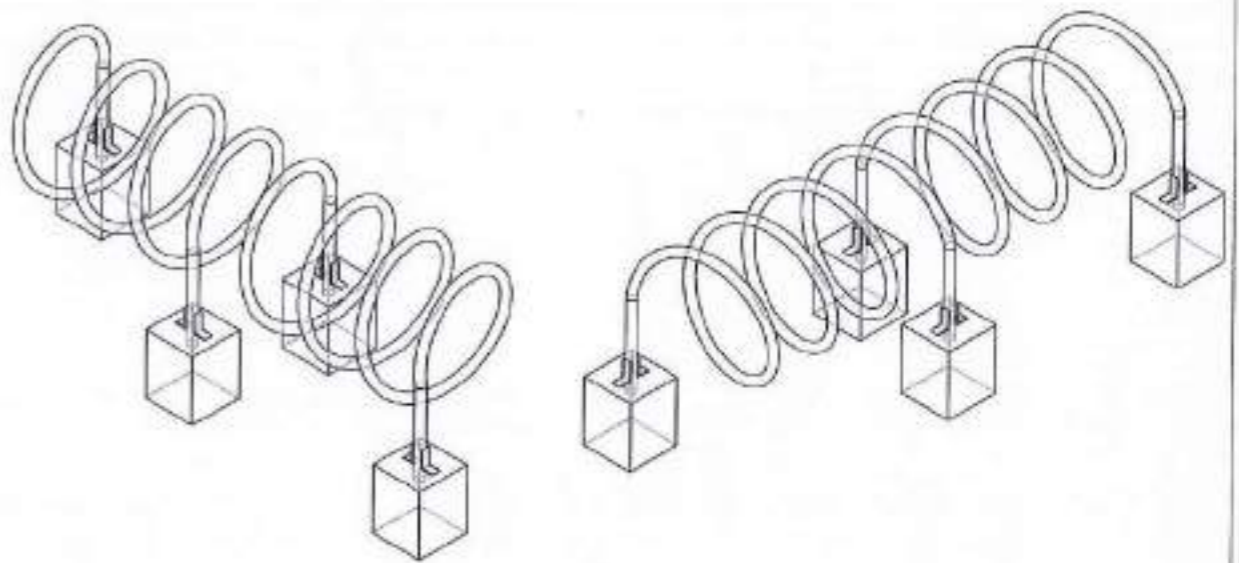
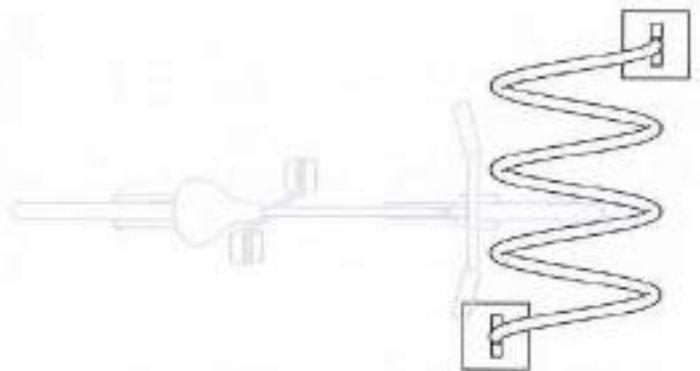
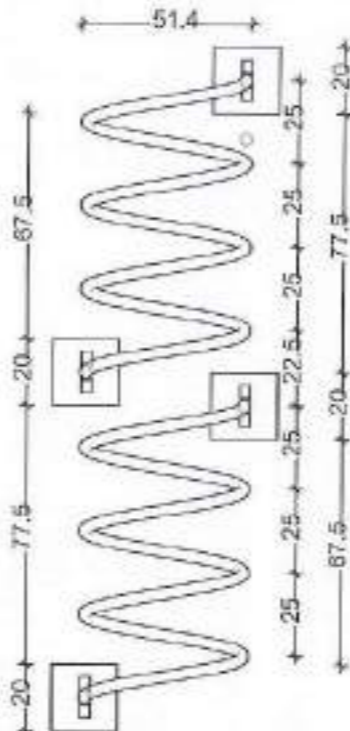
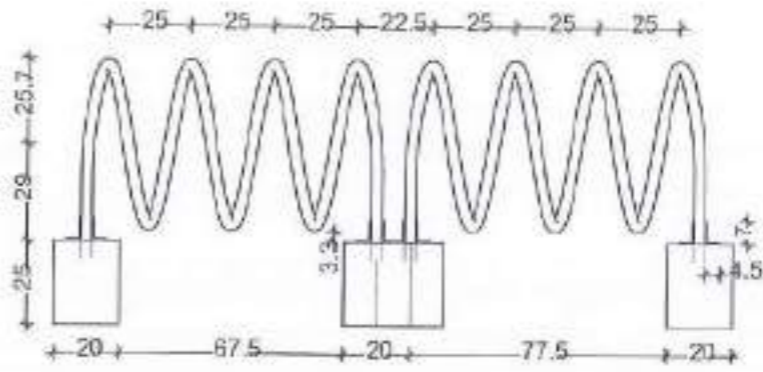
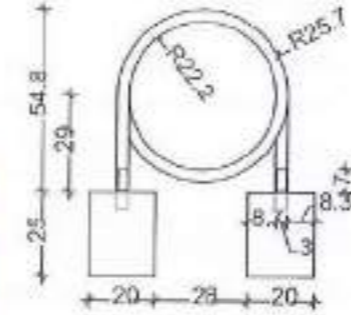
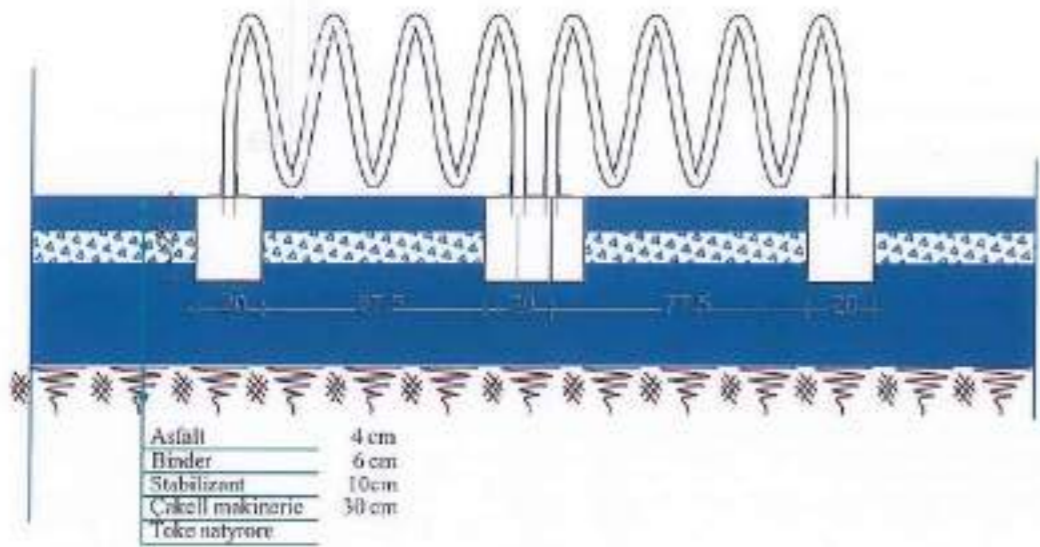

<p>BASHKIA E DURRËS</p> <p>NAJESIA E PROJEKTIT DHE INFRASTRUKTURËS</p>	OBJEKTI: REHABILITIM "RRUGA E DSHMOREVE", NGA KRYQEZIMI ME RRUGEN "MUJO ULOQNAKU" TEK STACIONI I TRENIT				
	YENDODIMA: DURRËS, DURRËS	EMER MBIEMER Ark. Orijon GRUÇKA Ark. Alba KOKOMMI Inj. Lek. Mariglen JAHOLLARI Ark. Blanka MADHI	FRIDA 	EMERTIMI I FLETES: DETAJE ARKITEKTONIKE VENDEQENDRIMET E BICIKLETAVE	
	PROJEKTI: ARKITEKTURA			DATA: 2023	SHKALLA:
	PAKUJË PROJEKTORE: PROJEKT ZBATIMI			Nr. / FLETES: A/25	



		OBJEKTI : REHABILITIM "RRUGA E DESHMOREVE", NGA KRYQEZIMI ME RRUGEN "MUJO ULQINAKU" TEK STACIONI I TRENIT	
VENDORRJA : DURRES, DURRES	EMER MUEMER	FIRMA :	EMERTIMI I FLETES : PAMJE 3D
PROJEKTI : ARHITEKTURA	Ark. Orlon GRUÇKA Ark. Aibe KOKOMANI		DATA : 02/2023
FAZAT PROJEKTI : PROJEKT ZBATIM	Inj.elek. Mariglen JAHOLLARI 	No. FLETES :	SHALLA : AIRE

BASHKIA DURRES



BASHKIA DURRES

OBJEKTI:

**REHABILITIM "RRUGA E DESHMOREVE", NGA KRYQEZIMI ME
RRUGEN "MUJO ULQINAKU" TEK STACIONI I TRENIT
(PROJEKT KUZ / KUB)**



DURRES, 2023

NJESIA E PROEJKTIT DHE INFRASTRUKTURES

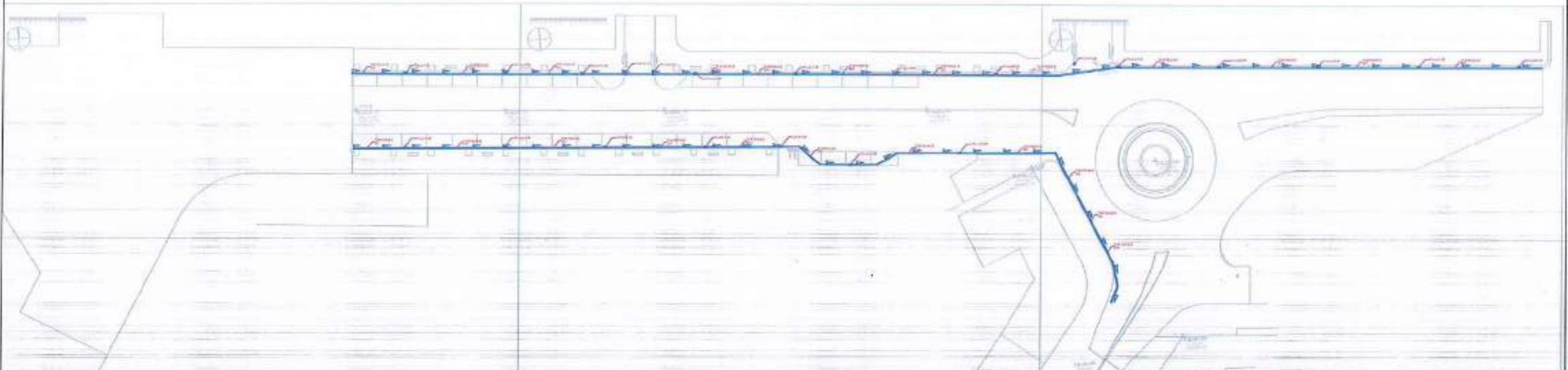

SHËNIM TEKNIK:

- SISTEMI I KULLIMIT TË UJËRAVE ATMOSFERIKE (SKUA) TË RRUGËS DO TË JETË ME VETËRRUEDHJE NGA PUSËTA E PARË DERI NË PIKËN E SHKARKKMIT.
- SISTEMI I KULLIMIT TË UJËRAVE ATMOSFERIKE ËSHTË E NDARË NË DISA NËNSISTEME TË PAVARJARA NGA NIERA TË TËRA, PËR ARSYE TË THËLLËSISË SË MADHË QË ARRIN LINIA E KUA, SECILA PREJ PËSËVE KULLON UJËRAT E KË NËPËSIRË TË ÇAKTUAR TË RRUGËS.
- VEPRAT SHIMBLEDHËSE DO TË JENË - PILETA ME PËRMASA 30 x 30 cm OSE 50 x 30 cm.
- PUSËTA ME ZGARË GJDE SFEROIDALE (GS) 70 x 40 cm, NË PËSËN E RRUGËS TË MBËSHËTUR MBI TABAN NATYRAL APO MBI MBUSHJE ME DHË, SI DHË NË NËNKALIME.
- TUBACIONET DO TË JENË ME MATERIAL HDPE SIB, PRODHUARA SIPAS EN 13476. TË BRINJUARA ME DY SHTRËSA (SHTRËSA E JASHTME E BRINJUAR DHË SHTRËSA E BRENDSHME E LËMUAR) NË PËSËN E RRUGËS TË MBËSHËTUR MBI TABAN NATYRAL APO MBI MBUSHJE ME DHË.
- TUBACIONET DO TË KENË DIAMETRAT SI NË VIZATIME.
- PUSËTAT SHIMBLEDHËSE DHË ATO TË KONTROLLIT, DO TË JENË ME MATERIAL B/A TË KLASËS C25/30 ME CIMENTO SULFATIKË. KAPAKËT E PUSËTAVE DO TË JENË TË KLASËS C250 PËR PUSËTAT NË KUNJETA DHË D400 PËR PUSËTAT QË MUND TË JENË NË KORSIËNË E NJETËVE MOTORIKE.
- THËLLËSIA MINIMALE E KURDORËS SË TUBACIONIT NËN KUNJËTË DO TË JETË h = 50 cm, KURSE THËLLËSIA MINIMALE E KURDORËS SË TUBACIONIT NËN KORSIËNË E NJETËVE MOTORIKE DO TË JETË h = 100 cm. MBUSHJA DHË NGËRSHJA E MATERIALEVE NËN, ANËS DHË MBI TUBACIONIN DO TË REALIZOHET ME SHTRËSA SIPAS SPECIFIKIMEVE TEKNIKE DHË SIPAS STANDARDEVE EUROPIANE (EN 1610, EN 752, etj.)
- NË THËLLËSI TË KANALIT MBI 1.5 m, TË VENDOSIN MURE MBAJTËSE TË PËRKOSHME (PALANKOLA, BOKSE, etj.) PËR TË SIGURUAR MURËT E KANALIT NGA RRËSHQITJA E TYRE. GËTHASHTU DHË NË PUNIMET E PUSËTAVE APO VEPRAVE TË TËRA, ME THËLLËSI MBI 1.50 m, TË VENDOSIN MURE MBROJTËSE TË PËRKOSHME (PALANKOLA, BOKSE, etj.)
- PËRRËSIA MINIMALE E TUBACIONEVE DO TË JETË $p_{min} = 1/100$ [mm]. NË PËSË TË ÇAKTUARA TË RRUGËS, PËRRËSIA E TUBACIONEVE DO TË JETË E NJËTË ME PËRRËSINË E RRUGËS (SHIH PROFILIN GJATËSOR).



OBJEKTI: REHABILITIM "RRUGA E DESHMOREVE", NGA KRYQEZIMI ME RRUGEN "MUJO ULQINAKU" TEK STACIONI TRENTIT

VENDOSJA:
DURRES, DURRES

PROJEKTI:
KURBUZ

FAZJA E PROJEKTI:
PROJEKT ZBATIM

CSUPI PROJEKTI:

EMER MBIEMER
Ark. Orlan GRUÇKA
Ark. Albi KOKOMANI
Ing. Ark. Merigjon JANOLLARI

EMERTIMI I FLETËS:
PLANVENDOSJE KUR

DATA: 02/2023 SHALLA 1.1.179

Nr. I FLETËS: 104

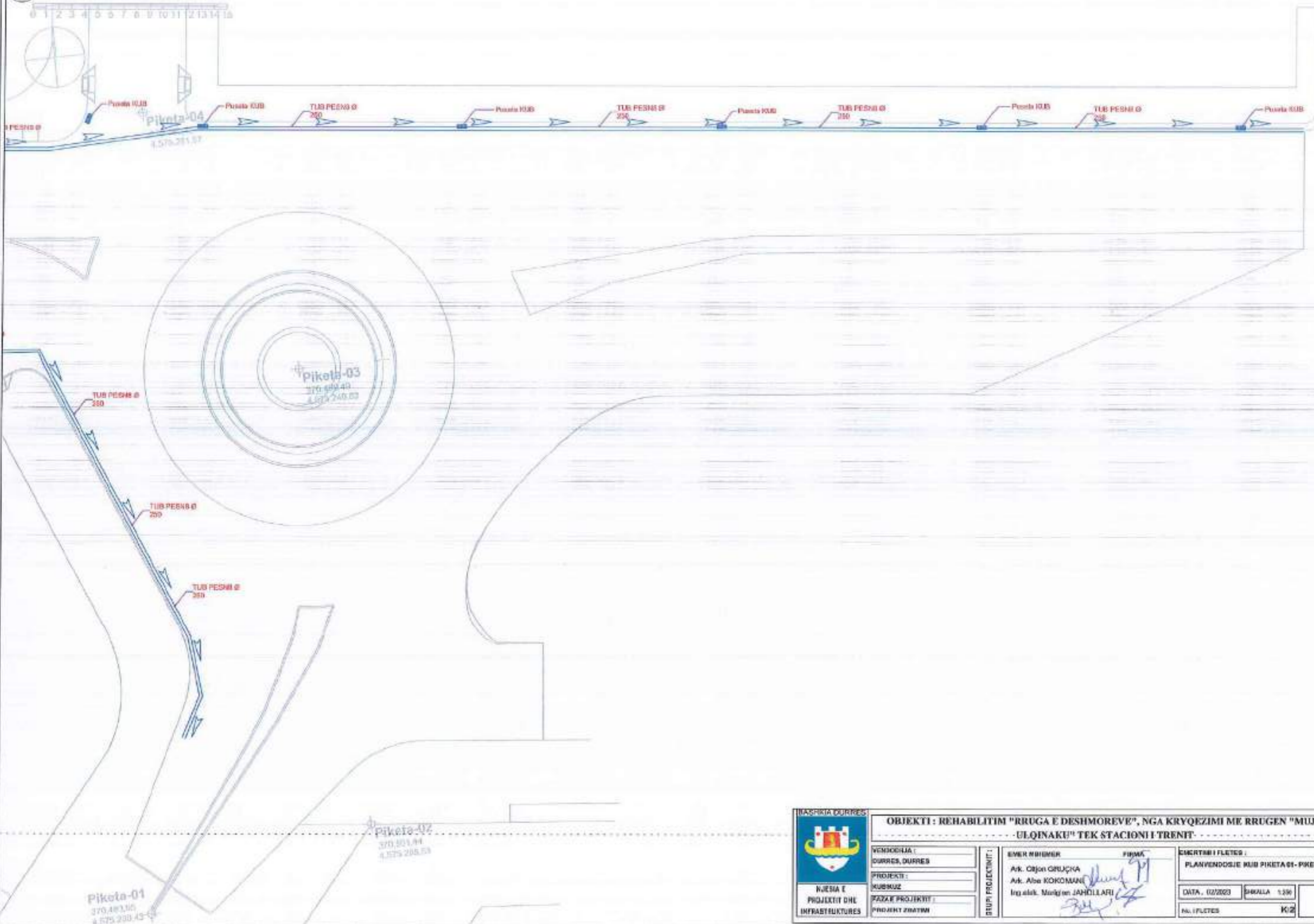

 <p>REPUBLICA E SHqipërisë KOMUNA E DURRES</p>	<p>OBJEKTI : REHABILITIM "RRUGA E DESHMOREVE", NGA KRYQEZIMI ME RRUGEN "MUJO ULQINAKU" TEK STACIONI I TRENT</p>		<p>EMERTIMI I FLETES : PLANVENDOSJE RREZ PIKETA 01- PIKETA 04</p>	
	<p>VENDOSJA : DURRES, DURRES</p> <p>PROJEKTI : KUBRIZ</p> <p>FAZA E PROJEKTI : PROJEKT ZBATIM</p>	<p>GRUPI PROJEKTI :</p>	<p>EMER MBIEMER : Ark. CILJON GRUÇKA Ark. ALOE KOKOMANI Inzh. elik. MURGJON JAHOLLARI</p>	<p>FIRMA :</p>

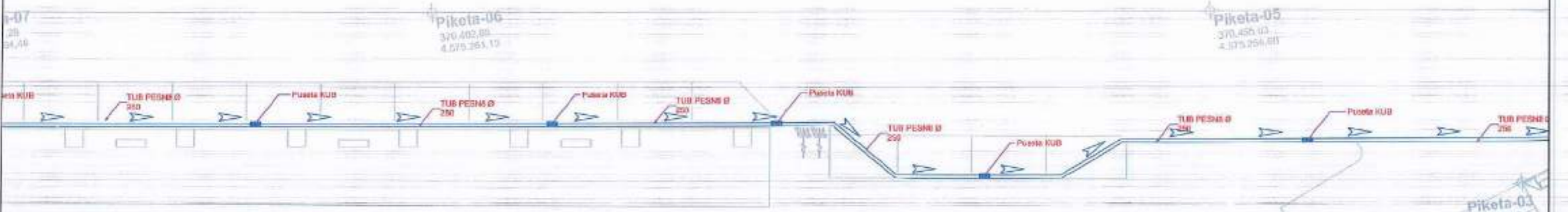
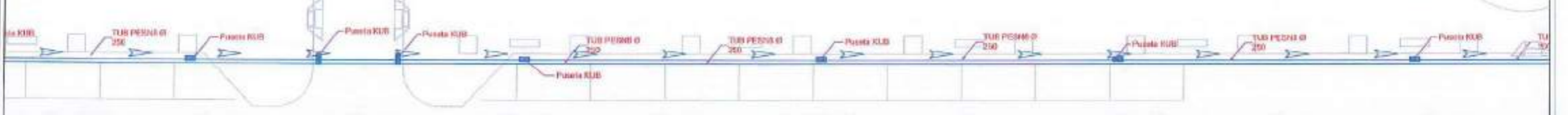

Piketa-06
370.402,00
4.575.263,13

Piketa-05
370.456,03
4.075.254,03

Piketa-03
370.474,20
4.575.241,00

 BASHKIA DURRËS NJESIA E PROJEKTIT DHE INFRASTRUKTURES	OBJEKTI: REHABILITIM "RRUGA E DESHMOREVE", NGA KRYQEZIMI ME RRUGEN "MUJO ULQINAKU" TEK STACIONI I TRENIT		
	VENDOSHA: DURRES, DURRES	EMER MBISHER Ark. Otjan GRUJKA Ark. Albi KOKOMANI Ing.olek. Marigen JAHOLLARI	FIRMA 
	PROJEKTI: KUBRIZ	EMERTIMI I FLETES: PLANVENDOSJE NIB PIKETA 03- PIKETA 06	DATA: 02/2023 BRIGJATA: 1/254
	FAZJA E PROJEKTIT: PROJEKTI ZBATIM	GRUPI PROJEKTIMIT: 	No. I FLETES: K03

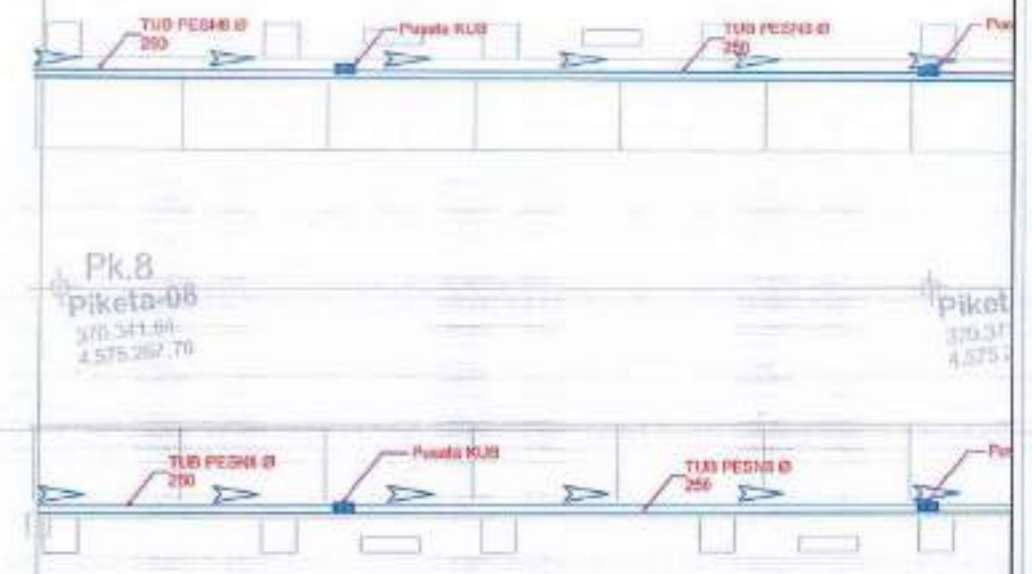

 BASHKIA DURRËS NJESIA E PROJEKTE DHE INFRASTRUKTURES	OBJEKTI : REHABILITIM "RRUGA E DESHMOREVE", NGA KRYEZIMI ME RRUGEN "MUJO ULQINAKU" TEK STACIONI TRENIT		
	VENDOSJA : DURRËS, DURRËS	GRUPI PROJEKTIMI : BASHKIA DURRËS	EMERTIMI I FLETES : PLANVENDOSJE KUJ PIKETA 07- PIKETA 08
	PROJEKTI : KUNDOZ		DATA : 02/2023 SHKALLA : 1:250
	FAZA E PROJEKTE : PROJEKT ZBATIM	EMER MIEVNER : Ark. Orlan GRUÇKA Ark. Alba KOKOMANI Ing. Elek. Mariglen JAFOLLARI	FIRMA : 

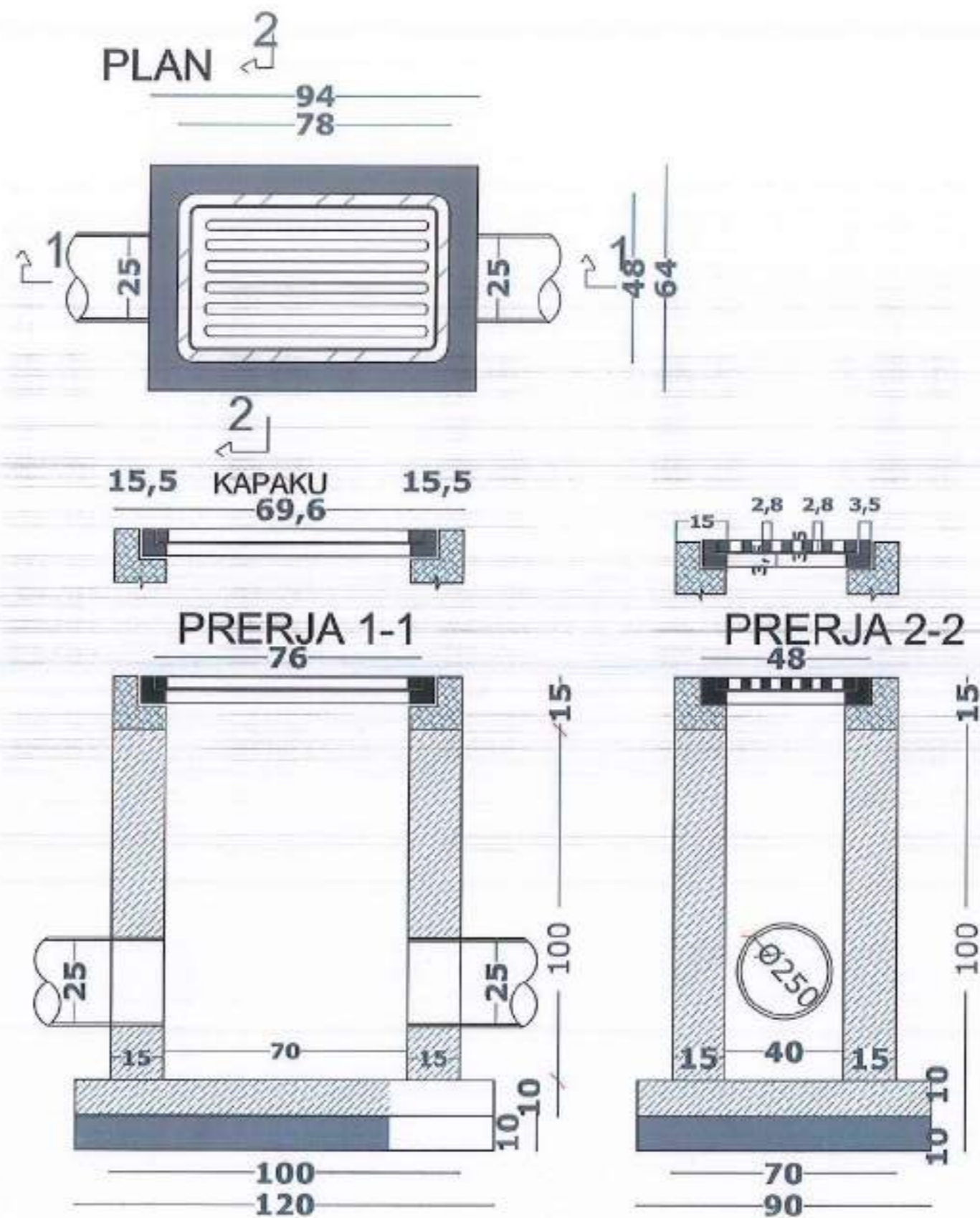

<p>NJESIA E PROJEKTIIT DHE INFRASTRUKTURES</p>	OBJEKTI : REHABILITIM "RRUGA E DESHMOREVE", NGA KRYQEZIMI ME RRUGEN "MUJO ULQINAKU" TEK STACIONI TRENIT			
	VENDORIJA : DURRES, DURRES	EMER MBIEMER : Ark. Orljon GRUÇKA Ark. Albi KOKOMANI Ing. enk. Mergjen JAHOLLARI	FORMA : 	EMERTIMI I FLETES : DETAJE PUSETA KUB
	PROJEKTI : KUBRIZ	GRUPI PROJEKTIIT :	DATA : 02/2023	SHKALLA : 1:15
	FAZA E PROJEKTIIT : PROJEKT ZBATIM	Nr. i FLETES :	K15	

BASHKIA DURRES



BASHKIA DURRES

OBJEKTI:

**REHABILITIM "RRUGA E DESHMOREVE", NGA KRYQEZIMI ME
RRUGEN "MUJO ULQINAKU" TEK STACIONI I TRENIT
(PROJEKT ELEKTRIK)**



DURRES, 2023

NJESIA E PROJEKTIT DHE INFRASTRUKTURES

1

0 1 2 3 4 5 6 7 8 9 10 11 12 13 14 15

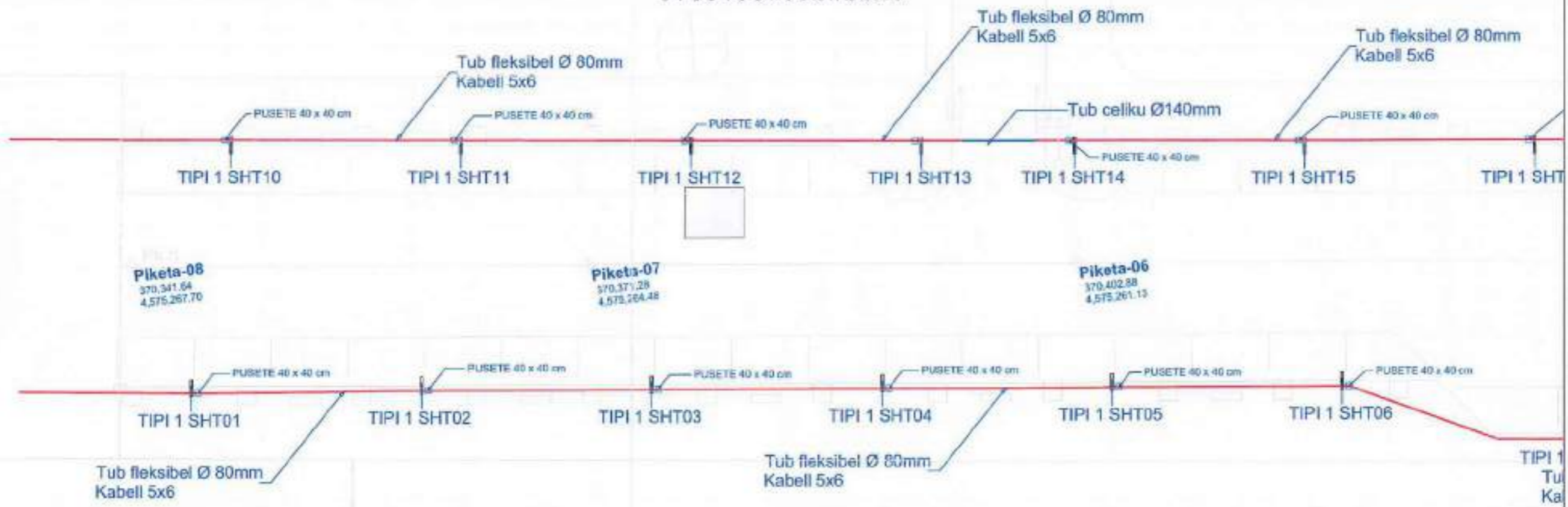

 <p>MINISTRIA E PROJEKT DHE INFRASTRUKTURES</p>	<p>OBJEKTI: REABILITIM "RRUGA E DESHMOREVE", NGA KRYQEZIMI ME RRUGEN "MIRAO ULQINAKU" TEK STACIONI I TRUNIT</p>		
	<p>VENDOSJA:</p>	<p>NUMERIMETRI</p>	<p>SHKURTIMI FLETES:</p>
	<p>PROJEKTI:</p>	<p>Ar. Ojpa GRUÇKA Ar. Miro BDIÇKANI Ar. Bunko Mëdë</p>	<p>PLANI VENDOSJE NDRICIMSHIT 01- SHT 06 DHE SHT 07-SHT 15</p>
	<p>PROJEKTI:</p>	<p>Ar. Bunko Mëdë</p>	<p>DATA: 09/02/2021</p>
<p>FAZA E PROJEKTIT:</p>	<p>PROJEKT ZGJIDHJE</p>	<p>SHALLA: 1/200</p>	
<p>PROJEKT ZGJIDHJE</p>	<p>ORIN E PUNESIMIT:</p>	<p>NO FLETES: E-01</p>	

2

0 1 2 3 4 5 6 7 8 9 10 11 12 13 14 15

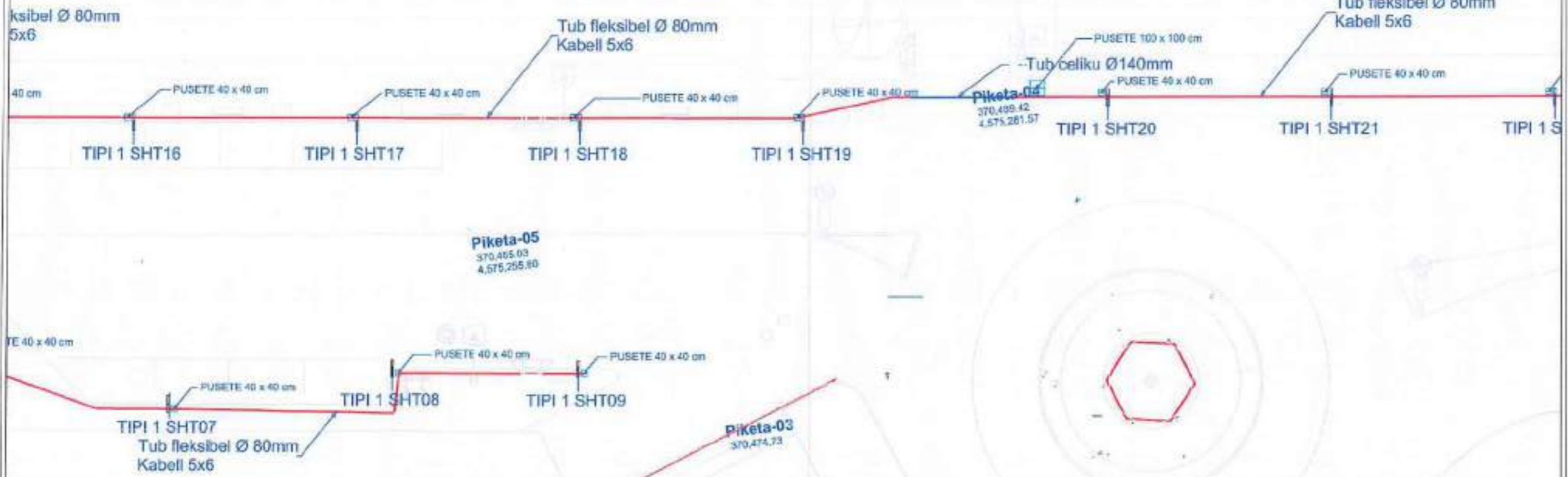

 NEDIA C PROJEKTI DHE INFRASTRUKURES	OBJEKTI : REHABILITIM "RRUGA E DESHMOREYE", NGA KRYQEZIMI ME RRUGEN "MUJO ULQINAKU" TEK STACIONI TRENIT		
	VENDORIA : DARRIS, DARRIS	ENJENJERIMET : ENJENJERIMET : Ark. OJAZ GRUÇKA Ark. ABE KURÇOMAN Ark. Elona Mada Inj. Arak. Marjlen JAHOLLARI	EMERTIMI I PLANET : PLANI VENDOSJE NDRICIMI SHT 02 - SHT 09 DHE SHT 16 - SHT 21
	PROJEKTI : ELEKTRIK	DATA : 05/2021	BHALLA : 1290
	FIDA E PROJEKTI : PENCURRI ZEMRIMI	BILI FLITES :	E-02

3



 <p>MINISTRIA E INFRASTRUKTURËS</p>	OBJEKTI: REHABILITIM "RRUGA E DESHMORËVË", NGA KRYQEZIMI ME RRUGEN "MUR OULQINAKU" TEK STACIONI I TRENTI		
	VERIMORJA: SHKURT. DARRËS	SHKURT. VENDORI:	SHKURT. I FLETËS:
	PROJEKTI: VERIMORJA	AS. OJON DRUÇKA AS. ABE KOKOMAN AS. BILAL MASHI	PLANI VENDOSJE NDRICIMI SHT 01-SHT 08 DHE SHT 21-SHT 25
	PAGA E PROJEKTI: PROJEKT. SHKURT.	INZH. MERIËN ARHOLLARI	DATA, CODESTI, SHKURT. I FLETËS: No. FLETËS: C-03

SKEMA E KUADRIT ELEKTRIK KEN 1

REABILITIM "RRUGA E DESHMOREVE", NGA KRYQEZIMI I SHESHIT "PRANVERA", TEK KRYQEZIMI ME RRUGEN "MUJO ULQINAKU"

SKEMA E KUADRIT ELEKTRIK KUADRI

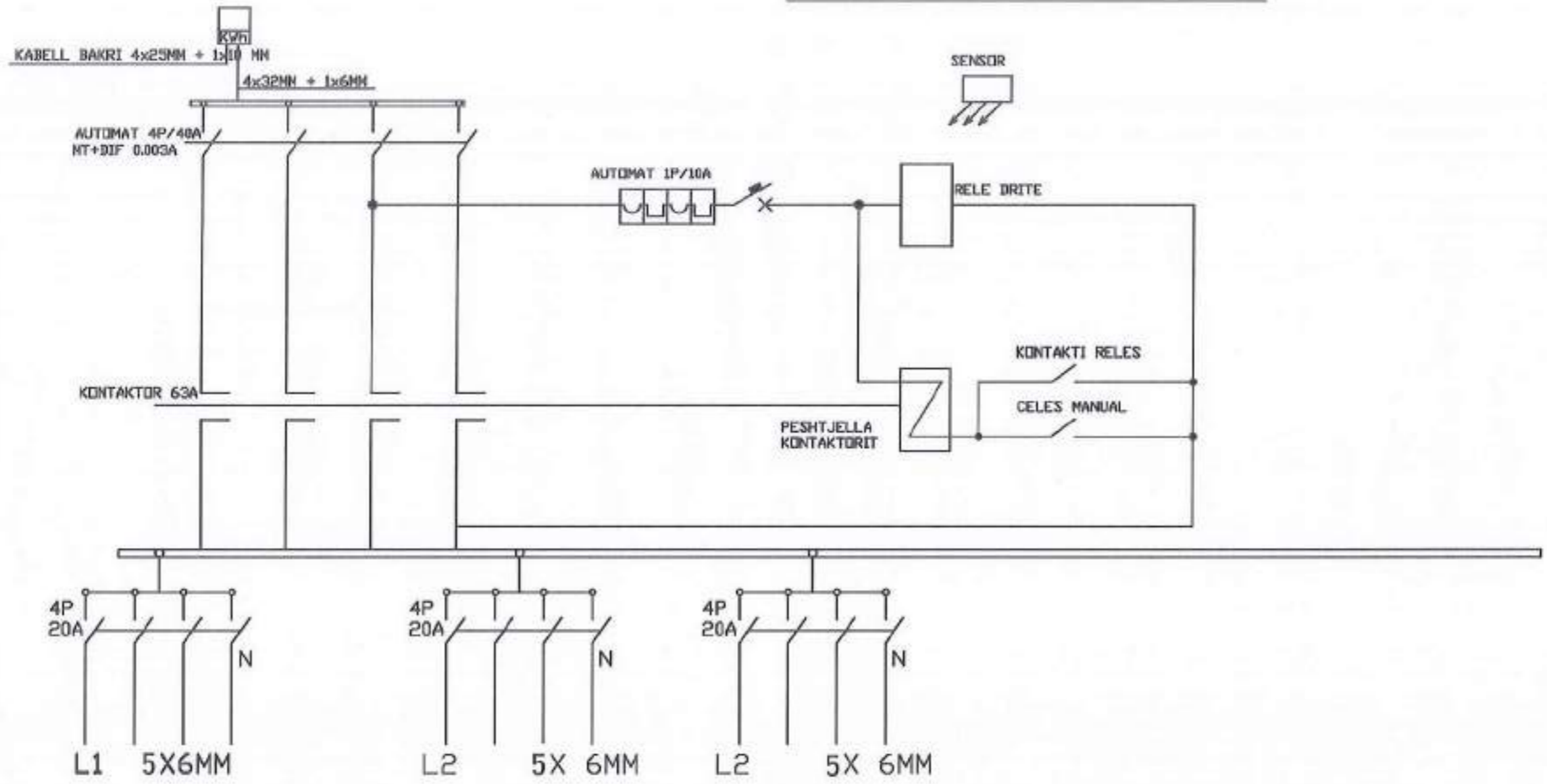

 <p>MINISTRI E PROJEKTIT DHE INFRASTRUKTURES</p>	OBJEKTI: REABILITIM "RRUGA E DESHMOREVE", NGA KRYQEZIMI ME RRUGEN "MUJO ULQINAKU" TEK STACIONI I TRENIT			
	VENDORIJA: DURRES, DURRES	EMER BIRIMES Ark. Ojton GRUÇKA Ark. Alba KOCOMANI Ark. Mergim JAHOLLARI Ark. Blerida MEXHI	PRIMO:	EMERTIMI I FLETES: KUADRI ELEKTRIK
	PROJEKTI: ELEKTRIK	GRUPI PROJEKTIMIT:	DATA: 01/02/23	SHALLA:
	FAZA E PROJEKTEVE: PROJEKT ZBATIMI	No. I FLETES: E104		

Prerje Terthore e tubacionit ne rruge

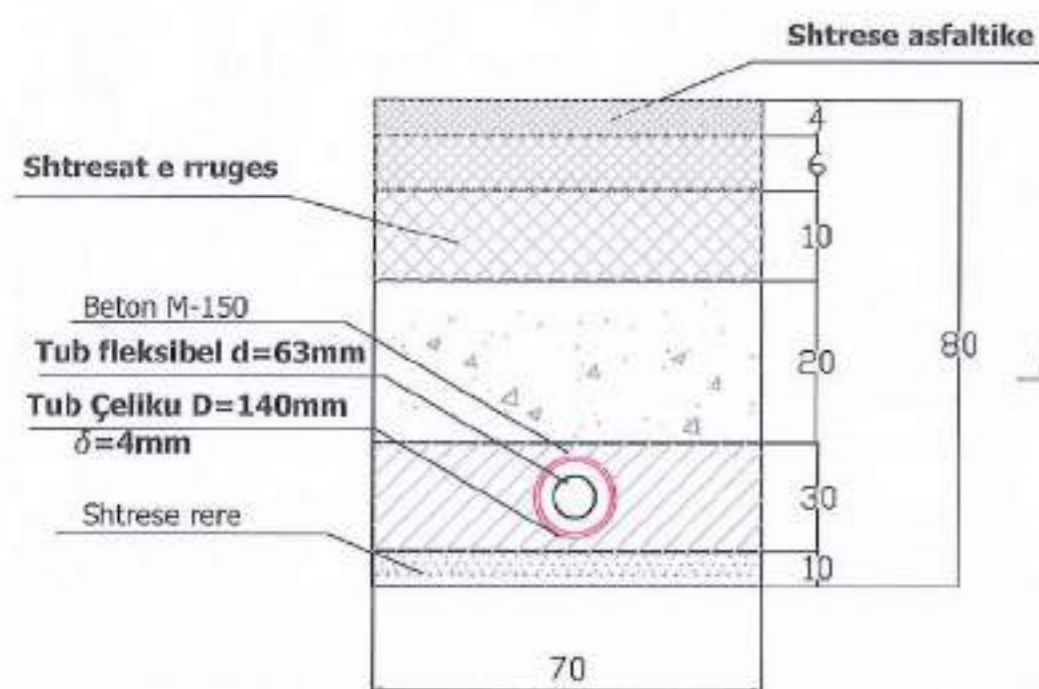

Prerje Gjatesore e tubacionit ne trotuare dhe pusetave

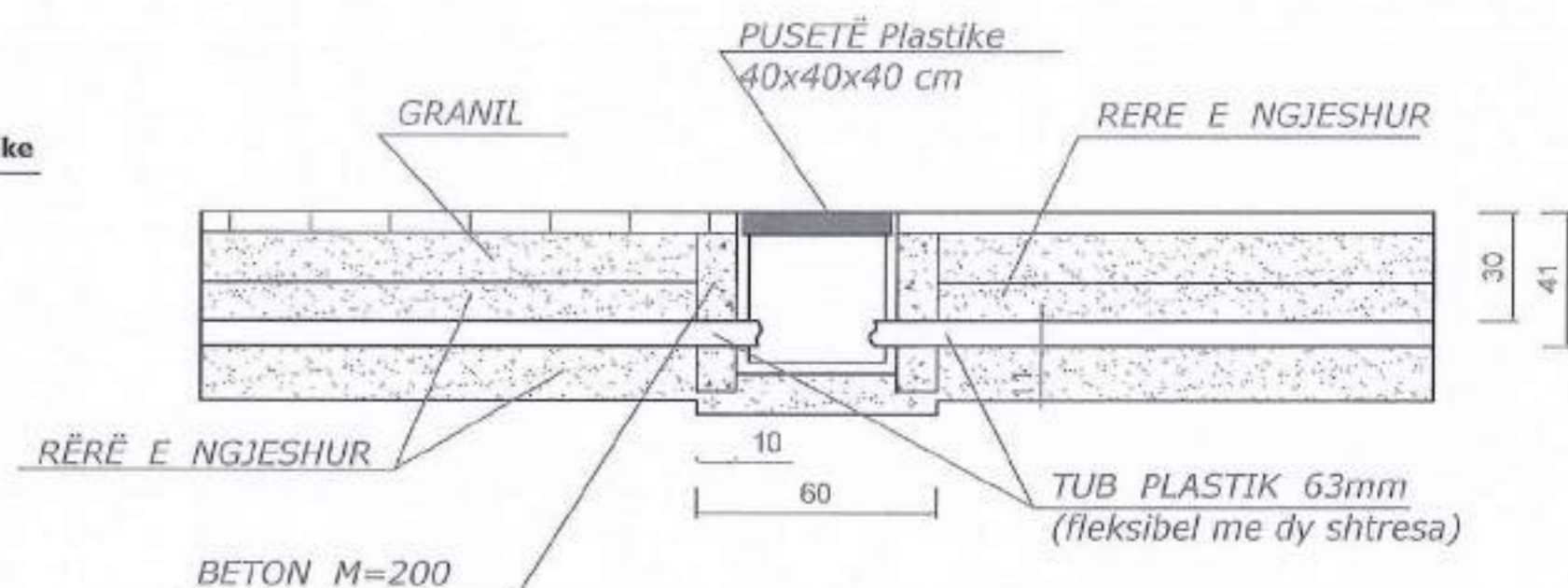

 NJESIA E PROJEKTIT DHE INFRASTRUKTURËS	OBJEKTI : REHABILITIM "RRUGA E DESHMOREVE", NGA KRYQEZIMI ME RRUGEN "MUJO ULQINAKU" TEK STACIONI TRENIT		
	TENDOSHIA : DURUES, DURUES	EMER MBEVET Ark. Orlan GRUÇKA Ark. Alba KOKOMANI Ingelek. Manglen JAVOLLARI Ark. Blanka MADHI	EMERTIMI I FLETES : DETAJE ELEKTRIKE
	PROJEKTI : ELEKTRIK	GRUPI PROJEKTIMIT :	DATA : 01/2025
	TARA E PROJEKTIT : PROJEKT ZBATIMI	No. I FLETES :	E105

BASHKIA DURRES



BASHKIA DURRES

OBJEKTI:

**REHABILITIM "RRUGA E DESHMOREVE", NGA KRYQEZIMI ME
RRUGEN "MUJO ULQINAKU" TEK STACIONI I TRENIT
(PROJEKT SINJALISTIKA RRUGORE)**



DURRES, 2020

NJESIA E PROEJKTIT DHE INFRASTRUKTURES

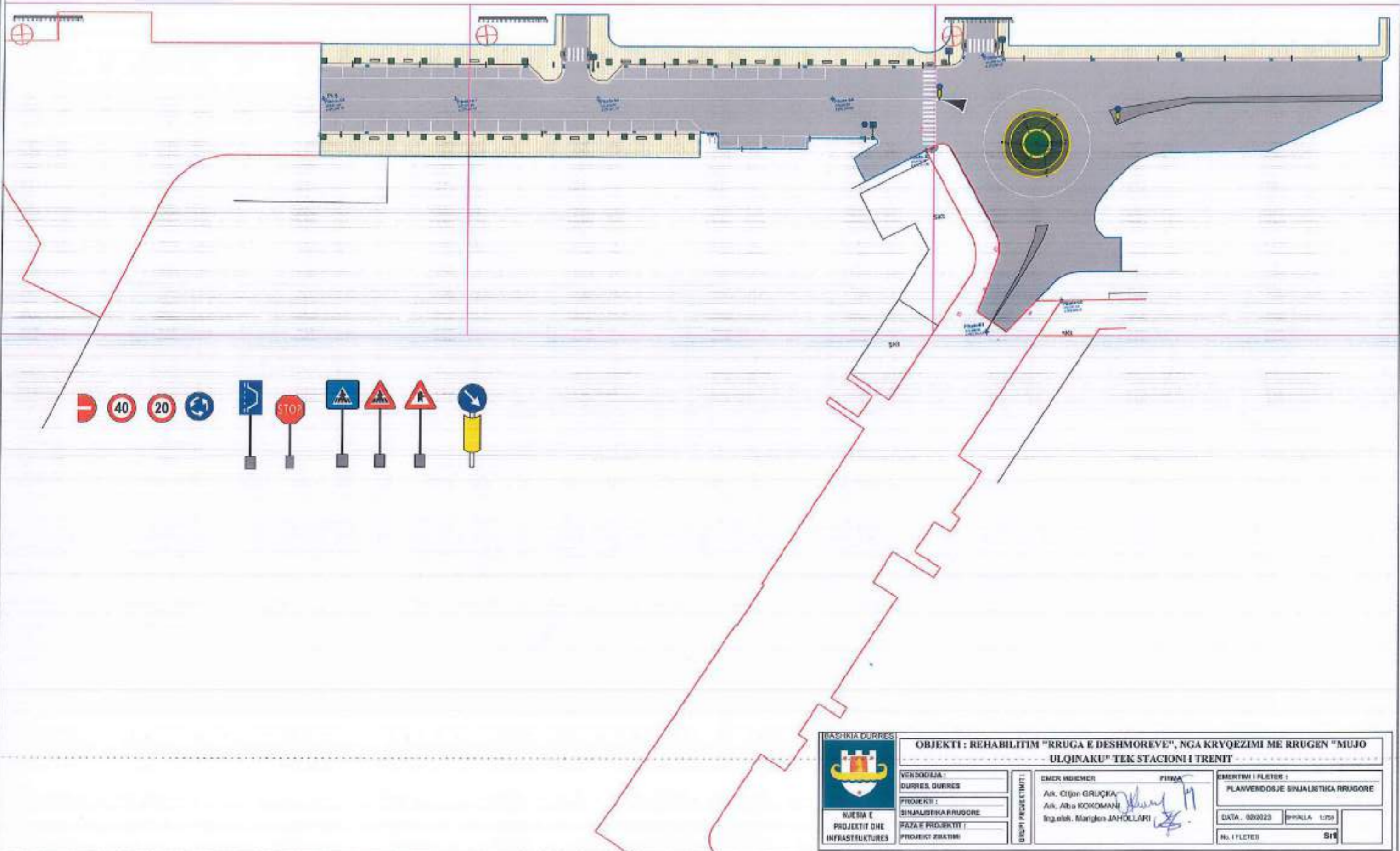

 NJESIA E PROJEKTI DHE INFRASTRUKTURES	OBJEKTI : REHABILITIM "RRUGA E DESHMOREVE", NGA KRYQEZIMI ME RRUGEN "MUJO ULQINAKU" TEK STACIONI I TRENIT		EMERTIMI I FLETES : PLANVENDOSJE SINJALISTIKA RRUGORE		
	VENDOSJEJA : DURRES, DURRES	EMER INDIEMER : Ark. Orlon GRUÇKA Ark. Alba KOKOMANI Ing.ark. Mariglen JAHOLLARI	FIRMA : 	DATA : 08/2023	SHALLA : 1:750
	PROJEKTI : SINJALISTIKA RRUGORE	UDHËSI PËRCAKTIMIT :	No. I FLETES :	No. I FLETES : Sir	
	FAZA E PROJEKTI : PROJEKTI ZBATIMI	No. I FLETES :	No. I FLETES :		



5Kt

Piketa-01
 370.483,95
 4.575.200,43

Piketa-02
 370.501,44
 4.575.205,53

Piketa-04
 370.488,42
 4.575.281,57

5Kt

 BASHKIA E DURRËS NJESIA E PROJEKTIT DHE INFRASTRUKTURËS	OBJEKTI : REHABILITIM "RRUGA E DESHMOREVE", NGA KRYQEZIMI ME RRUGEN "MUJO ULQINAKU" TEK STACIONI-TRENT		EMERTIVE I FLETES : PLANVENDOSJE SINJALISTIKA RRUGORE PIKETA 01- PIKETA 03		
	VENDOSJA : DURRES, DURRES	EMER BASHKIS Ark. Oltjen GRUÇKA	FIRMA  Ark. Alva KOKOMARI	DATA : 02/2023	SHKALLA : 1:250
	PROJEKTI : SINJALISTIKA RRUGORE	EMER PROJEKTIMIT : Ing. ekol. Marigjen JAHOLLARI		No I FLETES :	52
	FAZA E PROJEKTIT : PROJEKT ZBATIMI				

3

0 1 2 3 4 5 6 7 8 9 10 11 12 13 14 15



07
28
448



<p>MEMA E PROJEKTIT DHE INFRASTRUKTURËS</p>	<p>OBJEKTI : REHABILITIM "RRUGA E DESHMOREVE", NGA KRYQEZIMI ME RRUGEN "MUJO ULQINAKU" TEK STACIONI I TRENTI</p>		
	<p>VENDOSHA : DURRËS, DURRËS</p>	<p>EMER MBREWER FIRMA Ark. Orlin GRUÇKA Ark. Alba KOKOMANI Inj. elik. Mariglen JAHDELLARI</p>	<p>EMERTIMI I FLETËS : PLANVENDOSJE SINJALISTIKA RRUGORE PIKETA04- PIKETA 03</p>
	<p>PROJEKTI : SINJALISTIKA RRUGORE</p>		<p>DATA : 02/2023 SHKALLA : 1:250</p>
	<p>FAZA E PROJEKTIT : PROJEKT ZBATIM</p>		<p>No. I FLETËS : S13</p>

0 1 2 3 4 5 6 7 8 9 10 11 12 13 14 15

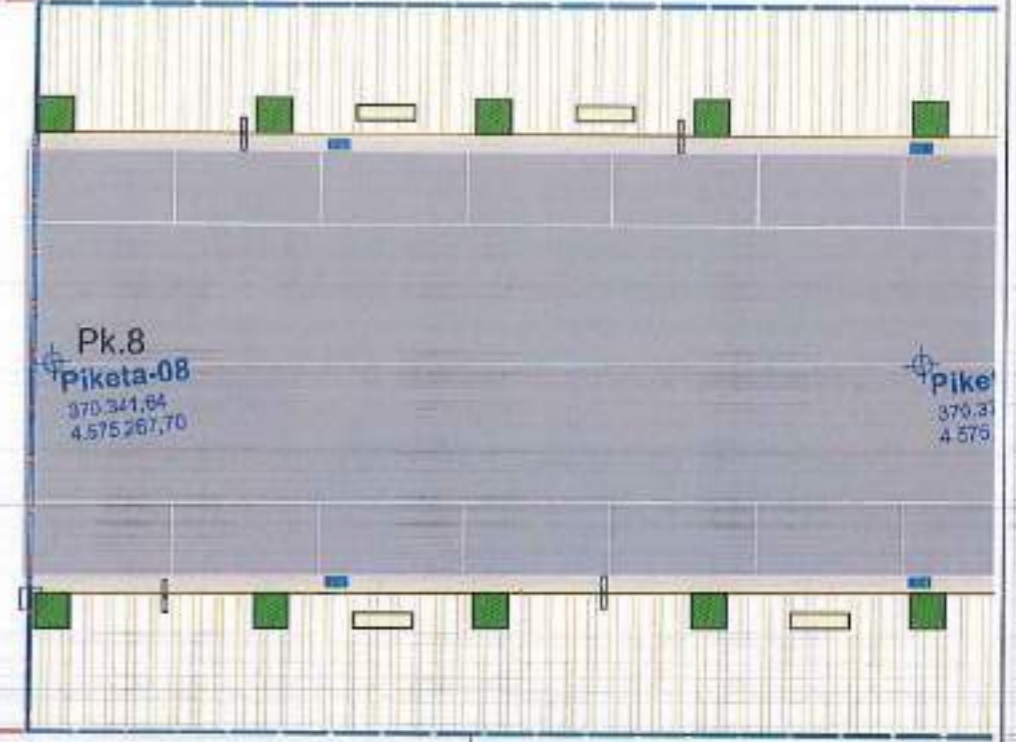

Pk.8
Piketa-08
370.341,84
4.575267,70

Piketa
370.31
4.575



 BASHKIA DURRES NJESIA E PROJEKTI DHE INFRASTRUKTURES	OBJEKTI : REHABILITIM "RRUGA E DESHMOREVE", NGA KRYQEZIMI ME RRUGEN "MUJO ULQINAKU" TEK STACIONI I TRENIT		EMERTIMI I FLETES : PLANVENDOSJE SINJALISTIKA RRUGORE PIKETA 01- PIKETA 03		
	VENDODHJA : DURRES, DURRES	EMER MBIMER Ark. Orijan GRUÇKA Ark. Alba KOKOMANI Ing. Enk. Mariglen JAHOLLARI	FIRMA : 	DATA : 002023	SHALLA : 0250
	PROJEKTI : SINJALISTIKA RRUGORE	GRUPI PROJEKTIMIT :	No. FLETES :	SHALLA :	SI4
	FAZA E PROJEKTI : PROJEKT ZBATIM	No. FLETES :	SHALLA :	SI4	SI4