



REPUBLIKA E SHQIPERISE
BASHKIA PATOS
DREJTORIA E PANIFIKIMIT URBAN, PROJEKTEVE, SHERBIMEVE DHE EMERGJENCAVE
CIVILE

OBJEKTI: RIKONSTRUKSION I RRUGES "LAGJJA E RE" TE PERROI ÇAM

PLANI I RILEVIMIT TOPOGRAFIK

Nr. i fleteve: 16 (gjashtembedhete) flete

Grupi i Projektimit:

Ing. Top. Marsilda KAMBERAJ

Drejtore :

Ing. Boreta MURATI

MIRATOHET
KRYETAR
FATION DURO

Korrik 2023

Rilevimi Topografik (ORTOFOTO)



Legjendë:

Mur Blloku	—
Sarthe	—
Rrugë	—
Bankina e perroi	—
Mur Betoni	—
Shkollë tensioni	●
Objekte te marra nga harta dantele	□
Objekte te rievuara	□
Sarthe gj	—
Pikë topografike (detaj)	●
Stacion topografik	●
Isops	—
Asfalt	—
Shkollë ndriçimi	●
Aksi egzistues	—
Pjesa territore	—
Fiber Optikë/Shkollë	—



REPUBLIKA E SHQIPERISE
BASHKIA PATOS
DREJTORIA E PLANIFIKIMIT URBAN,
PROJEKTEVE, SHERBIMEVE DHE
EMERGJENCAVE CIVILE

EMERTIMI I PROJEKTIT:

**RIKONSTRUKSION I
RRUGES "LAGJJA E RE"
TEK PERROI CAM**

EMERTIMI I FLETES:

Rilevimi Topografik (ortofoto)

GRUPI I PROJEKTIMIT:

Ing. Top **Marsilda Kamberaj**
Ing.
Ark.
Ing elek.

DREJTORIA E PLANIFIKIMIT
URBAN, PROJEKTEVE,
SHERBIMEVE DHE
EMERGJENCAVE CIVILE

Ing. Boreta Murati

SHKALLA

1:

Fleta: NR 1

KORRIK 2023

Rilevimi Topografik (Planimetria Fillestare)

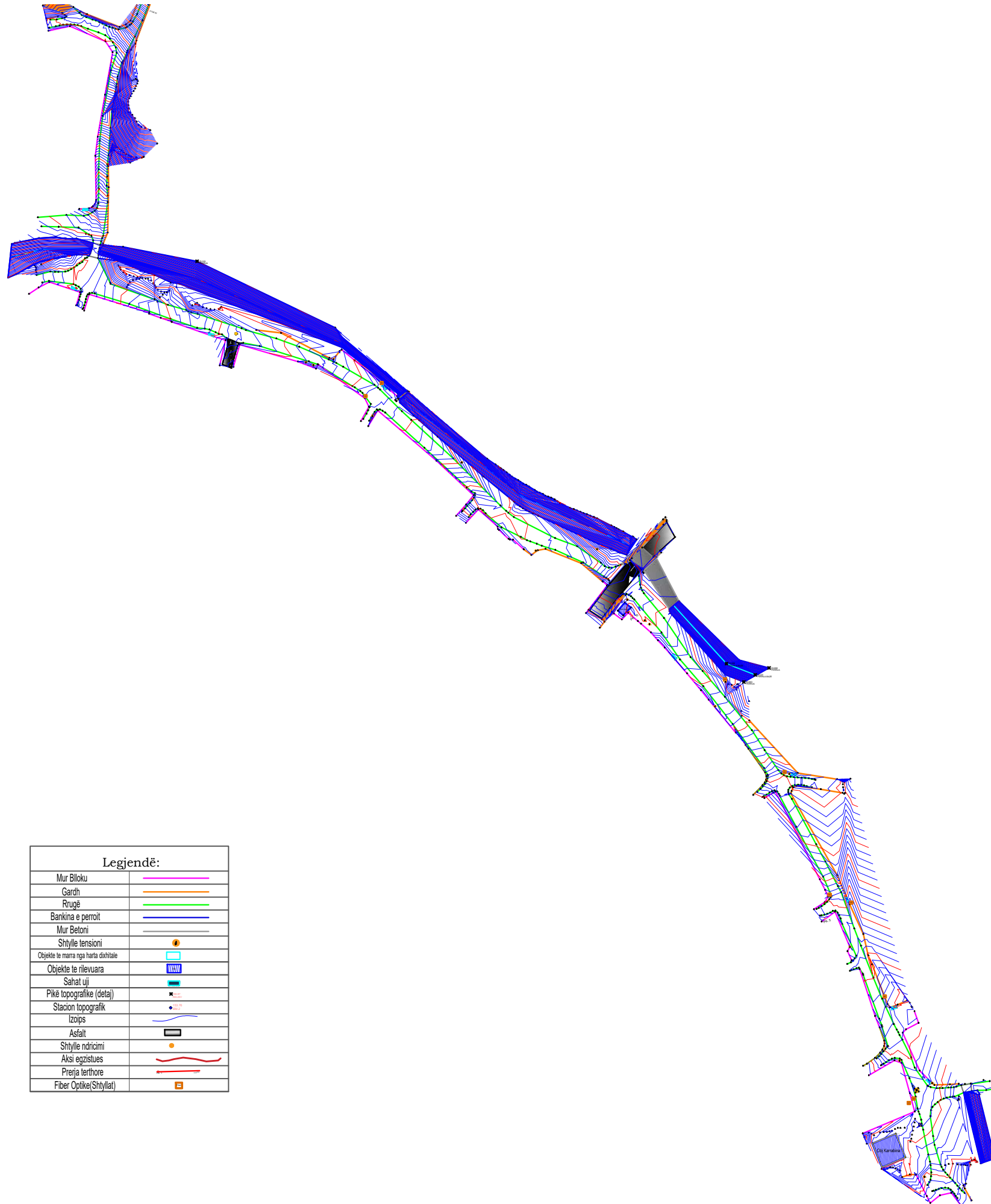

Legjendë:

Mur Blloku	—
Gardh	—
Rrugë	—
Bankina e perroit	—
Mur Betoni	—
Shtyllë tensioni	●
Objekte të marra nga harta diahtale	□
Objekte të rievuara	□
Sahat uji	■
Pikë topografike (detaj)	★
Stacion topografik	●
Izoips	—
Asfalt	■
Shtyllë ndricimi	●
Aksi egzistues	—
Prejja terthore	—
Fiber Optike(Shtyllat)	■



REPUBLIKA E SHQIPERISE
BASHKIA PATOS
DREJTORIA E PLANIFIKIMIT URBAN,
PROJEKTEVE, SHERBIMEVE DHE
EMERGJENCAVE CIVILE

EMERTIMI I PROJEKTIT:

**RIKONSTRUKSION I
RRUGES "LAGJJA E RE"
TEK PERROI CAM**

EMERTIMI I FLETES:

Rilevimi Topografik
(PLANIMETRIA FILLESTARE)

GRUPI I PROJEKTIMIT:

Ing. Top **Marsilda Kamberaj**

Ing.

Ark.

Ing elek.

DREJTORIA E PLANIFIKIMIT
URBAN, PROJEKTEVE,
SHERBIMEVE DHE
EMERGJENCAVE CIVILE

Ing. Boreta Murati

SHKALLA

1:

Fleta: NR 2

KORRIK 2023

Rilevimi Topografik (ME IZOIPSE)

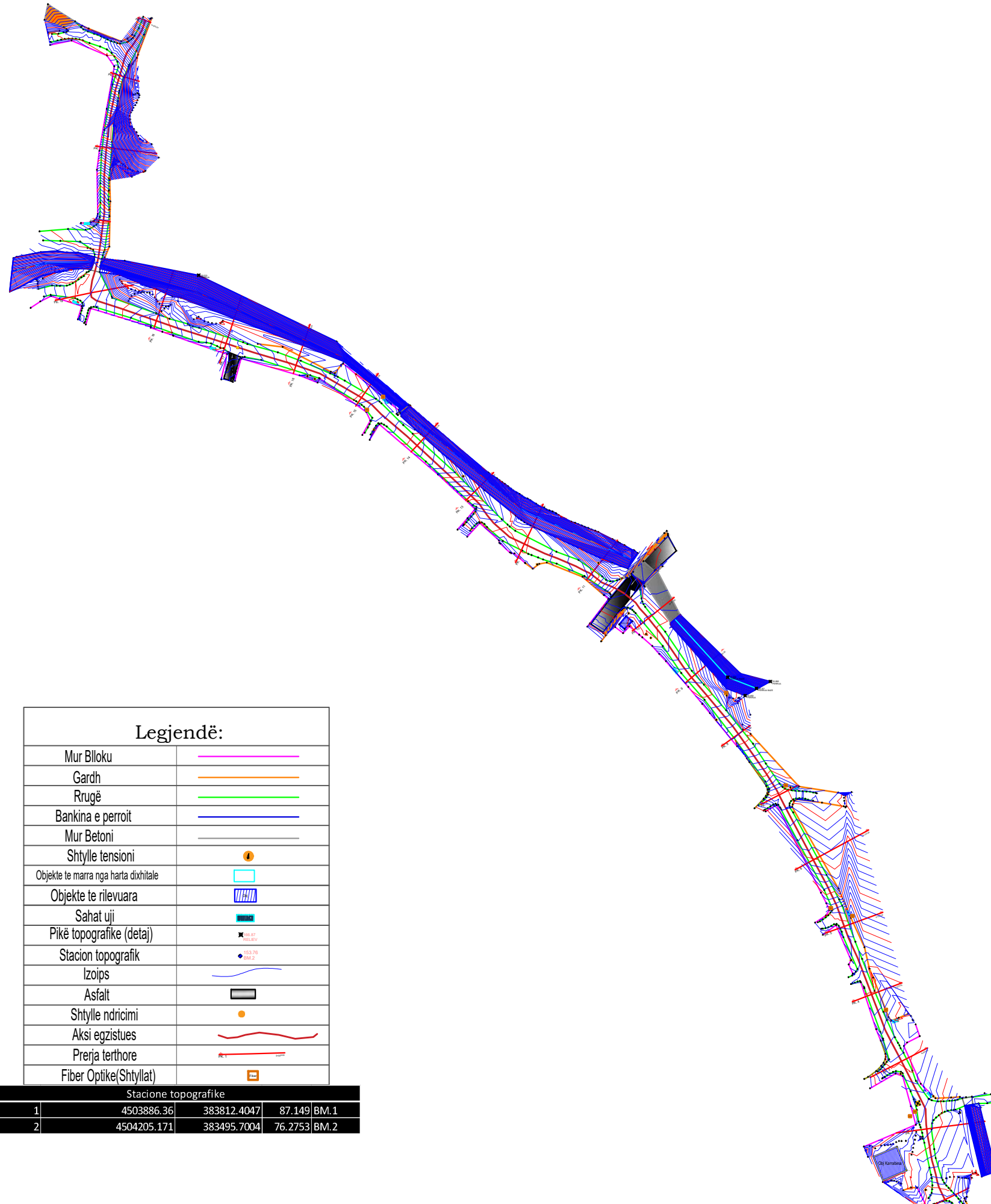

Legjendë:

Mur Blloku	
Gardh	
Rrugë	
Bankina e perroit	
Mur Betoni	
Shtylle tensioni	
Objekte te marra nga harta dixhitale	
Objekte te rlevuara	
Sahat uji	
Pikë topografike (detaj)	
Stacion topografik	
Izoips	
Asfalt	
Shtylle ndricimi	
Aksi egzistues	
Preerja terthore	
Fiber Optike(Shtyllat)	

Stacione topografike			
1	4503886.36	383812.4047	87.149 BM.1
2	4504205.171	383495.7004	76.2753 BM.2



REPUBLIKA E SHQIPERISE
BASHKIA PATOS
DREJTORIA E PLANIFIKIMIT URBAN,
PROJEKTEVE, SHERBIMEVE DHE
EMERGJENCAVE CIVILE

EMERTIMI I PROJEKTIT:

**RIKONSTRUKSION I
RRUGES "LAGJJA E RE"
TEK PERROI CAM**

EMERTIMI I FLETES:

Rilevimi Topografik
(ME IZOIPSE)

GRUPI I PROJEKTIMIT:

Ing. Top **Marsilda Kamberaj**

Ing.

Ark.

Ing elek.

DREJTORIA E PLANIFIKIMIT
URBAN, PROJEKTEVE,
SHERBIMEVE DHE
EMERGJENCAVE CIVILE

Ing. Boreta Murati

SHKALLA

1:

Fleta: NR 3

KORRIK 2023

Rilevimi Topografik me izoipse Pk.1-Pk.3

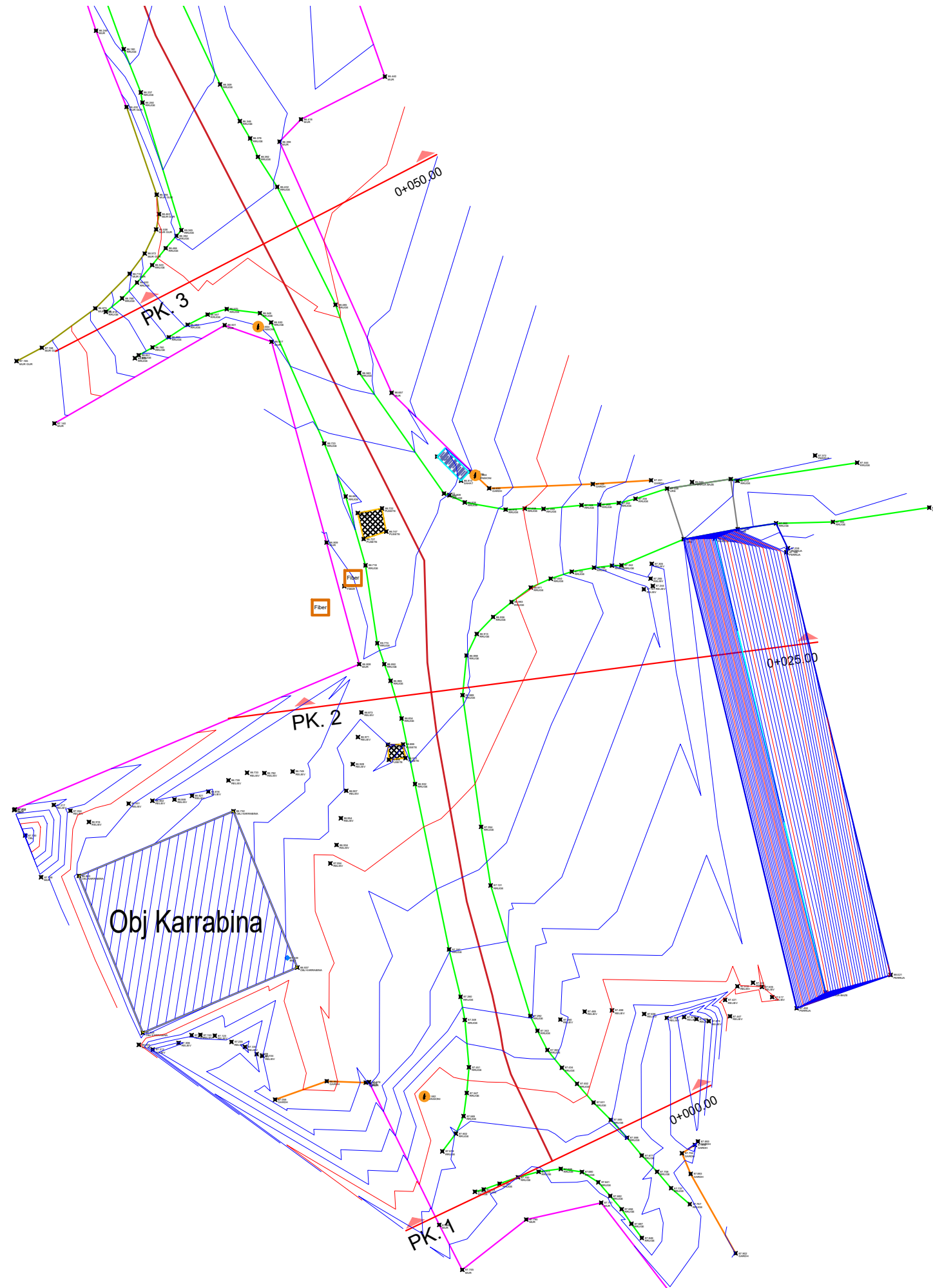

REPUBLIKA E SHQIPERISE
BASHKIA PATOS
DREJTORIA E PLANIFIKIMIT URBAN,
PROJEKTEVE, SHERBIMEVE DHE
EMERGJENCAVE CIVILE

EMERTIMI I PROJEKTIT:

**RIKONSTRUKSION I
RRUGES "LAGJJA E RE"
TEK PERROI CAM**

EMERTIMI I FLETES:

Rilevimi Topografik me
izoipse Pk.1-Pk.3

GRUPI I PROJEKTIMIT:

Ing. Top Marsilda Kamberaj

Ing.

Ark.

Ing elek.

DREJTORIA E PLANIFIKIMIT
URBAN, PROJEKTEVE,
SHERBIMEVE DHE
EMERGJENCAVE CIVILE

Ing. Boreta Murati

SHKALLA

1:2500

Fleta: NR 4

KORRIK 2023

Rilevimi Topografik me izoipse Pk.4-Pk.6

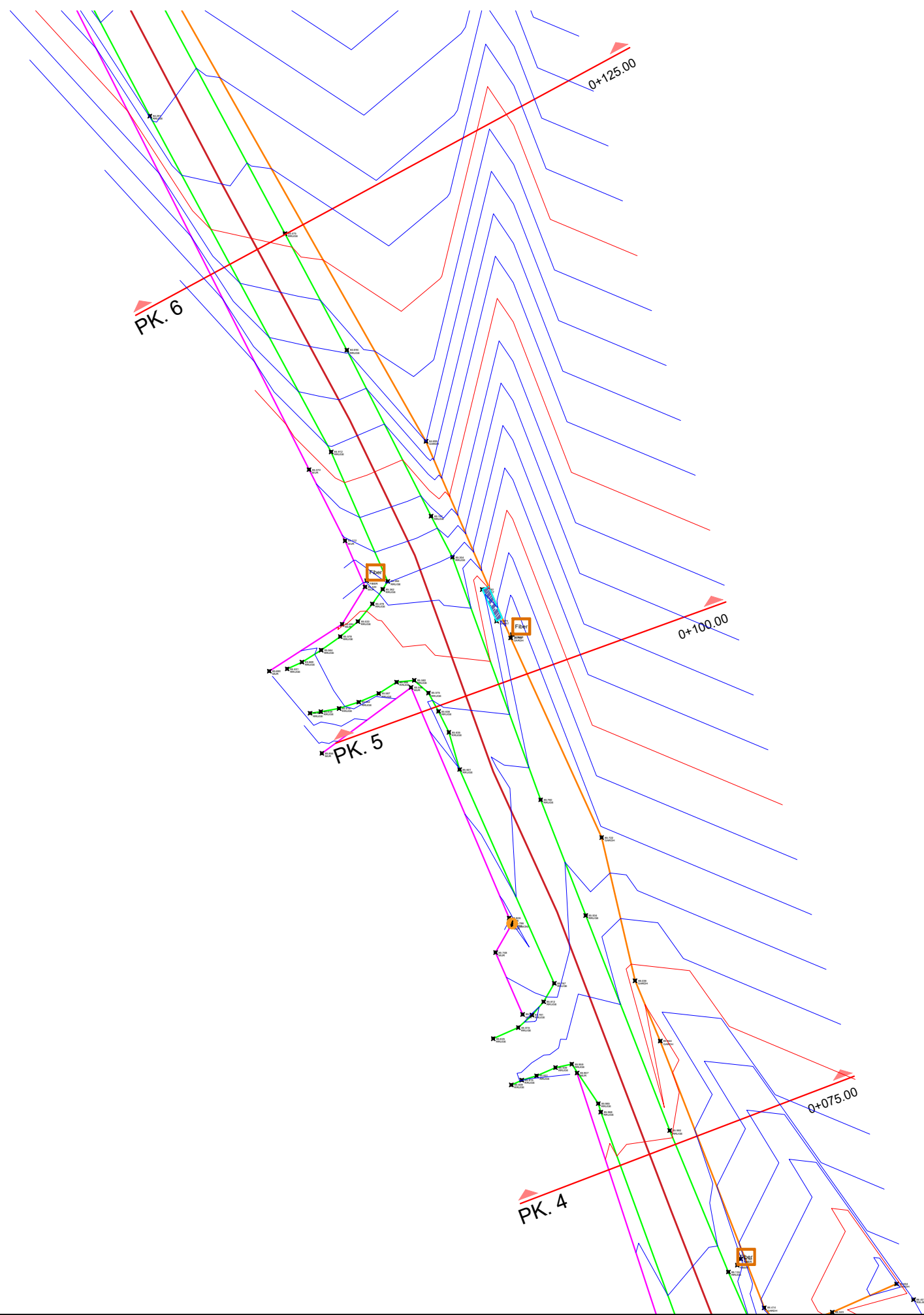

REPUBLIKA E SHQIPERISE
BASHKIA PATOS
DREJTORIA E PLANIFIKIMIT URBAN,
PROJEKTEVE, SHERBIMEVE DHE
EMERGJENCAVE CIVILE

EMERTIMI I PROJEKTIT:

**RIKONSTRUKSION I
RRUGES "LAGJJA E RE"
TEK PERROI CAM**

EMERTIMI I FLETES:

Rilevimi Topografik me
izoipse Pk.4-Pk.6

GRUPI I PROJEKTIMIT:

Ing. Top **Marsilda Kamberaj**

Ing.

Ark.

Ing elek.

DREJTORIA E PLANIFIKIMIT
URBAN, PROJEKTEVE,
SHERBIMEVE DHE
EMERGJENCAVE CIVILE

Ing. Boreta Murati

SHKALLA

1:2500

Fleta: NR 5

KORRIK 2023

Rilevimi Topografik me izoipse Pk.7-Pk.10

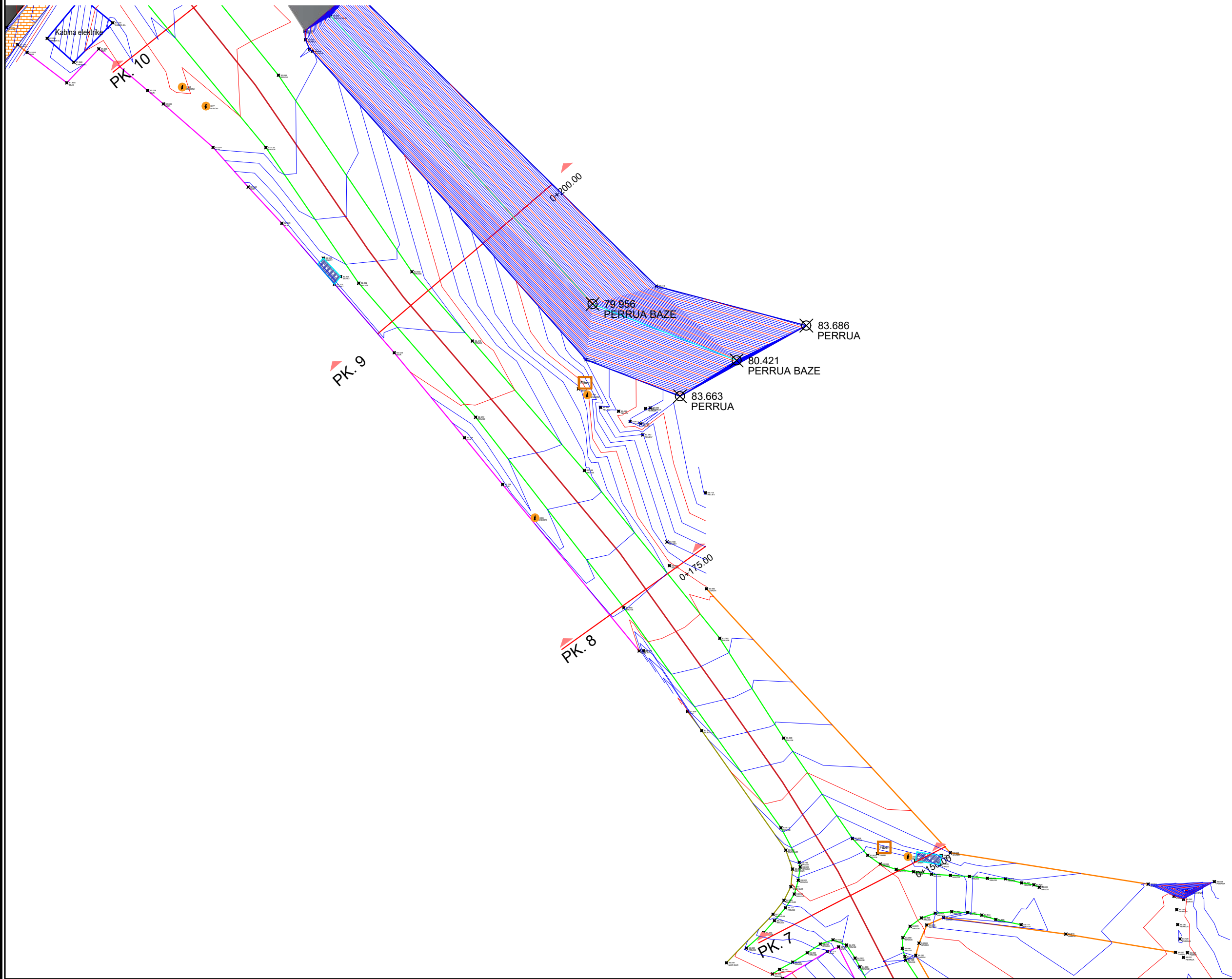

REPUBLIKA E SHQIPERISE
BASHKIA PATOS
DREJTORIA E PLANIFIKIMIT URBAN,
PROJEKTEVE, SHERBIMEVE DHE
EMERGJENCAVE CIVILE

EMERTIMI I PROJEKTIT:

**RIKONSTRUKSION I
RRUGES "LAGJJA E RE"
TEK PERROI CAM**

EMERTIMI I FLETES:

Rilevimi Topografik me
izoipse Pk.7-Pk.10

GRUPI I PROJEKTIMIT:

Ing. Top **Marsilda Kamberaj**

Ing.

Ark.

Ing elek.

DREJTORIA E PLANIFIKIMIT
URBAN, PROJEKTEVE,
SHERBIMEVE DHE
EMERGJENCAVE CIVILE

Ing. Boreta Murati

SHKALLA

1:2500

Fleta: NR 6

KORRIK 2023

Rilevimi Topografik me izoipse Pk.10-Pk.13



REPUBLIKA E SHQIPERISE
BASHKIA PATOS
DREJTORIA E PLANIFIKIMIT URBAN,
PROJEKTEVE, SHERBIMEVE DHE
EMERGJENCAVE CIVILE

EMERTIMI I PROJEKTIT:

**RIKONSTRUKSION I
RRUGES "LAGJJA E RE"
TEK PERROI CAM**

EMERTIMI I FLETES:

Rilevimi Topografik me
izoipse Pk.10-Pk.13

GRUPI I PROJEKTIMIT:

Ing. Top **Marsilda Kamberaj**

Ing.

Ark.

Ing elek.

DREJTORIA E PLANIFIKIMIT
URBAN, PROJEKTEVE,
SHERBIMEVE DHE
EMERGJENCAVE CIVILE

Ing. Boreta Murati

SHKALLA

1:2500

Fleta: NR 7

KORRIK 2023

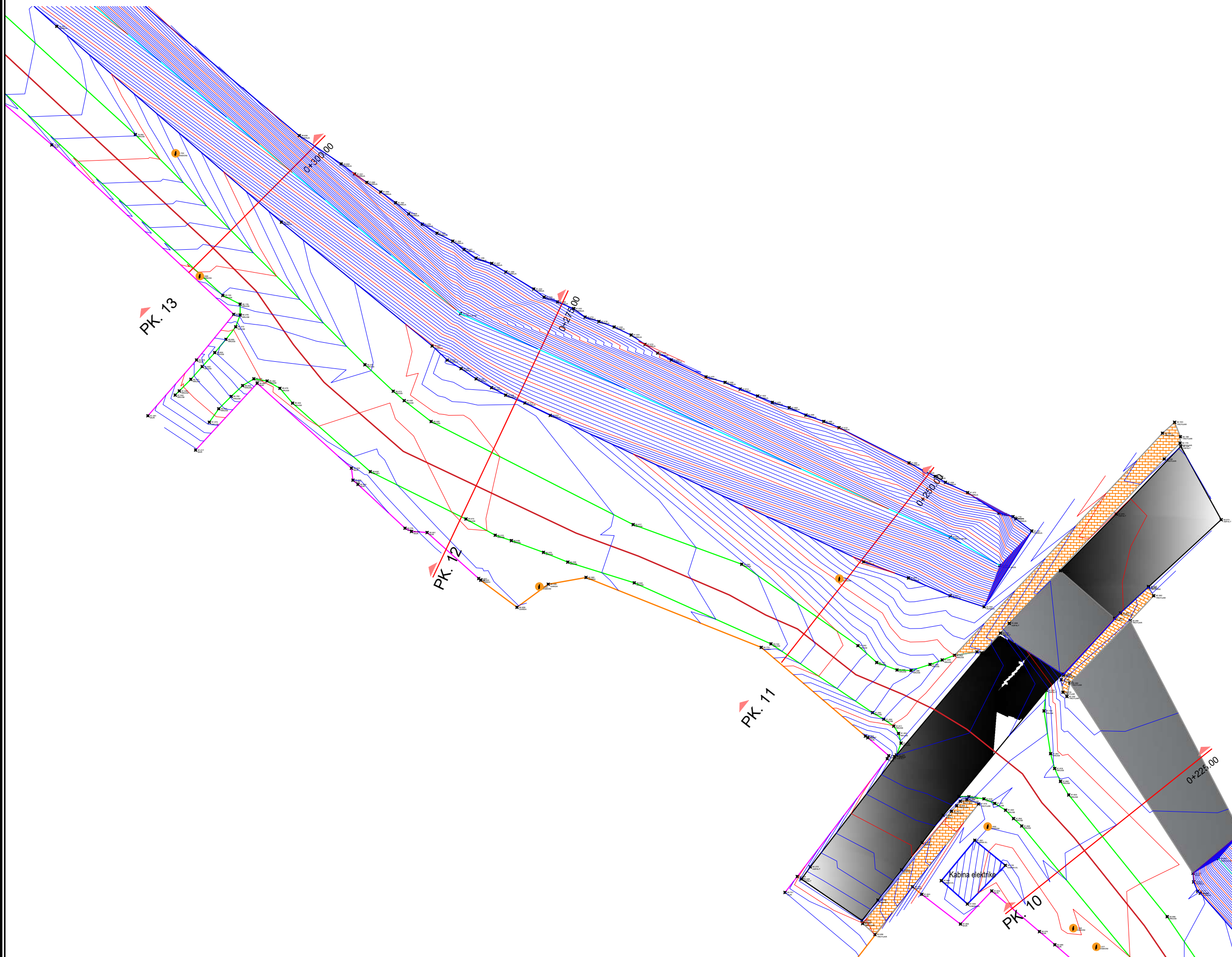

Rilevimi Topografik me izoipse Pk.13-Pk.16

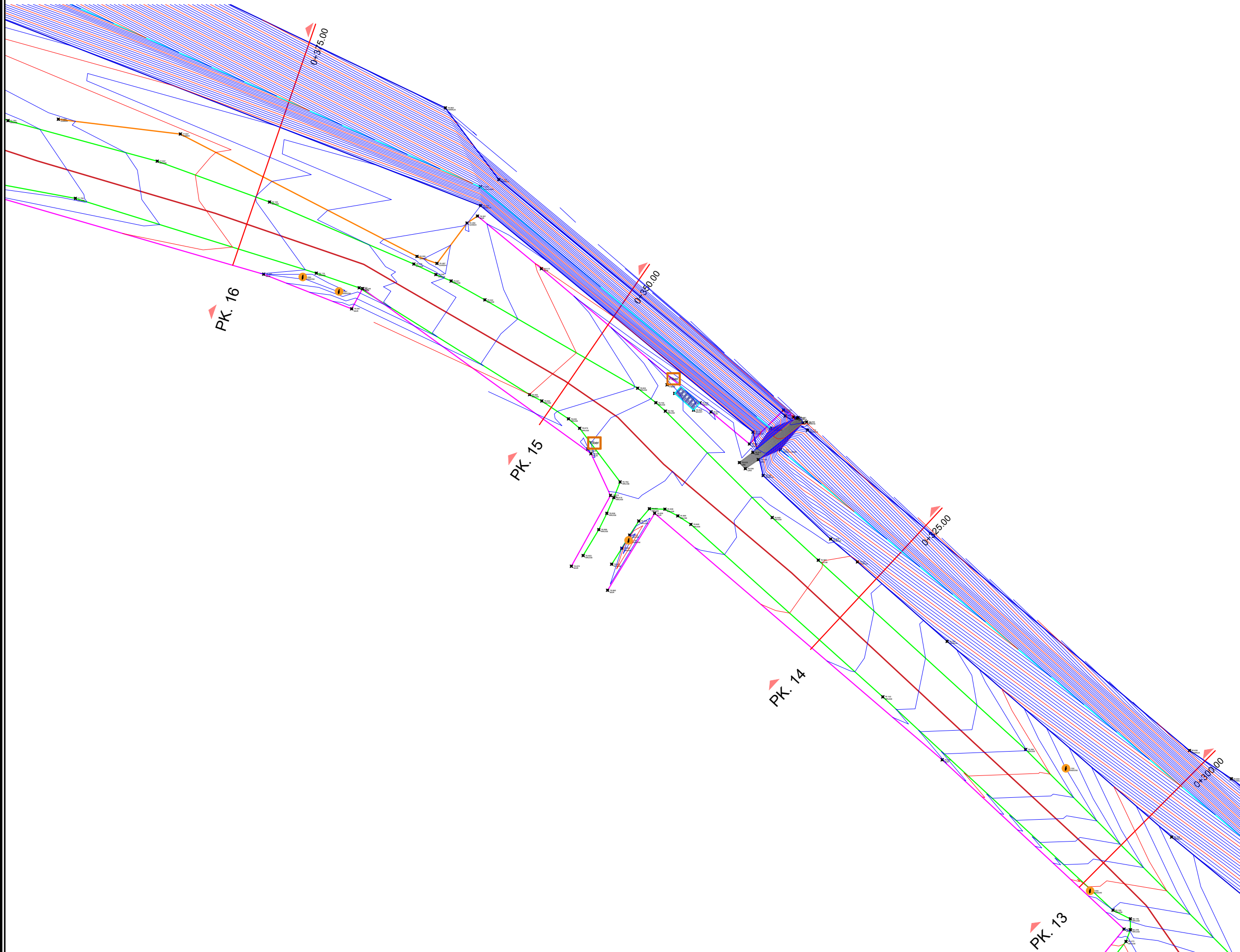

REPUBLIKA E SHQIPERISE
BASHKIA PATOS
DREJTORIA E PLANIFIKIMIT URBAN,
PROJEKTEVE, SHERBIMEVE DHE
EMERGJENCAVE CIVILE

EMERTIMI I PROJEKTIT:

**RIKONSTRUKSION I
RRUGES "LAGJJA E RE"
TEK PERROI CAM**

EMERTIMI I FLETES:

Rilevimi Topografik me
izoipse Pk.13-Pk.16

GRUPI I PROJEKTIMIT:

Ing. Top **Marsilda Kamberaj**
Ing.
Ark.
Ing elek.

DREJTORIA E PLANIFIKIMIT
URBAN, PROJEKTEVE,
SHERBIMEVE DHE
EMERGJENCAVE CIVILE

Ing. Boreta Murati

SHKALLA

1:2500

Fleta: NR 8

KORRIK 2023

Rilevimi Topografik me izoipse Pk.16-Pk.20

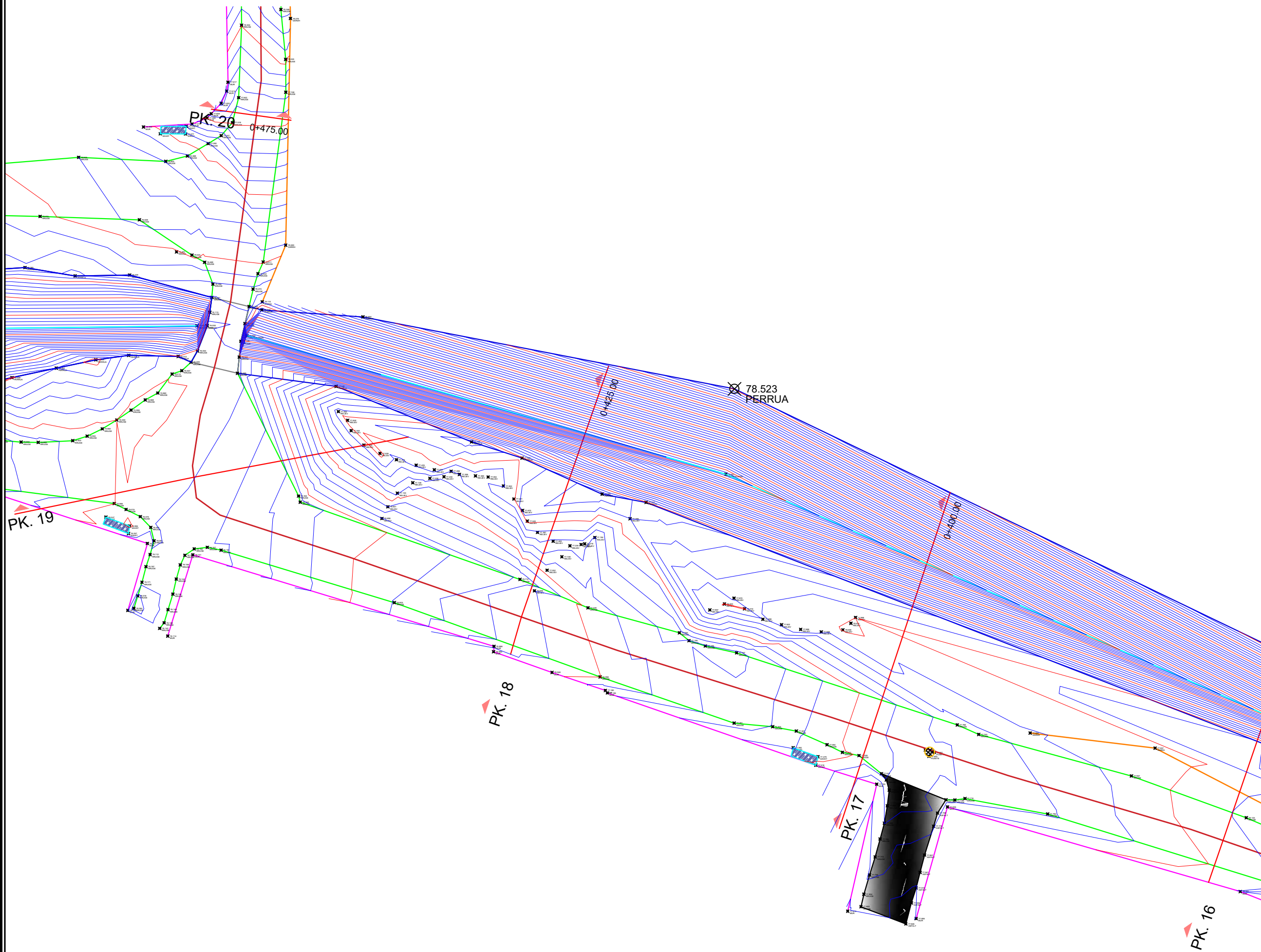

REPUBLIKA E SHQIPERISE
BASHKIA PATOS
DREJTORIA E PLANIFIKIMIT URBAN,
PROJEKTEVE, SHERBIMEVE DHE
EMERGJENCAVE CIVILE

EMERTIMI I PROJEKTIT:

**RIKONSTRUKSION I
RRUGES "LAGJJA E RE"
TEK PERROI CAM**

EMERTIMI I FLETES:

Rilevimi Topografik me
izoipse Pk.16-Pk.20

GRUPI I PROJEKTIMIT:

Ing. Top **Marsilda Kamberaj**

Ing.

Ark.

Ing elek.

DREJTORIA E PLANIFIKIMIT
URBAN, PROJEKTEVE,
SHERBIMEVE DHE
EMERGJENCAVE CIVILE

Ing. Boreta Murati

SHKALLA

1:2500

Fleta: NR 9

KORRIK 2023

Rilevimi Topografik me izoipse Pk.20-Pk.23

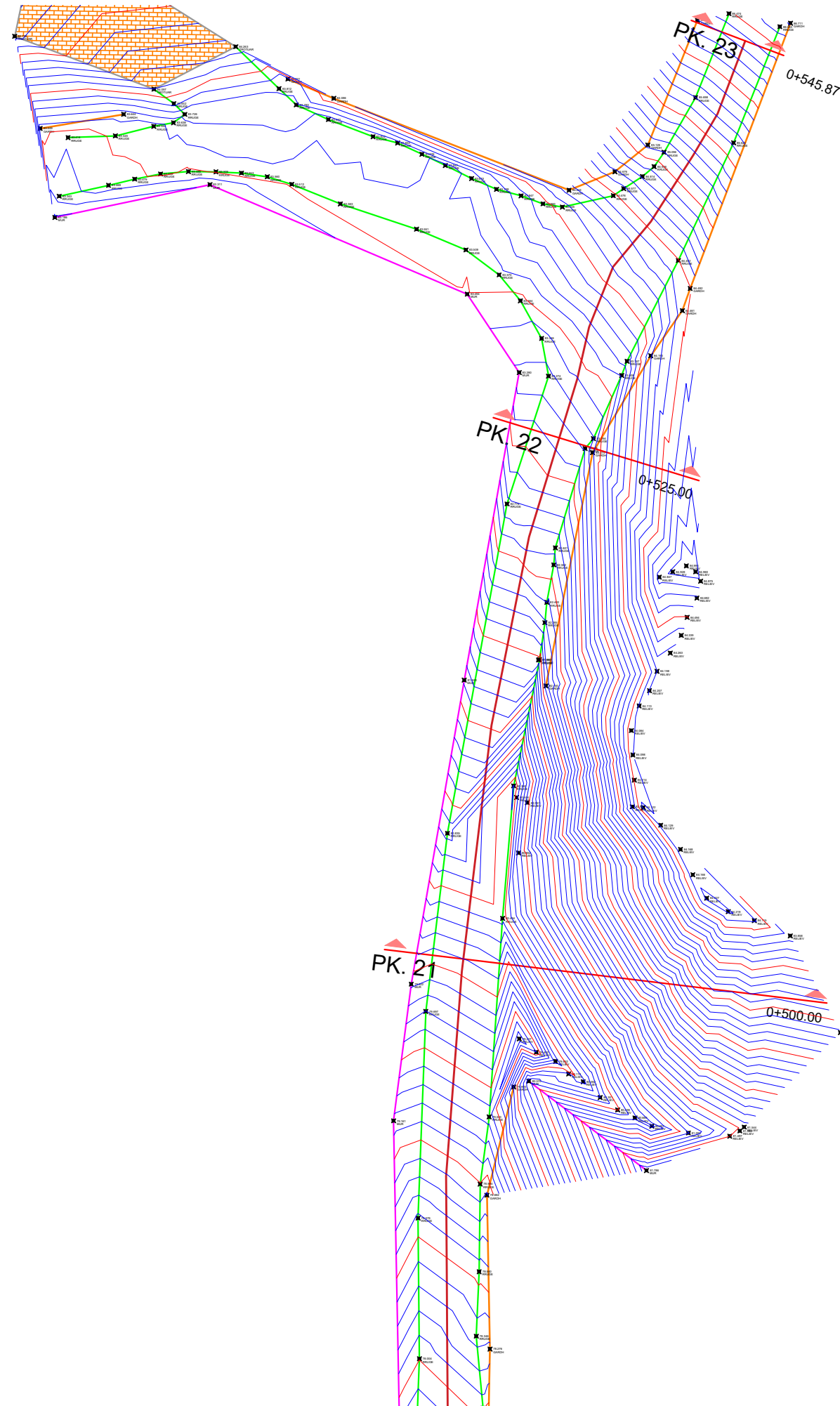

REPUBLIKA E SHQIPERISE
BASHKIA PATOS
DREJTORIA E PLANIFIKIMIT URBAN,
PROJEKTEVE, SHERBIMEVE DHE
EMERGJENCAVE CIVILE

EMERTIMI I PROJEKTIT:

**RIKONSTRUKSION I
RRUGES "LAGJJA E RE"
TEK PERROI CAM**

EMERTIMI I FLETES:

Rilevimi Topografik me
izoipse Pk.20-Pk.23

GRUPI I PROJEKTIMIT:

Ing. Top **Marsilda Kamberaj**

Ing.

Ark.

Ing elek.

DREJTORIA E PLANIFIKIMIT
URBAN, PROJEKTEVE,
SHERBIMEVE DHE
EMERGJENCAVE CIVILE

Ing. Boreta Murati

SHKALLA

1:2500

Fleta: NR 10

KORRIK 2023

Rilevimi Topografik (PROFILI GJATESOR) Pk.1-Pk.8



REPUBLIKA E SHQIPERISE
BASHKIA PATOS
DREJTORIA E PLANIFIKIMIT URBAN,
PROJEKTEVE, SHERBIMEVE DHE
EMERGJENCAVE CIVILE

EMERTIMI I PROJEKTIT:

**RIKONSTRUKSION I
RRUGES "LAGJJA E RE"
TEK PERROI CAM**

EMERTIMI I FLETES:

Rilevimi Topografik
PROFILI GJATESOR
Pk.1-Pk.8

GRUPI I PROJEKTIMIT:

Ing. Top **Marsilda Kamberaj**

Ing.

Ark.

Ing elek.

DREJTORIA E PLANIFIKIMIT
URBAN, PROJEKTEVE,
SHERBIMEVE DHE
EMERGJENCAVE CIVILE

Ing. Boreta Murati

SHKALLA

1:

Fleta: NR 11

KORRIK 2023

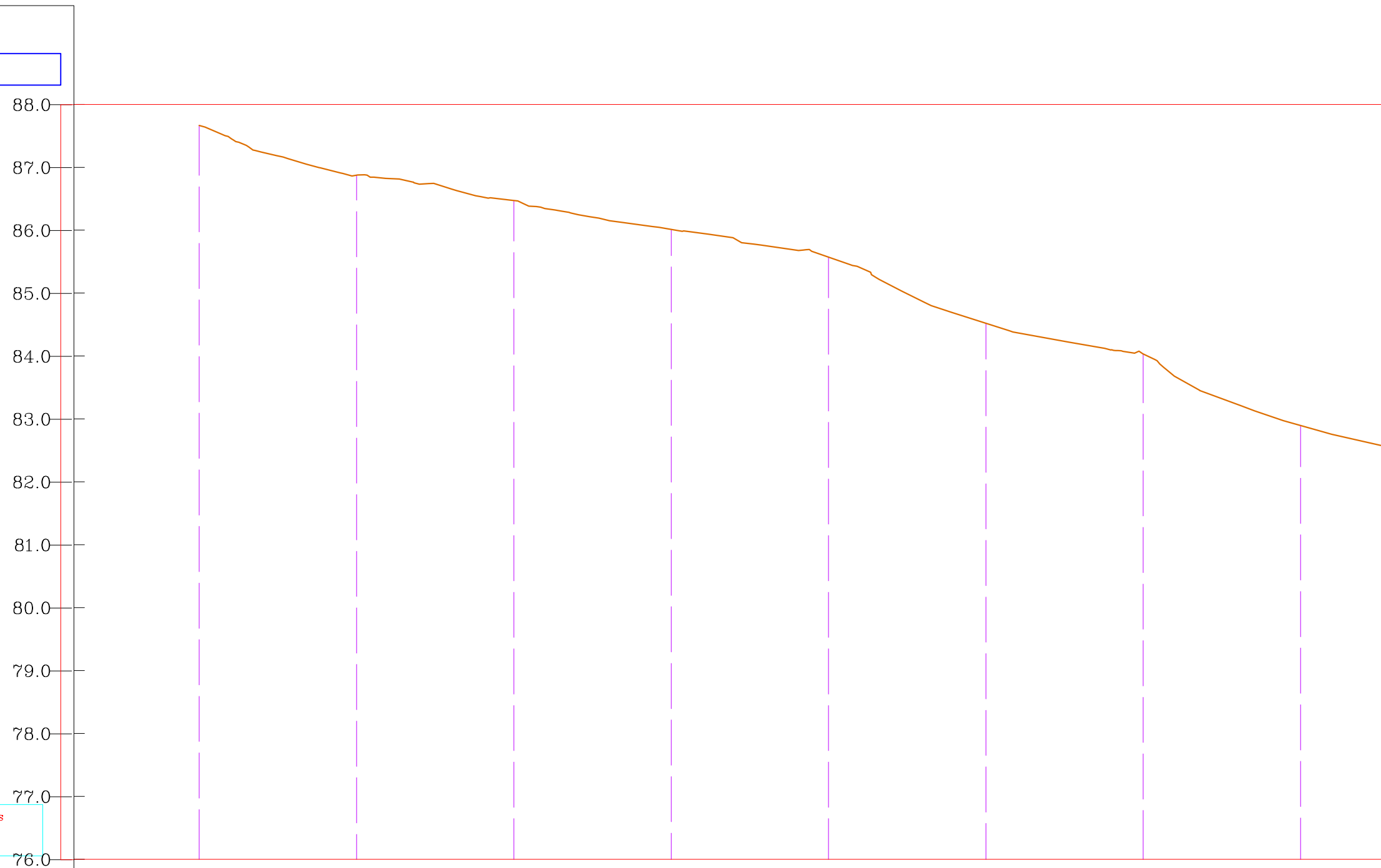

DISTANCA PJESORE	25,00	25,00	25,00	25,00	25,00	25,00	25,00	25,00
DISTANCA PROGRESIVE	0+000.00	0+025.00	0+050.00	0+075.00	0+100.00	0+125.00	0+150.00	0+175.00
NUMERI PROFILEVE	Sc-1	Sc-2	Sc-3	Sc-4	Sc-5	Sc-6	Sc-7	Sc-8
KUOTA E TERRENIT	87.66	86.88	86.47	86.01	85.57	84.52	84.03	82.90
KILOMETRAZHI	0				01			

Rilevimi Topografik (PROFILI GJATESOR) Pk.9-Pk.17



REPUBLIKA E SHQIPERISE
BASHKIA PATOS
DREJTORIA E PLANIFIKIMIT URBAN,
PROJEKTEVE, SHERBIMEVE DHE
EMERGJENCAVE CIVILE

EMERTIMI I PROJEKTIT:

**RIKONSTRUKSION I
RRUGES "LAGJJA E RE"
TEK PERROI CAM**

EMERTIMI I FLETES:

Rilevimi Topografik
PROFILI GJATESOR
Pk.9-Pk.17

GRUPI I PROJEKTIMIT:

Ing. Top **Marsilda Kamberaj**
Ing.
Ark.
Ing elek.

DREJTORIA E PLANIFIKIMIT
URBAN, PROJEKTEVE,
SHERBIMEVE DHE
EMERGJENCAVE CIVILE

Ing. Boreta Murati

SHKALLA

Fleta: NR 12

1:

KORRIK 2023

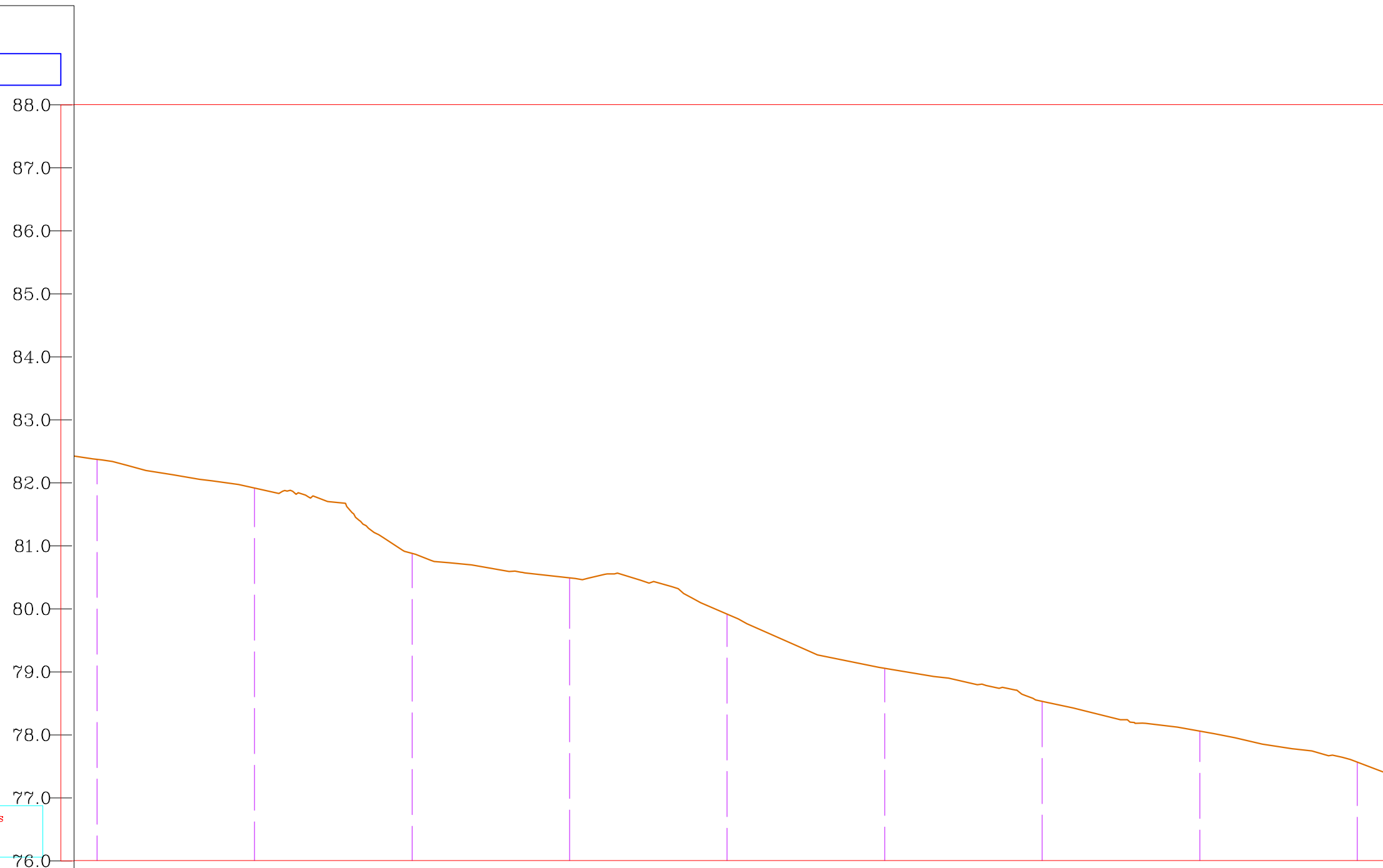

DISTANCA PJESORE	25,00	25,00	25,00	25,00	25,00	25,00	25,00	25,00	25,00
DISTANCA PROGRESIVE	0+200.00	0+225.00	0+250.00	0+275.00	0+300.00	0+325.00	0+350.00	0+375.00	0+400.00
NUMERI PROFILEVE	Sc-9	Sc-10	Sc-11	Sc-12	Sc-13	Sc-14	Sc-15	Sc-16	Sc-17
KUOTA E TERRENIT	82.37	81.91	80.88	80.49	79.91	79.05	78.53	78.05	77.56
KILOMETRAZHI	0	0.25	0.50	0.75	1.00	1.25	1.50	1.75	2.00

Rilevimi Topografik (PROFILI GJATESOR) Pk.17-Pk.23



REPUBLIKA E SHQIPERISE
BASHKIA PATOS
DREJTORIA E PLANIFIKIMIT URBAN,
PROJEKTEVE, SHERBIMEVE DHE
EMERGJENCAVE CIVILE

EMERTIMI I PROJEKTIT:

**RIKONSTRUKSION I
RRUGES "LAGJJA E RE"
TEK PERROI CAM**

EMERTIMI I FLETES:

Rilevimi Topografik
PROFILI GJATESOR
Pk.17-Pk.23

GRUPI I PROJEKTIMIT:

Ing. Top **Marsilda Kamberaj**

Ing.

Ark.

Ing elek.

DREJTORIA E PLANIFIKIMIT
URBAN, PROJEKTEVE,
SHERBIMEVE DHE
EMERGJENCAVE CIVILE

Ing. Boreta Murati

SHKALLA

1:

Fleta: NR 13

KORRIK 2023

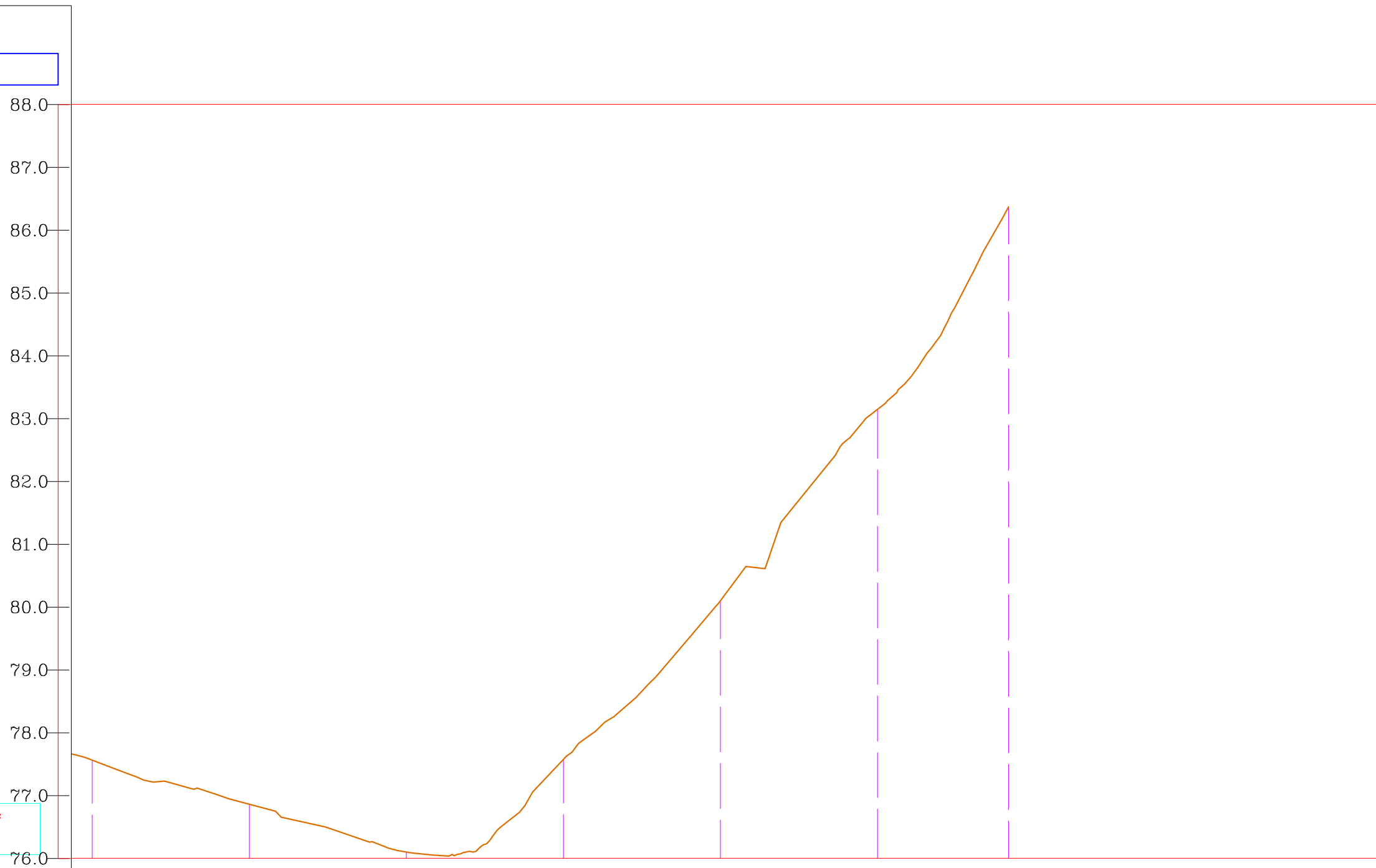

Profili : Profili gjatesor i rrugës
Shkalla : 250:25
Kuota Ref : 76.00

DISTANCA PJESORE	25,00	25,00	25,00	25,00	25,00	20,87	
DISTANCA PROGRESIVE	Sc-17 0+400.00	Sc-18 0+425.00	Sc-19 0+450.00	Sc-20 0+475.00	Sc-21 0+500.00	Sc-22 0+525.00	Sc-23 0+545.87
NUMERI PROFILEVE	Sc-17	Sc-18	Sc-19	Sc-20	Sc-21	Sc-22	Sc-23
KUOTA E TERRENIT	77.56	76.86	76.10	77.57	80.10	83.15	86.37
KILOMETRAZHI	00	04			05		06

Rilevimi Topografik (Profilet terthore) Pk.1-Pk12



REPUBLIKA E SHQIPERISE
BASHKIA PATOS
DREJTORIA E PLANIFIKIMIT URBAN,
PROJEKTEVE, SHERBIMEVE DHE
EMERGJENCAVE CIVILE

EMERTIMI I PROJEKTIT:

**RIKONSTRUKSION I
RRUGES "LAGJJA E RE"
TEK PERROI CAM**

EMERTIMI I FLETES:

Rilevimi Topografik
PROFILET TERTHORE
Pk.1-PK.12

GRUPI I PROJEKTIMIT:

Ing. Top Marsilda Kamberaj

Ing.

Ark.

Ing elek.

DREJTORIA E PLANIFIKIMIT
URBAN, PROJEKTEVE,
SHERBIMEVE DHE
EMERGJENCAVE CIVILE

Ing. Boreta Murati

SHKALLA

1:

Fleta: NR 14

KORRIK 2023

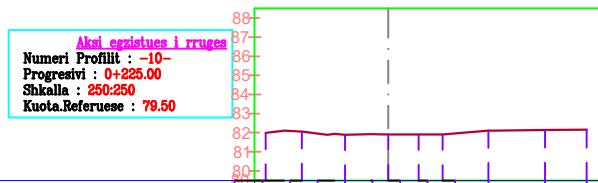

DIST.PROGRES.TERENIT	-6.41	-5.45	-4.52	-2.82	-2.27	-0.90	0.00	1.59	2.85	5.23	8.20	10.38
KUOTA E TERRENIT	82.00	82.10	82.06	81.93	81.89	81.92	81.91	81.91	81.90	82.11	82.14	82.15

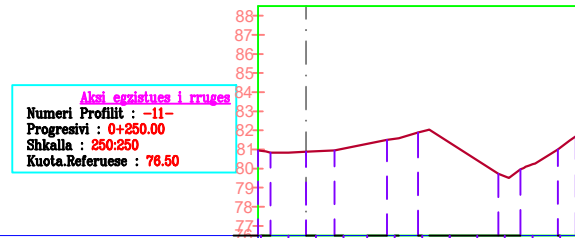

DIST.PROGRES.TERENIT	-0.92	0.00	1.49	4.24	4.86	5.86	10.86	10.63	11.23	11.86	13.19	13.81
KUOTA E TERRENIT	80.83	80.88	80.95	81.49	81.59	81.89	82.08	79.51	79.95	80.23	80.99	81.47

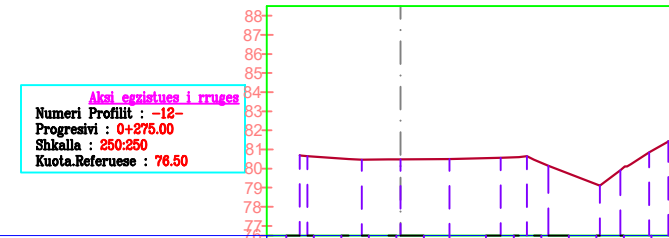

DIST.PROGRES.TERENIT	-5.28	-4.88	-2.73	-2.04	-0.64	0.00	2.56	5.24	6.19	6.88	7.73	10.42	11.50	12.06	13.00
KUOTA E TERRENIT	80.70	80.64	80.50	80.47	80.48	80.49	80.49	80.56	80.59	80.47	80.14	79.10	79.91	80.23	80.85

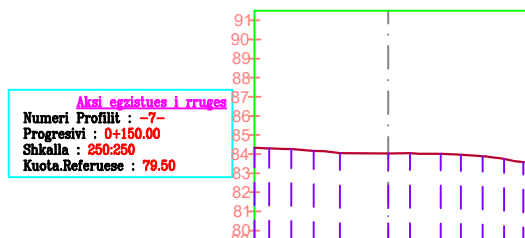

DIST.PROGRES.TERENIT	-5.06	-3.91	-3.33	-2.54	0.00	1.14	2.75	3.54	4.61	5.12
KUOTA E TERRENIT	84.28	84.17	84.15	84.04	84.03	84.05	84.01	83.99	83.91	83.88

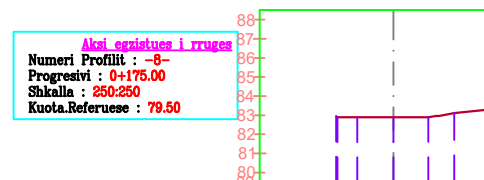

DIST.PROGRES.TERENIT	-3.00	-2.88	-1.88	0.00	1.82	2.39	3.18	4.90
KUOTA E TERRENIT	82.94	82.89	82.89	82.90	82.96	83.11	83.30	

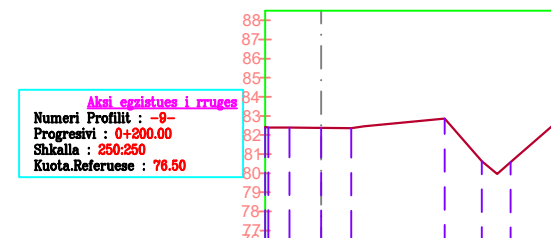

DIST.PROGRES.TERENIT	-1.06	0.00	1.58	2.26	6.46	8.41	9.20	9.91	12.59
KUOTA E TERRENIT	82.39	82.37	82.85	82.47	82.85	80.62	79.96	80.59	82.90

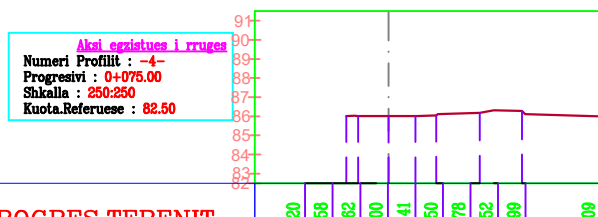

DIST.PROGRES.TERENIT	-2.20	-1.58	-0.62	0.00	1.41	2.50	4.78	5.52	6.99	11.09
KUOTA E TERRENIT	86.01	86.01	86.01	86.01	86.01	86.05	86.31	86.28	86.99	

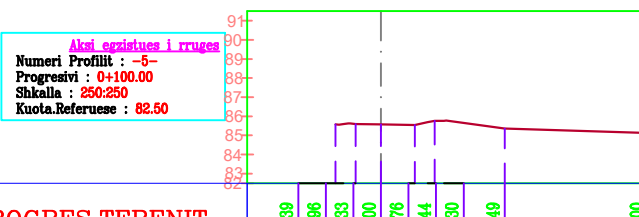

DIST.PROGRES.TERENIT	-2.39	-1.96	-1.33	0.00	1.76	2.44	3.30	6.49	14.00
KUOTA E TERRENIT	85.58	85.59	85.60	85.57	85.54	85.70	85.76	85.36	85.13

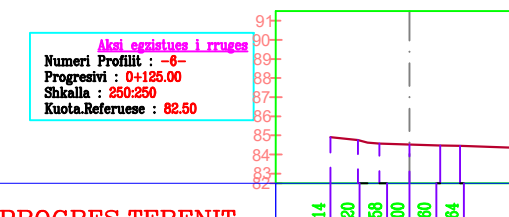

DIST.PROGRES.TERENIT	-4.14	-2.20	-1.58	0.00	1.60	2.64	6.89	11.20	13.36	14.77	16.28	19.04
KUOTA E TERRENIT	84.01	84.63	84.56	84.52	84.48	84.46	84.31	84.34	84.59	84.46	84.26	84.16

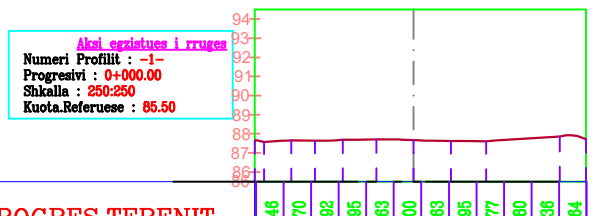

DIST.PROGRES.TERENIT	-4.46	-3.70	-2.92	-1.95	-0.63	0.00	0.83	1.95	2.77	3.80	4.36	7.64
KUOTA E TERRENIT	87.04	87.69	87.69	87.70	87.69	87.66	87.63	87.62	87.62	87.60	87.66	87.86

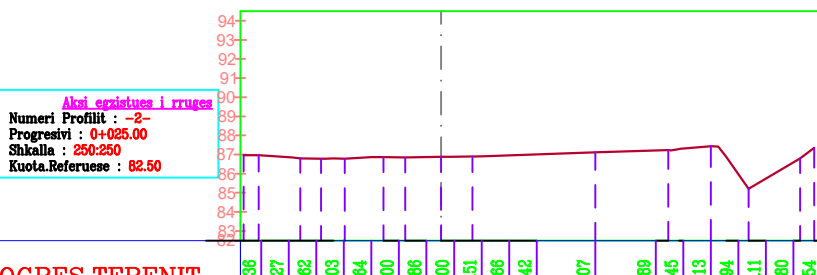

DIST.PROGRES.TERENIT	-7.36	-6.27	-5.62	-5.03	-3.64	-3.00	-1.86	0.00	0.51	1.66	2.42	8.07	11.89	12.45	14.13	14.94	16.11	18.80	19.54
KUOTA E TERRENIT	86.81	86.78	86.80	86.79	86.86	86.87	86.85	86.88	86.88	86.89	86.91	87.12	87.23	87.28	87.43	86.89	85.21	86.79	87.35

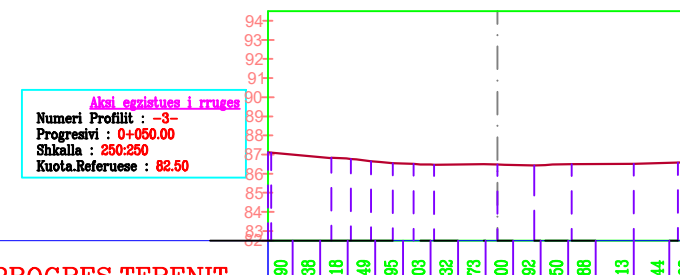

DIST.PROGRES.TERENIT	-7.90	-7.39	-6.18	-5.49	-4.95	-4.03	-3.32	-0.73	0.00	1.92	2.50	3.88	7.13	9.44	9.98
KUOTA E TERRENIT	86.79	86.75	86.61	86.55	86.53	86.48	86.47	86.49	86.47	86.43	86.44	86.50	86.51	86.58	86.60

Rilevimi Topografik (Profilet terthore) Pk.13-Pk.23



REPUBLIKA E SHQIPERISE
BASHKIA PATOS
DREJTORIA E PLANIFIKIMIT URBAN,
PROJEKTEVE, SHERBIMEVE DHE
EMERGJENCAVE CIVILE

EMERTIMI I PROJEKTIT:

**RIKONSTRUKSION I
RRUGES "LAGJJA E RE"
TEK PERROI CAM**

EMERTIMI I FLETES:

Rilevimi Topografik
PROFILET TERTHORE
Pk.13-PK.23

GRUPI I PROJEKTIMIT:

Ing. Top Marsilda Kamberaj
Ing.
Ark.
Ing elek.

DREJTORIA E PLANIFIKIMIT
URBAN, PROJEKTEVE,
SHERBIMEVE DHE
EMERGJENCAVE CIVILE

Ing. Boreta Murati

SHKALLA

Fleta: NR 15

1:

KORRIK 2023

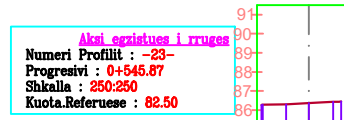
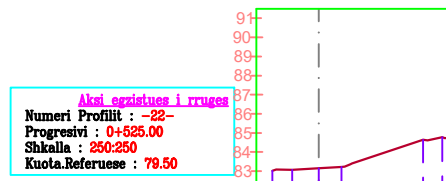

DIST.PROGRES.TERENIT	-2.42	-2.21	-1.39	0.00	1.19	1.75	5.47	6.47
KUOTA E TERRENIT	83.01	83.08	83.07	83.15	83.21	83.41	84.63	84.78

DIST.PROGRES.TERENIT	-1.19	0.00	0.61
KUOTA E TERRENIT	86.30	86.37	86.40

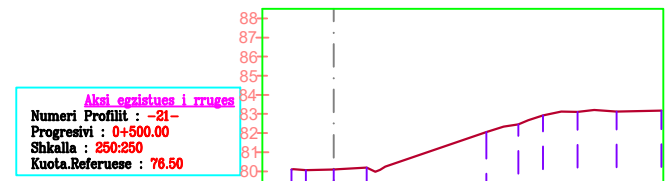
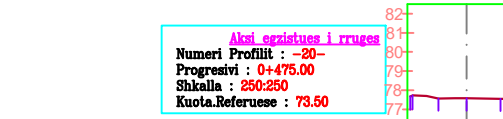
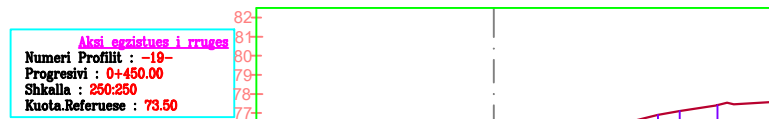

DIST.PROGRES.TERENIT	-10.41	-9.69	-7.56	-6.20	-5.50	-4.84	-3.43	-0.59	0.00	1.83	6.02	6.60	9.74	11.71	12.22	14.82
KUOTA E TERRENIT	76.91	76.94	76.94	76.98	76.00	76.00	76.05	76.09	76.10	76.14	76.27	76.90	77.11	77.42	77.54	77.60

DIST.PROGRES.TERENIT	-1.47	-0.62	0.00	1.78
KUOTA E TERRENIT	77.57	77.58	77.57	77.55

DIST.PROGRES.TERENIT	-1.46	0.00	1.72	2.42	7.98	8.88	9.65	10.17	10.95	11.90	12.75	13.63	14.81	17.15
KUOTA E TERRENIT	80.06	80.10	80.19	80.07	82.05	82.33	82.46	82.67	82.92	83.12	83.11	83.20	83.12	83.17

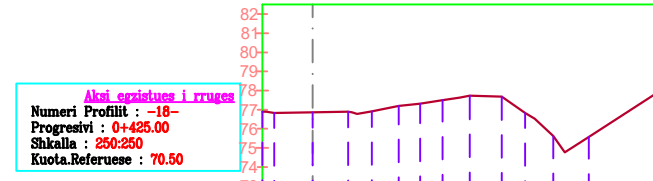
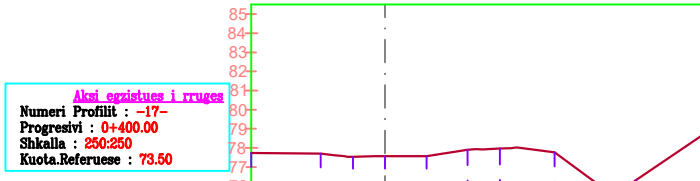
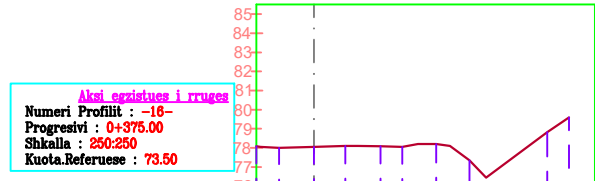

DIST.PROGRES.TERENIT	-2.79	-1.82	0.00	1.65	2.30	3.48	4.62	5.44	6.40	7.12	8.14	9.01	12.21	13.35
KUOTA E TERRENIT	78.05	78.01	78.05	78.10	78.10	78.08	78.05	78.19	78.20	78.10	77.95	78.44	78.82	79.59

DIST.PROGRES.TERENIT	-7.00	-3.37	-2.68	-1.68	-0.56	0.00	2.17	4.31	5.10	6.01	6.63	8.87	11.61	13.12	17.01
KUOTA E TERRENIT	77.73	77.68	77.61	77.54	77.56	77.56	77.56	77.90	77.91	77.97	77.99	77.77	76.76	76.31	76.94

DIST.PROGRES.TERENIT	-2.94	-2.61	0.00	1.85	3.10	4.50	5.63	6.79	7.70	8.23	9.90	11.12	11.62	12.59	13.19	14.46
KUOTA E TERRENIT	76.90	76.89	76.88	76.86	76.89	77.19	77.31	77.49	77.63	77.72	77.67	76.82	76.53	75.63	74.77	75.58

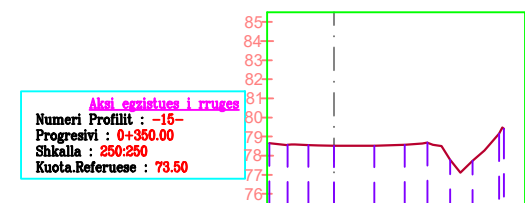
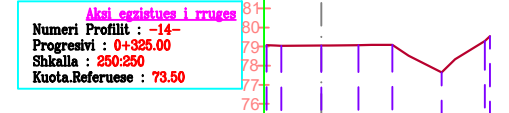
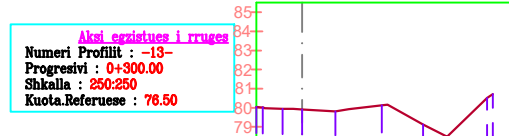

DIST.PROGRES.TERENIT	-1.03	0.00	1.74	2.45	4.18	6.33	7.58	9.68	9.99
KUOTA E TERRENIT	79.94	79.91	79.80	79.83	80.12	79.12	78.49	80.51	80.72

DIST.PROGRES.TERENIT	-2.09	0.00	1.95	2.63	3.72	4.57	6.29	7.00	8.55	8.82
KUOTA E TERRENIT	79.05	79.07	79.09	79.09	79.09	78.51	77.64	78.33	79.30	79.54

DIST.PROGRES.TERENIT	-1.34	-0.82	0.00	2.12	3.70	4.63	5.17	6.09	6.61	7.28
KUOTA E TERRENIT	78.56	78.53	78.52	78.57	78.63	78.67	77.78	77.11	77.74	

Rilevimi Topografik BAZAMENTI GJEODEZIK

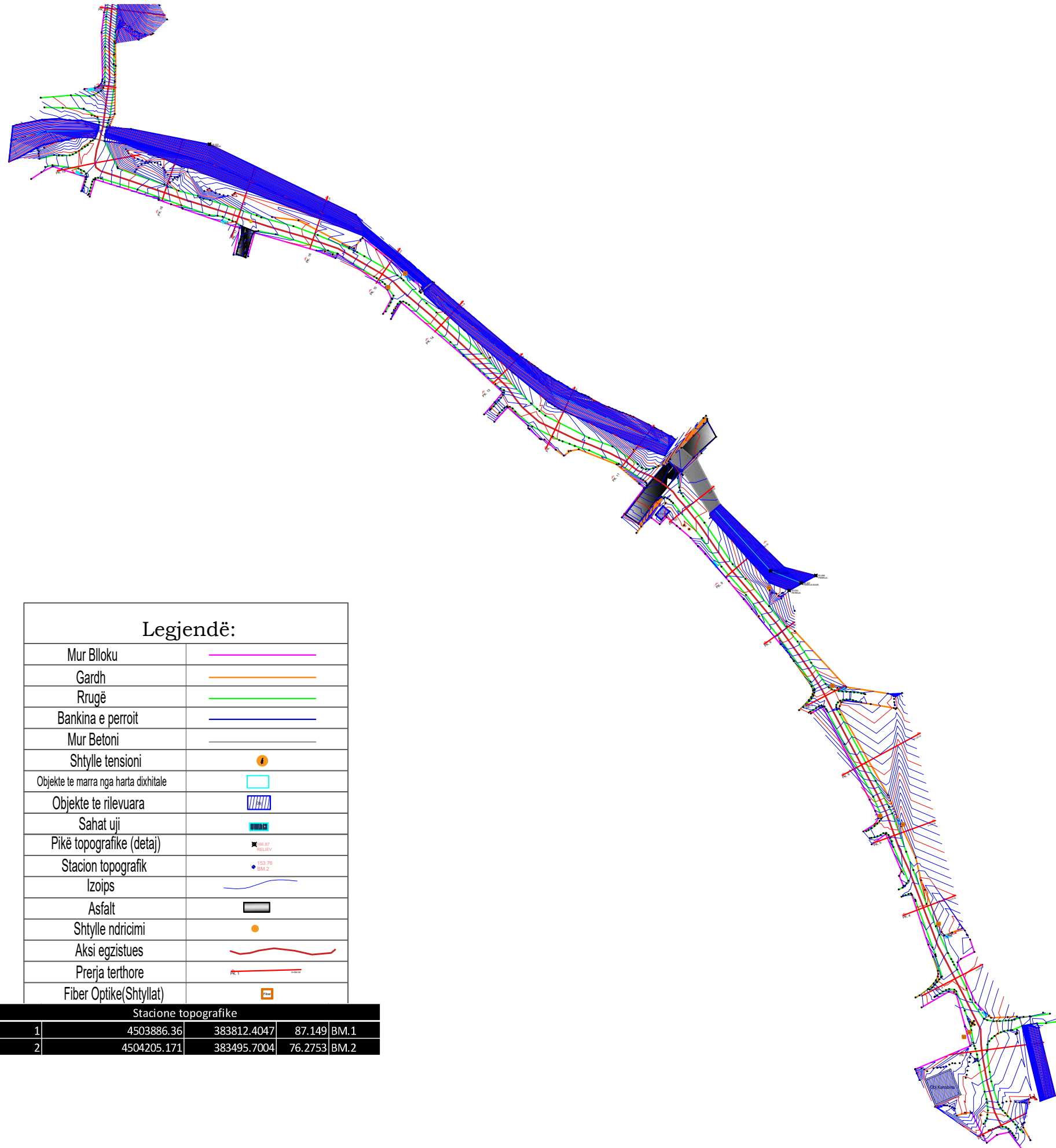

Legjendë:

Mur Blloku	
Gardh	
Rrugë	
Bankina e perroit	
Mur Betoni	
Shtylle tensioni	
Objekte te marra nga harta dixhitale	
Objekte te rilevuara	
Sahat uji	
Pikë topografike (detaj)	
Stacion topografik	
Izoips	
Asfalt	
Shtylle ndricimi	
Aksi egzistues	
Prerja terthore	
Fiber Optike(Shtyllat)	

Stacione topografike			
1	4503886.36	383812.4047	87.149 BM.1
2	4504205.171	383495.7004	76.2753 BM.2



REPUBLIKA E SHQIPERISE
BASHKIA PATOS
DREJTORIA E PLANIFIKIMIT URBAN,
PROJEKTEVE, SHERBIMEVE DHE
EMERGJENCAVE CIVILE

EMERTIMI I PROJEKTIT:

**RIKONSTRUKSION I
RRUGES "LAGJJA E RE"
TEK PERROI CAM**

EMERTIMI I FLETES:

Rilevimi Topografik
BAZAMENTI GJEODEZIK

Stacione topografike			
1	4503886.36	383812.4047	87.149 BM.1
2	4504205.171	383495.7004	76.2753 BM.2

GRUPI I PROJEKTIMIT:

Ing. Top **Marsilda Kamberaj**

Ing.

Ark.

Ing elek.

DREJTORIA E PLANIFIKIMIT
URBAN, PROJEKTEVE,
SHERBIMEVE DHE
EMERGJENCAVE CIVILE

Ing. Boreta Murati

SHKALLA

1:

Fleta: NR 16

KORRIK 2023



REPUBLIKA E SHQIPERISE
BASHKIA PATOS
DREJTORIA E PANIFIKIMIT URBAN, PROJEKTEVE, SHERBIMEVE DHE EMERGJENCAVE
CIVILE

OBJEKTI: RIKONSTRUKSION I RRUGES "LAGJJA E RE" TE PERROI ÇAM

PLANI I PRISHJEVE

Nr. i fleteve: 12 (dymbëdhjetë) flete

Grupi i Projektimit: **Ing. Top. Marsilda Kamberaj**
Ing. Silvana Mici
Ark. Arlind Rusto

Drejtore :

Ing. Boreta MURATI

MIRATOHET
KRYETAR
FATION DURO

Korrik 2023



REPUBLIKA E SHQIPERISE
BASHKIA PATOS
DREJTORIA E PLANIFIKIMIT URBAN,
PROJEKTEVE, SHERBIMEVE DHE
EMERGJENCAVE CIVILE

EMERTIMI I PROJEKTIT:

**RIKONSTRUKSION I
RRUGES "LAGJJA E RE"
TEK PERROI CAM**

EMERTIMI I FLETES:

PLANI I PRISHJEVE

GRUPI I PROJEKTIMIT:

ING. SILVANA MICI
ING.
ARK.
ING EL.

DREJTORIA E PLANIFIKIMIT
URBAN, PROJEKTEVE,
SHERBIMEVE DHE
EMERGJENCAVE CIVILE

ING. BORETA MURATI



SHKALLA

1:200

Fleta: NR 1

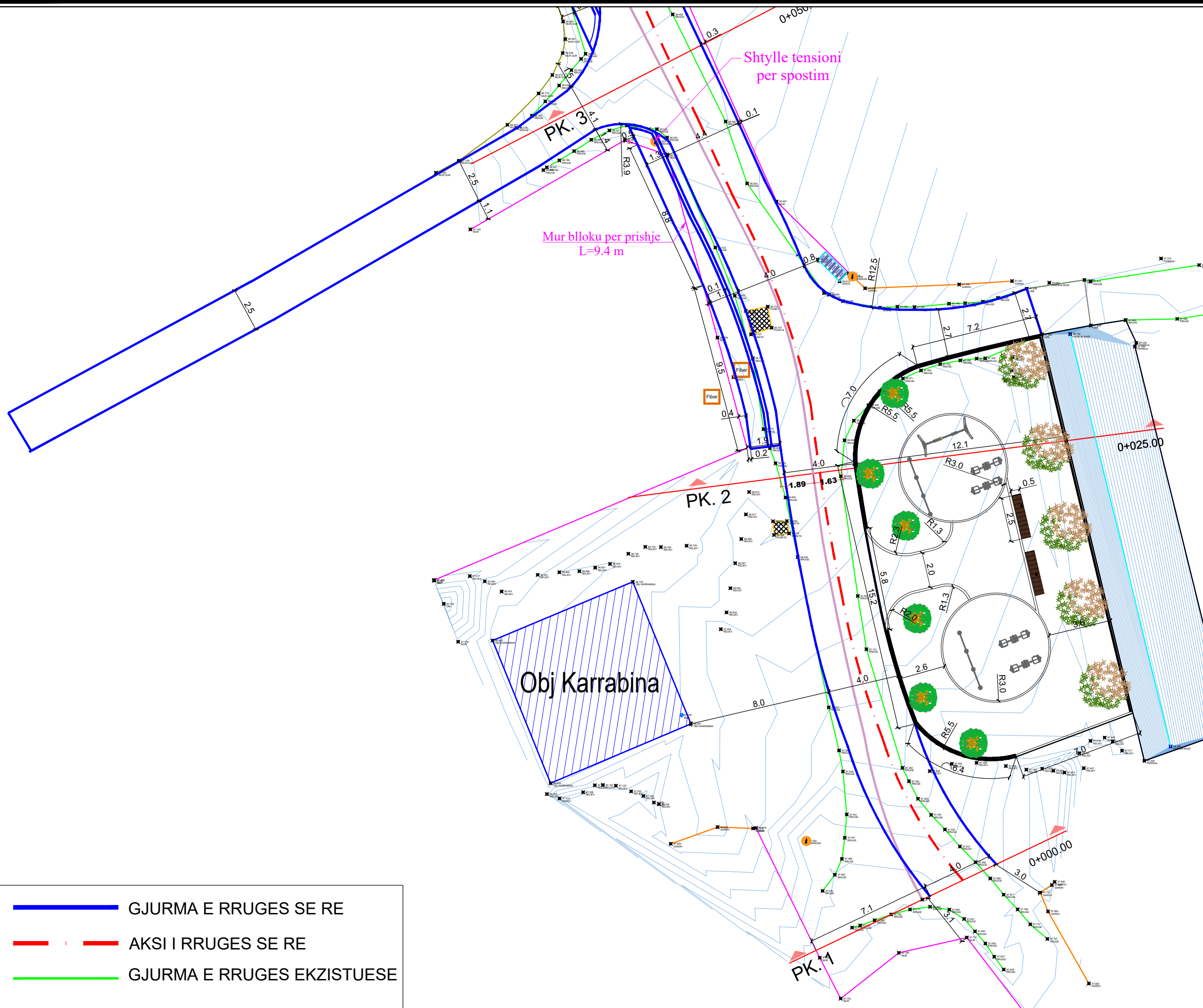
KORRIK 2023



-  GJURMA E RRUGES SE RE
-  AKSI I RRUGES SE RE
-  GJURMA E RRUGES EKZISTUESE



REPUBLIKA E SHQIPERISE
BASHKIA PATOS
DREJTORIA E PLANIFIKIMIT URBAN,
PROJEKTEVE, SHERBIMEVE DHE
EMERGJENCAVE CIVILE

EMERTIMI I PROJEKTIT:

**RIKONSTRUKSION I
RRUGES "LAGJJA E RE"
TEK PERROI CAM**

EMERTIMI I FLETES:

PLANI I PRISHJEVE

GRUPI I PROJEKTIMIT:

ING. SILVANA MICI
ING.
ARK.
ING EL.

DREJTORIA E PLANIFIKIMIT
URBAN, PROJEKTEVE,
SHERBIMEVE DHE
EMERGJENCAVE CIVILE

ING. BORETA MURATI



SHKALLA

1:200

Fleta: NR 2

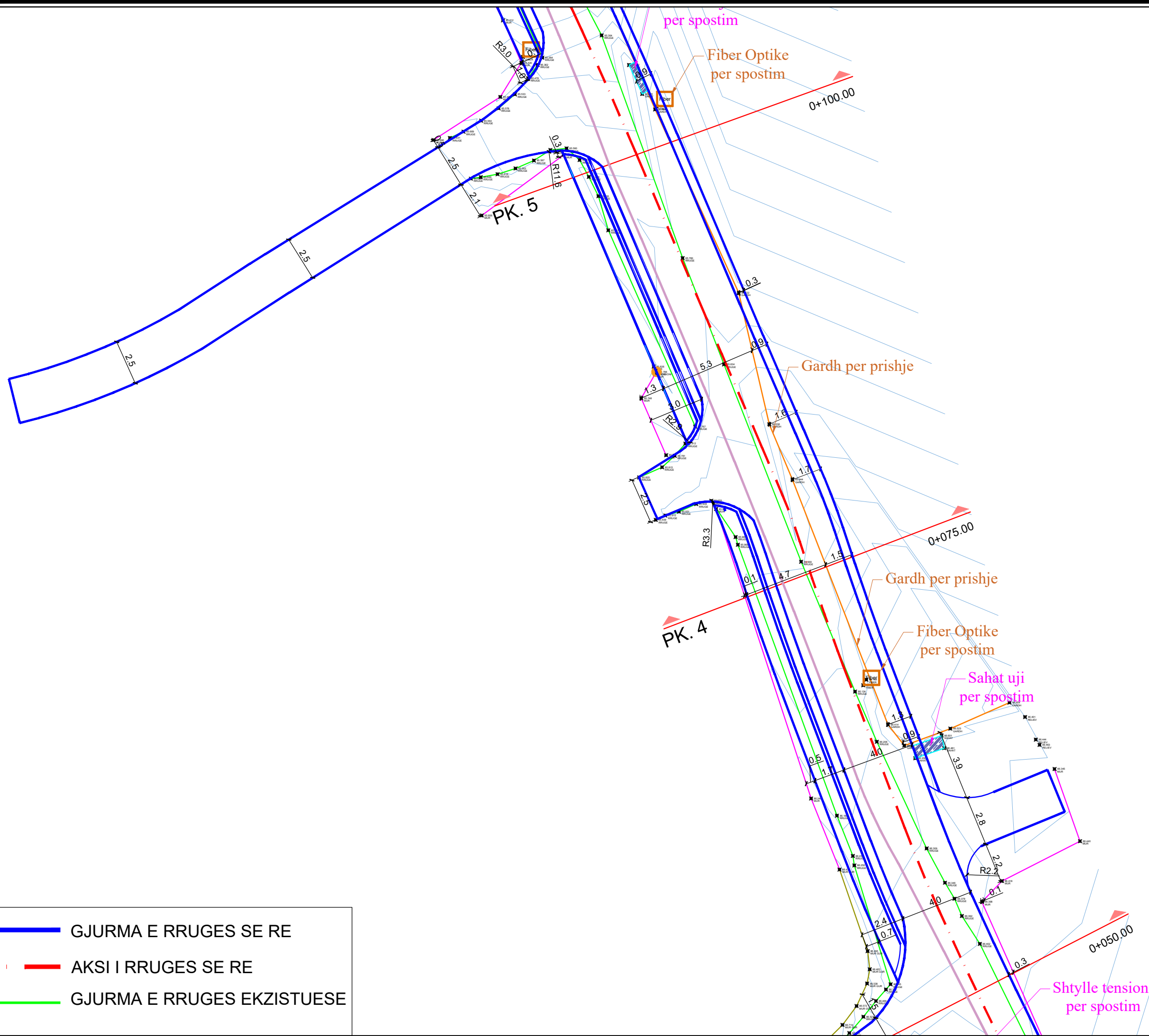
KORRIK 2023



-  GJURMA E RRUGES SE RE
-  AKSI I RRUGES SE RE
-  GJURMA E RRUGES EKZISTUESE



REPUBLIKA E SHQIPERISE
BASHKIA PATOS
DREJTORIA E PLANIFIKIMIT URBAN,
PROJEKTEVE, SHERBIMEVE DHE
EMERGJENCAVE CIVILE

EMERTIMI I PROJEKTIT:

**RIKONSTRUKSION I
RRUGES "LAGJJA E RE"
TEK PERROI CAM**

EMERTIMI I FLETES:

PLANI I PRISHJEVE

GRUPI I PROJEKTIMIT:

ING. SILVANA MICI
ING.
ARK.
ING EL.

DREJTORIA E PLANIFIKIMIT
URBAN, PROJEKTEVE,
SHERBIMEVE DHE
EMERGJENCAVE CIVILE

ING. BORETA MURATI



SHKALLA

1:200

Fleta: NR 3

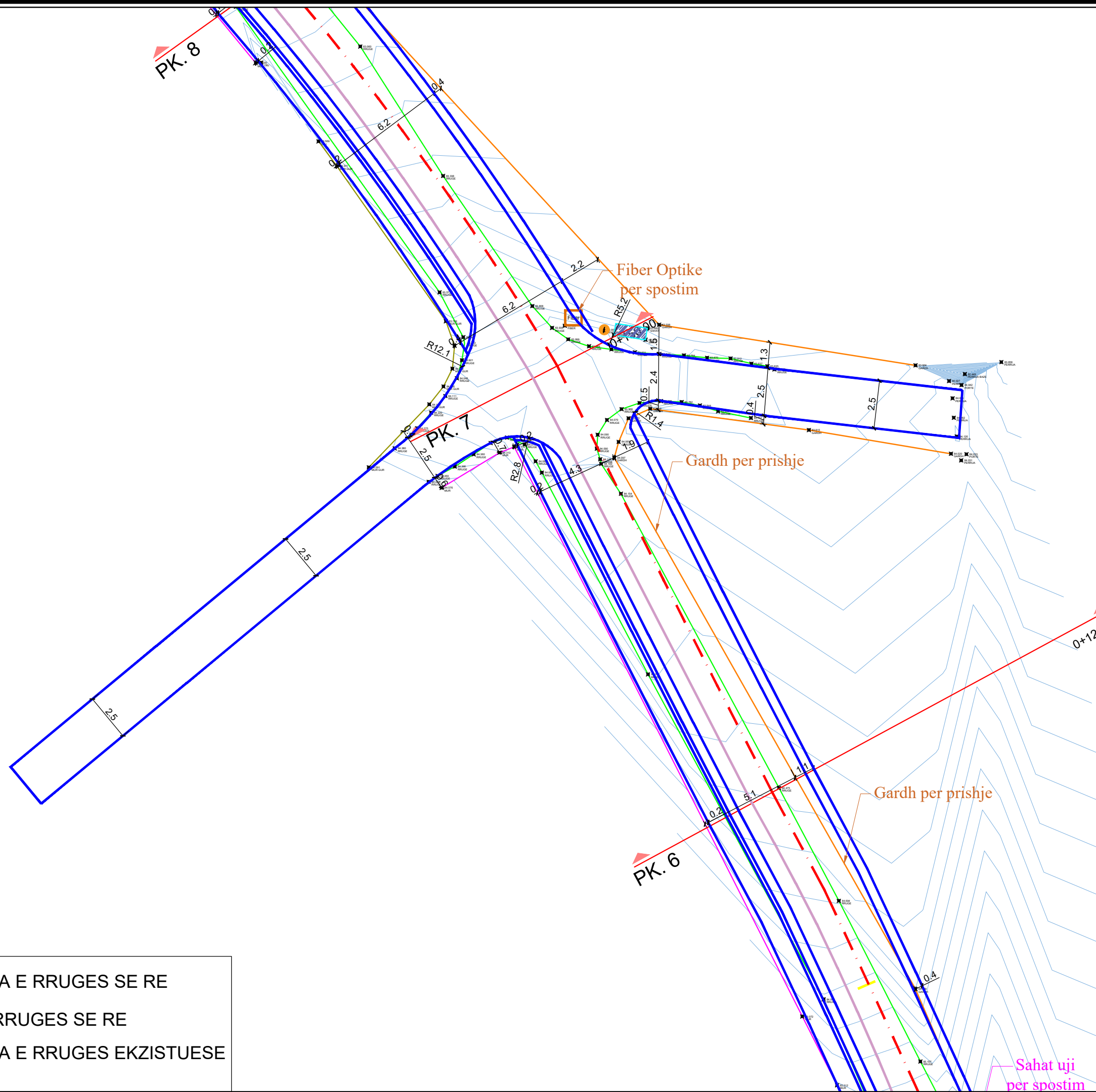
KORRIK 2023



-  GJURMA E RRUGES SE RE
-  AKSI I RRUGES SE RE
-  GJURMA E RRUGES EKZISTUESE



REPUBLIKA E SHQIPERISE
BASHKIA PATOS
DREJTORIA E PLANIFIKIMIT URBAN,
PROJEKTEVE, SHERBIMEVE DHE
EMERGJENCAVE CIVILE

EMERTIMI I PROJEKTIT:

**RIKONSTRUKSION I
RRUGES "LAGJJA E RE"
TEK PERROI CAM**

EMERTIMI I FLETES:

PLANI I PRISHJEVE

GRUPI I PROJEKTIMIT:

ING. SILVANA MICI
ING.
ARK.
ING EL.

DREJTORIA E PLANIFIKIMIT
URBAN, PROJEKTEVE,
SHERBIMEVE DHE
EMERGJENCAVE CIVILE

ING. BORETA MURATI

SHKALLA

1:200

Fleta: NR 4

KORRIK 2023

PK. 17

R3.8

R8.6

0+225.00

PK. 10

Kabina elektrike

PK. 9

0+200.00

79.956
PERRUA BAZE

80.421
PERRUA

83.663
PERRUA



Fiber

6.2

Gardh per

0+175.00

PK. 8

-  GJURMA E RRUGES SE RE
-  AKSI I RRUGES SE RE
-  GJURMA E RRUGES EKZISTUESE



REPUBLIKA E SHQIPERISE
BASHKIA PATOS
DREJTORIA E PLANIFIKIMIT URBAN,
PROJEKTEVE, SHERBIMEVE DHE
EMERGJENCAVE CIVILE

EMERTIMI I PROJEKTIT:

**RIKONSTRUKSION I
RRUGES "LAGJJA E RE"
TEK PERROI CAM**

EMERTIMI I FLETES:

PLANI I PRISHJEVE

GRUPI I PROJEKTIMIT:

ING. SILVANA MICI
ING.
ARK.
ING EL.

DREJTORIA E PLANIFIKIMIT
URBAN, PROJEKTEVE,
SHERBIMEVE DHE
EMERGJENCAVE CIVILE

ING. BORETA MURATI



SHKALLA

1:200

Fleta: NR 6

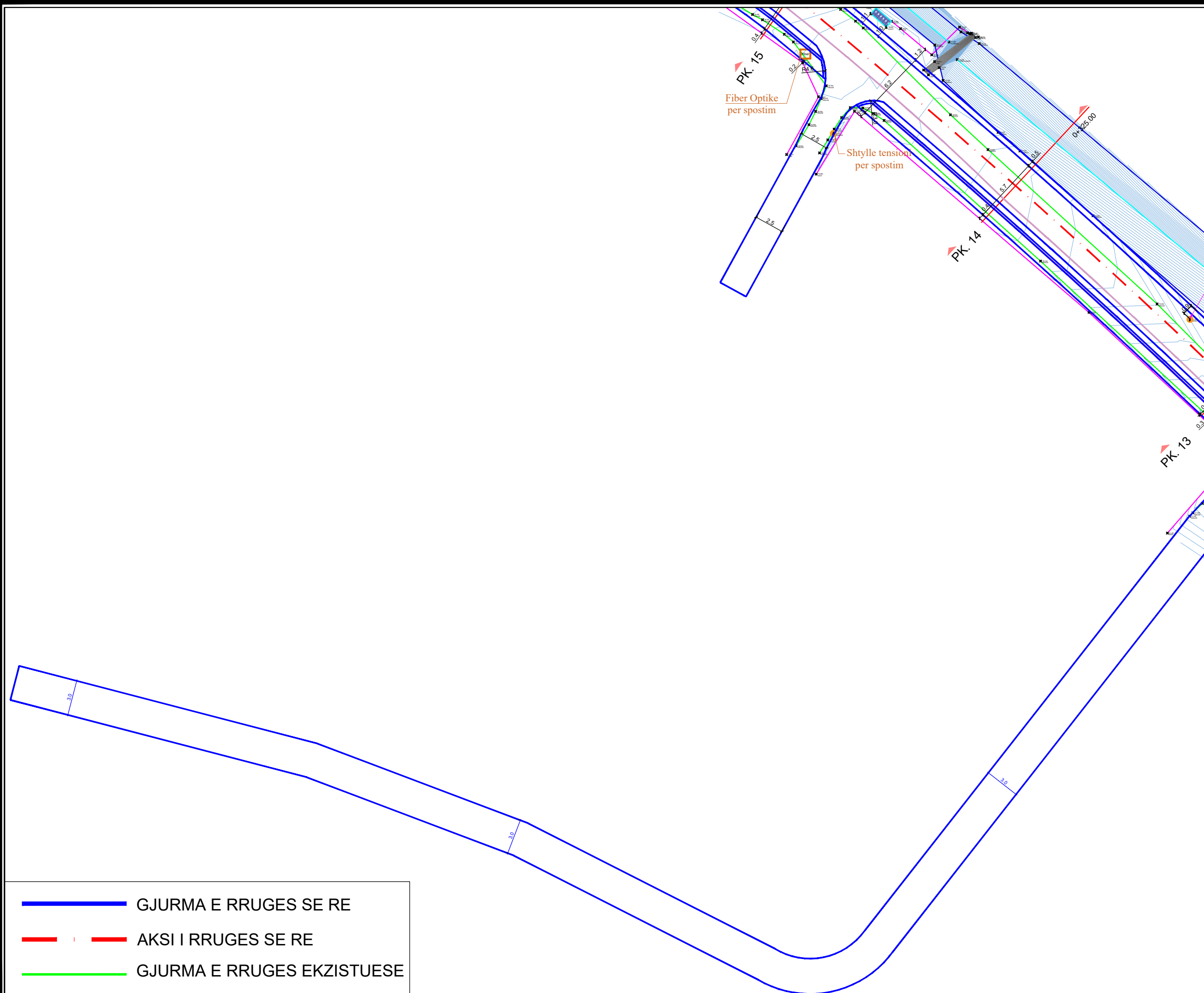
KORRIK 2023



-  GJURMA E RRUGES SE RE
-  AKSI I RRUGES SE RE
-  GJURMA E RRUGES EKZISTUESE



REPUBLIKA E SHQIPERISE
BASHKIA PATOS
DREJTORIA E PLANIFIKIMIT URBAN,
PROJEKTEVE, SHERBIMEVE DHE
EMERGJENCAVE CIVILE

EMERTIMI I PROJEKTIT:

**RIKONSTRUKSION I
RRUGES "LAGJJA E RE"
TEK PERROI CAM**

EMERTIMI I FLETES:

PLANI I PRISHJEVE

GRUPI I PROJEKTIMIT:

ING. SILVANA MICI
ING.
ARK.
ING EL.

DREJTORIA E PLANIFIKIMIT
URBAN, PROJEKTEVE,
SHERBIMEVE DHE
EMERGJENCAVE CIVILE

ING. BORETA MURATI



SHKALLA

1:200

Fleta: NR 7

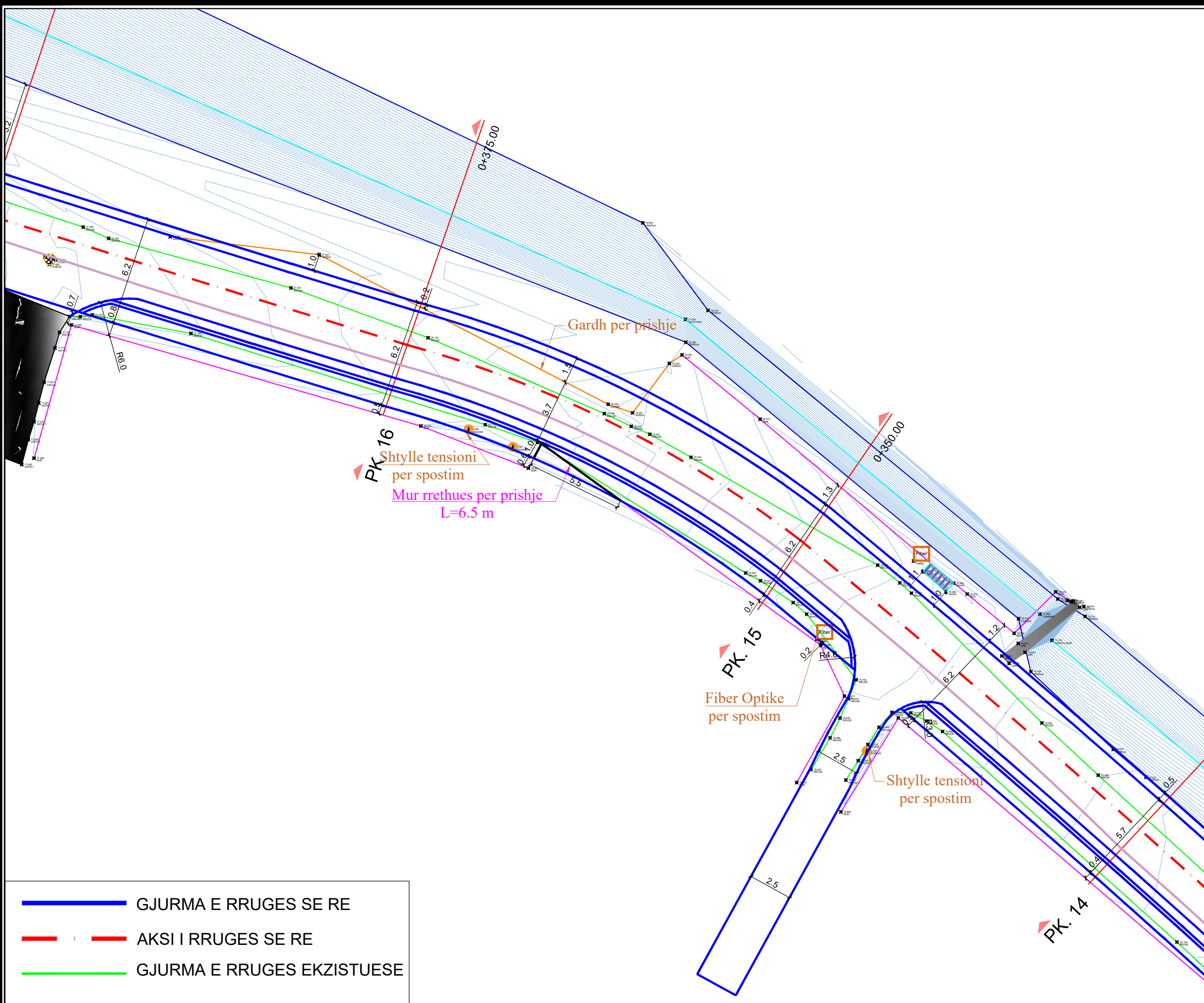
KORRIK 2023



-  GJURMA E RRUGES SE RE
-  AKSI I RRUGES SE RE
-  GJURMA E RRUGES EKZISTUESE



REPUBLIKA E SHQIPERISE
BASHKIA PATOS
DREJTORIA E PLANIFIKIMIT URBAN,
PROJEKTEVE, SHERBIMEVE DHE
EMERGJENCAVE CIVILE

EMERTIMI I PROJEKTIT:

**RIKONSTRUKSION I
RRUGES "LAGJJA E RE"
TEK PERROI CAM**

EMERTIMI I FLETES:

PLANI I PRISHJEVE

GRUPI I PROJEKTIMIT:

ING. SILVANA MICI
ING.
ARK.
ING EL.

DREJTORIA E PLANIFIKIMIT
URBAN, PROJEKTEVE,
SHERBIMEVE DHE
EMERGJENCAVE CIVILE

ING. BORETA MURATI

SHKALLA

1:200

Fleta: NR 8

KORRIK 2023

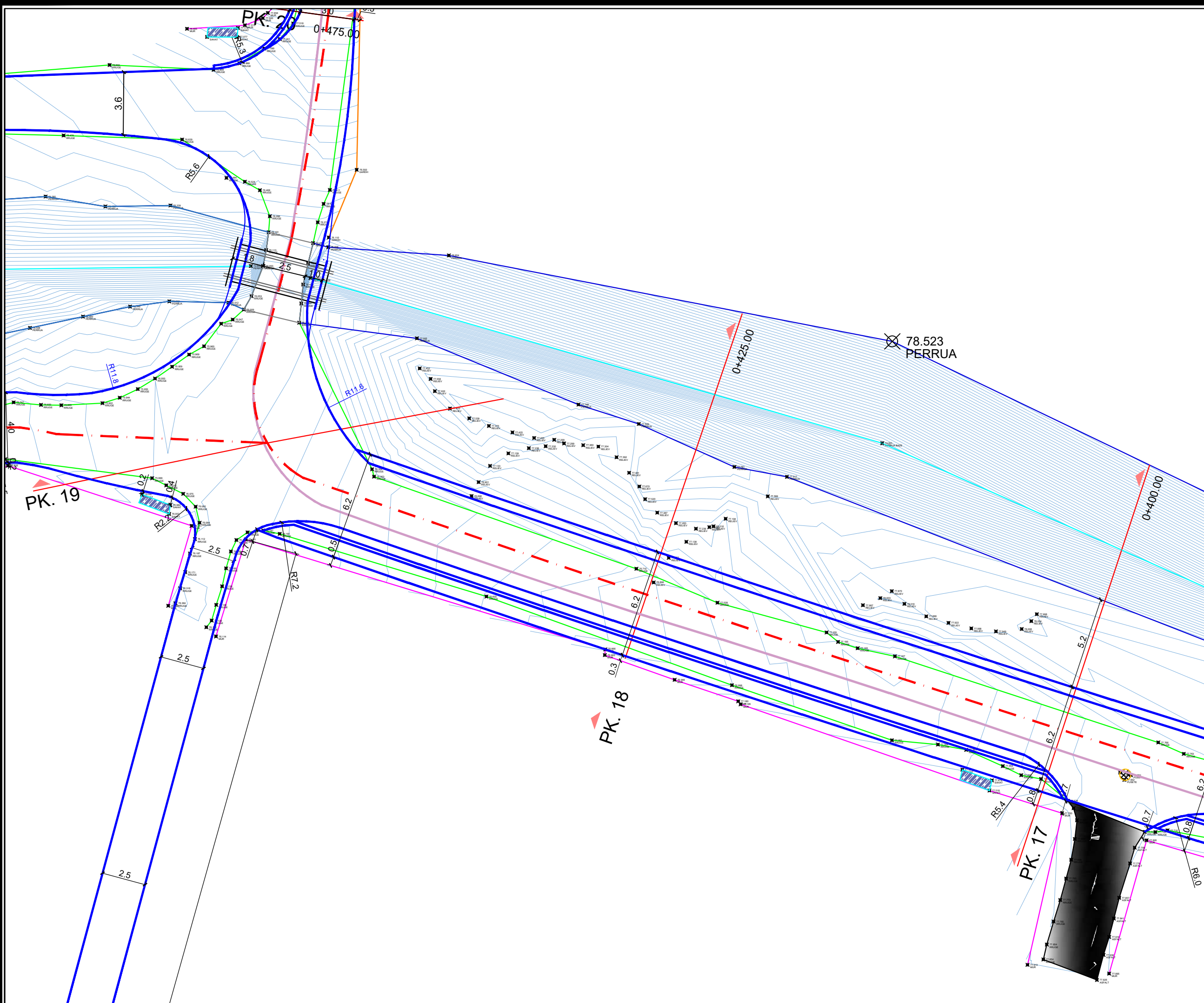



REPUBLIKA E SHQIPERISE
BASHKIA PATOS
DREJTORIA E PLANIFIKIMIT URBAN,
PROJEKTEVE, SHERBIMEVE DHE
EMERGJENCAVE CIVILE

EMERTIMI I PROJEKTIT:

**RIKONSTRUKSION I
RRUGES "LAGJJA E RE"
TEK PERROI CAM**

EMERTIMI I FLETES:

PLANI I PRISHJEVE

GRUPI I PROJEKTIMIT:

ING. SILVANA MICI
ING.
ARK.
ING EL.

DREJTORIA E PLANIFIKIMIT
URBAN, PROJEKTEVE,
SHERBIMEVE DHE
EMERGJENCAVE CIVILE

ING. BORETA MURATI

SHKALLA

1:200

Fleta: NR 9

KORRIK 2023

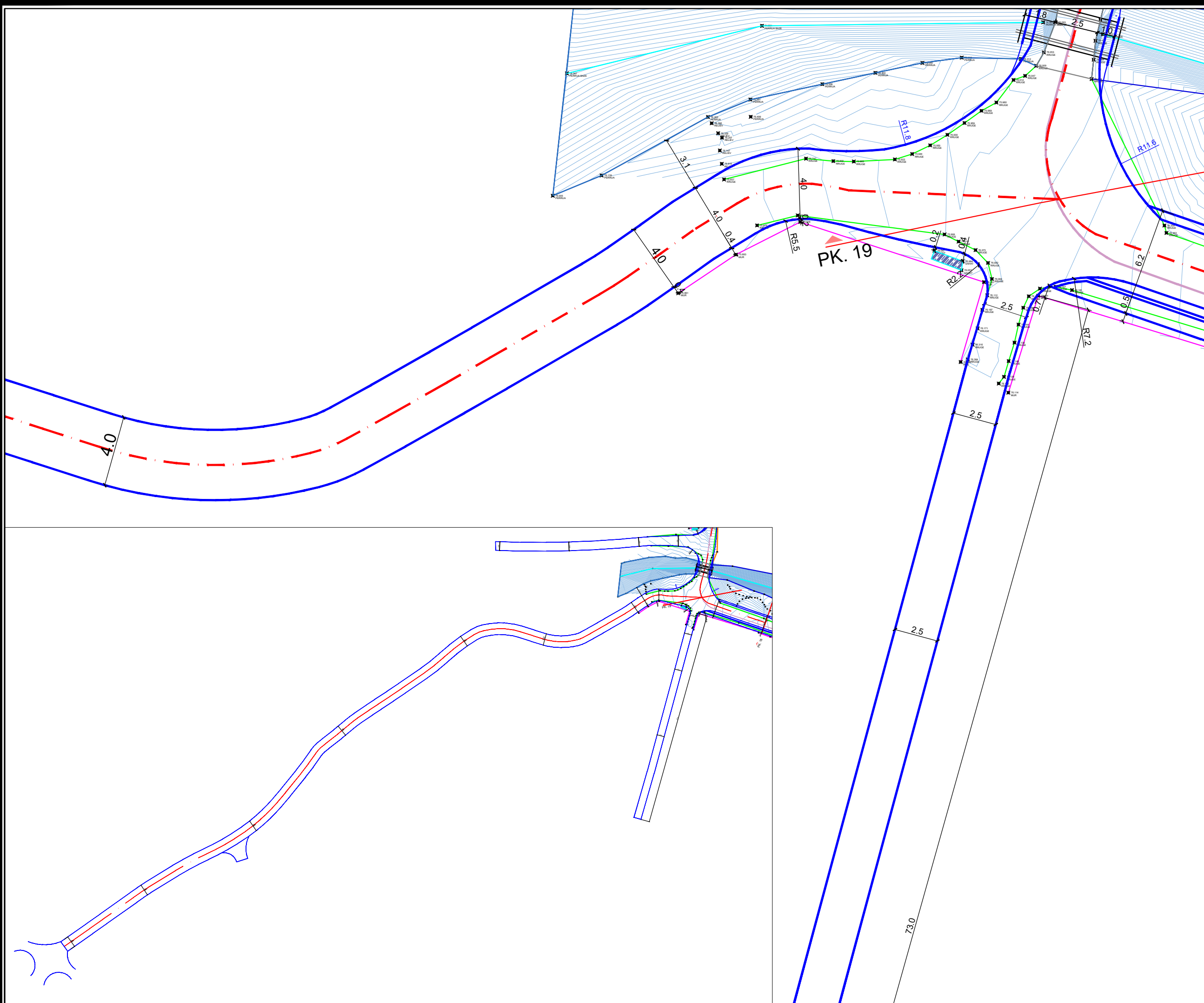



REPUBLIKA E SHQIPERISE
BASHKIA PATOS
DREJTORIA E PLANIFIKIMIT URBAN,
PROJEKTEVE, SHERBIMEVE DHE
EMERGJENCAVE CIVILE

EMERTIMI I PROJEKTIT:

**RIKONSTRUKSION I
RRUGES "LAGJJA E RE"
TEK PERROI CAM**

EMERTIMI I FLETES:

PLANI I PRISHJEVE

GRUPI I PROJEKTIMIT:

ING. SILVANA MICI
ING.
ARK.
ING EL.

DREJTORIA E PLANIFIKIMIT
URBAN, PROJEKTEVE,
SHERBIMEVE DHE
EMERGJENCAVE CIVILE

ING. BORETA MURATI

SHKALLA

1:200

Fleta: NR 11

KORRIK 2023

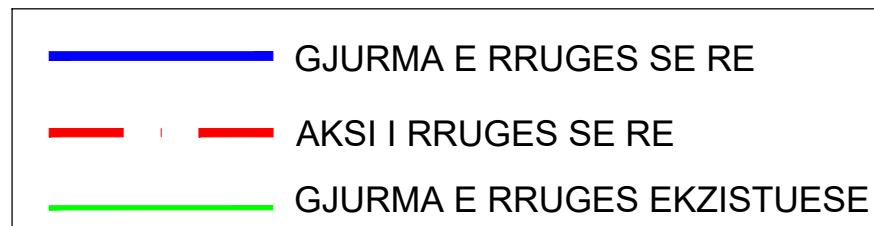
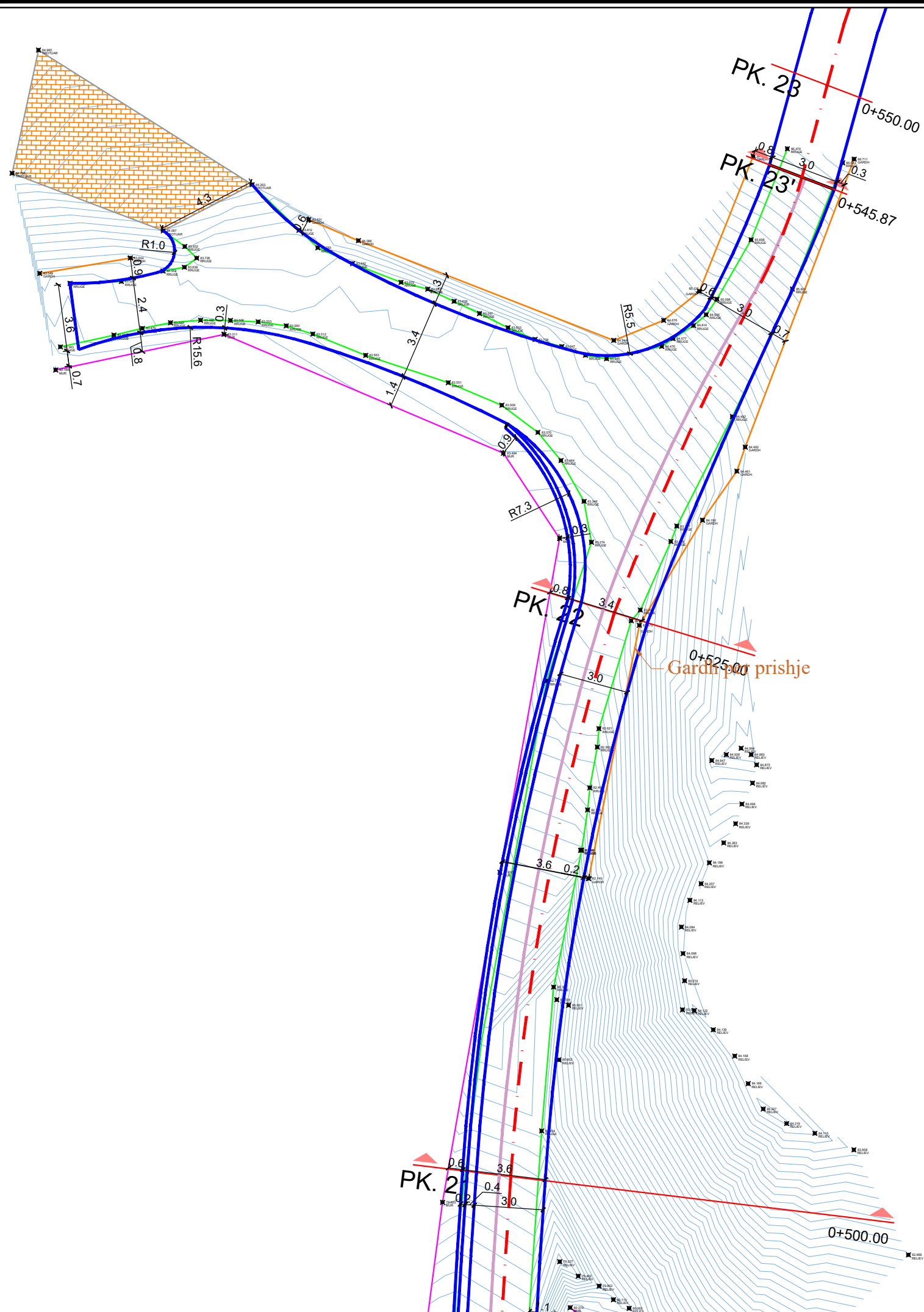



REPUBLIKA E SHQIPERISE
BASHKIA PATOS
DREJTORIA E PLANIFIKIMIT URBAN,
PROJEKTEVE, SHERBIMEVE DHE
EMERGJENCAVE CIVILE

EMERTIMI I PROJEKTIT:

**RIKONSTRUKSION I
RRUGES "LAGJJA E RE"
TEK PERROI CAM**

EMERTIMI I FLETES:

PLANI I PRISHJEVE

GRUPI I PROJEKTIMIT:

ING. SILVANA MICI
ING.
ARK.
ING EL.

DREJTORIA E PLANIFIKIMIT
URBAN, PROJEKTEVE,
SHERBIMEVE DHE
EMERGJENCAVE CIVILE

ING. BORETA MURATI

SHKALLA

1:200

Fleta: NR 12

KORRIK 2023

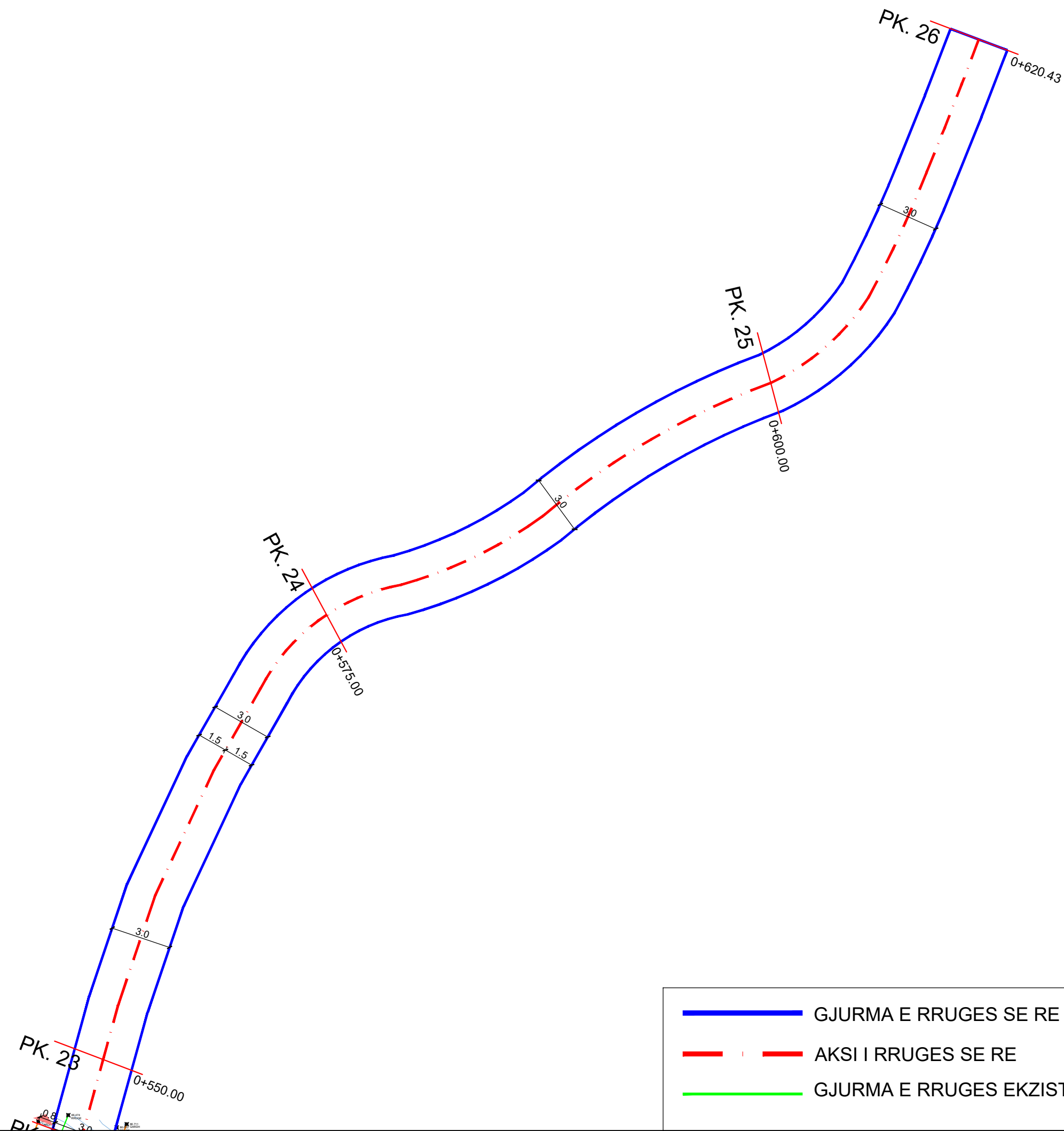



REPUBLIKA E SHQIPERISE
BASHKIA PATOS
DREJTORIA E PANIFIKIMIT URBAN, PROJEKTEVE, SHERBIMEVE DHE EMERGJENCAVE
CIVILE

OBJEKTI: RIKONSTRUKSION I RRUGES "LAGJJA E RE" TE PERROI ÇAM

PLANIMETRIA E RRUGES

Nr. i fleteve: 12 (dymbëdhjetë) flete

Grupi i Projektimit: **Ing. Silvana Mici**
Ark. Arlind Rusto

Drejtore:
Ing. Boreta MURATI

MIRATOHET
KRYETAR
FATION DURO

Korrik 2023



REPUBLIKA E SHQIPERISE
BASHKIA PATOS
DREJTORIA E PLANIFIKIMIT URBAN,
PROJEKTEVE, SHERBIMEVE DHE
EMERGJENCAVE CIVILE

EMERTIMI I PROJEKTIT:

**RIKONSTRUKSION I
RRUGES "LAGJJA E RE"
TEK PERROI CAM**

EMERTIMI I FLETES:

**PLANIMETRIA E
PERGJITHSHME E
RRUGES**

GRUPI I PROJEKTIMIT:

ING. SILVANA MICI
ARK. ARLIND RUSTO
ING EL.

DREJTORIA E PLANIFIKIMIT
URBAN, PROJEKTEVE,
SHERBIMEVE DHE
EMERGJENCAVE CIVILE

ING. BORETA MURATI

SHKALLA

1:200

Fleta: NR 1

KORRIK 2023

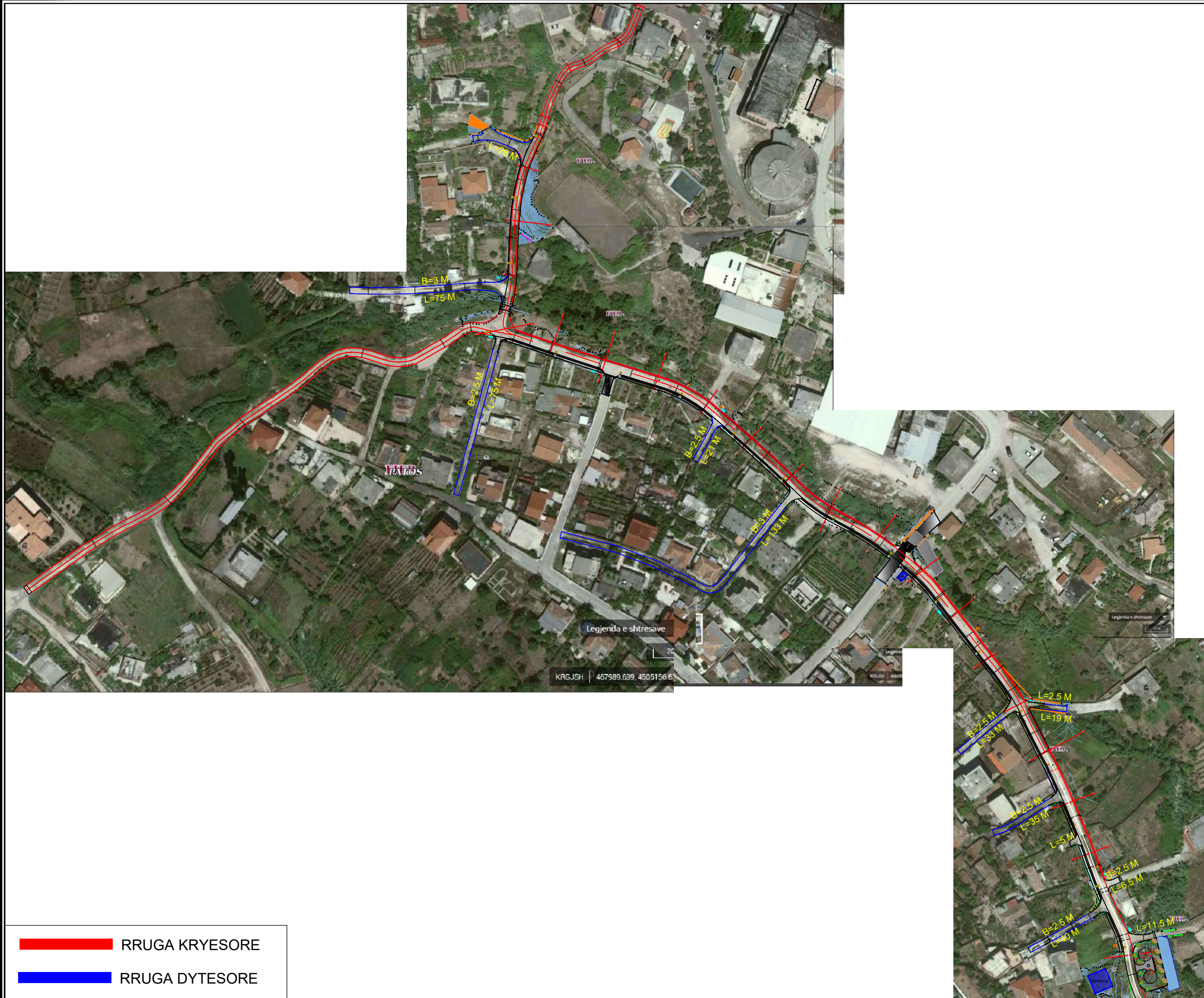

RRUGA KRYESORE
RRUGA DYTESORE



REPUBLIKA E SHQIPERISE
BASHKIA PATOS
DREJTORIA E PLANIFIKIMIT URBAN,
PROJEKTEVE, SHERBIMEVE DHE
EMERGJENCAVE CIVILE

EMERTIMI I PROJEKTIT:

**RIKONSTRUKSION I
RRUGES "LAGJJA E RE"
TEK PERROI CAM**

EMERTIMI I FLETES:

PLANIMETRIA E RRUGES

GRUPI I PROJEKTIMIT:

ING. SILVANA MICI
ARK. ARLIND RUSTO
ING EL.

DREJTORIA E PLANIFIKIMIT
URBAN, PROJEKTEVE,
SHERBIMEVE DHE
EMERGJENCAVE CIVILE

ING. BORETA MURATI

SHKALLA

1:200

Fleta: NR 3

KORRIK 2023

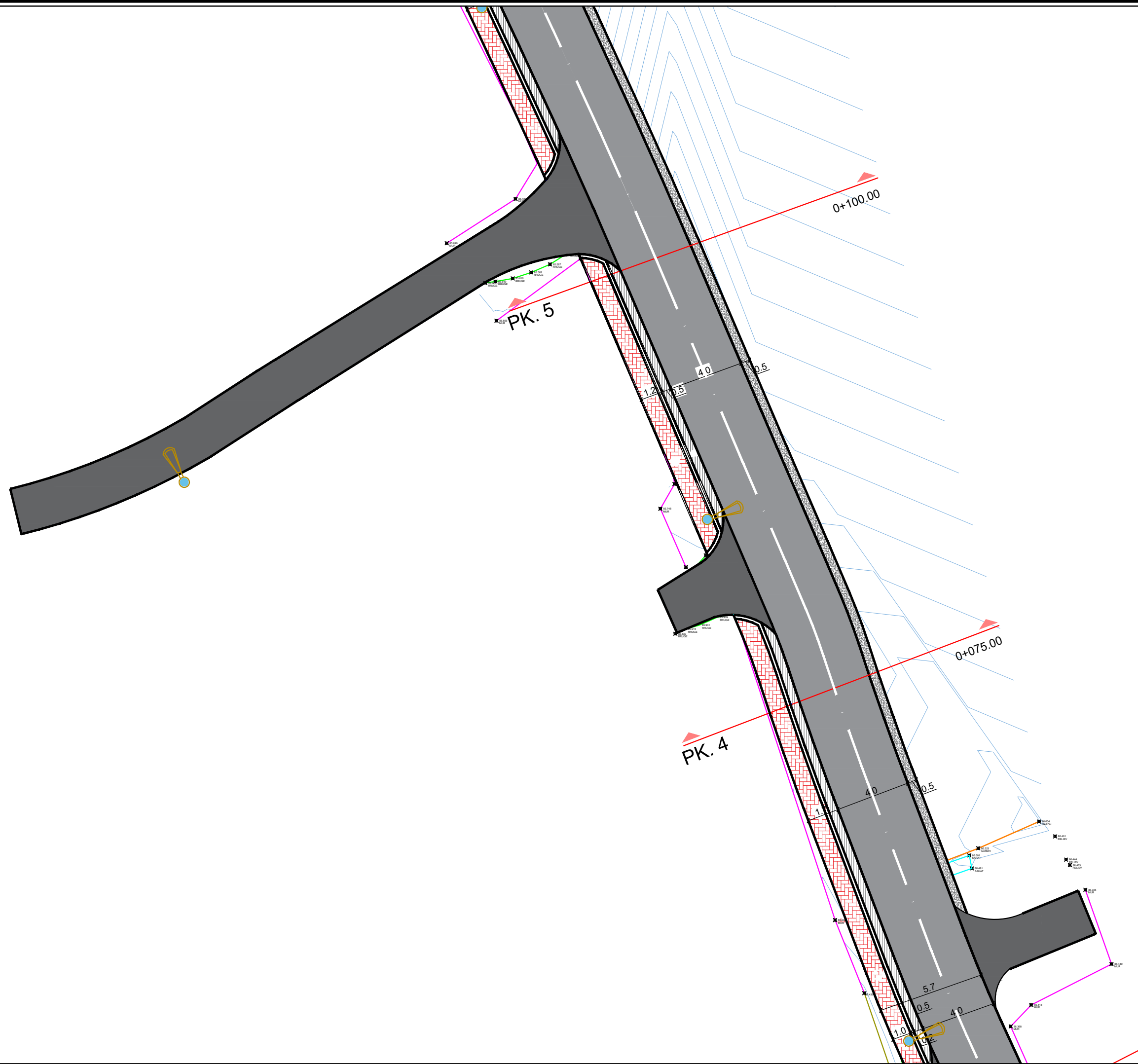



REPUBLIKA E SHQIPERISE
BASHKIA PATOS
DREJTORIA E PLANIFIKIMIT URBAN,
PROJEKTEVE, SHERBIMEVE DHE
EMERGJENCAVE CIVILE

EMERTIMI I PROJEKTIT:

**RIKONSTRUKSION I
RRUGES "LAGJJA E RE"
TEK PERROI CAM**

EMERTIMI I FLETES:

PLANIMETRIA E RRUGES

GRUPI I PROJEKTIMIT:

ING. SILVANA MICI
ARK. ARLIND RUSTO
ING EL.

DREJTORIA E PLANIFIKIMIT
URBAN, PROJEKTEVE,
SHERBIMEVE DHE
EMERGJENCAVE CIVILE

ING. BORETA MURATI

SHKALLA

1:200

Fleta: NR 4

KORRIK 2023

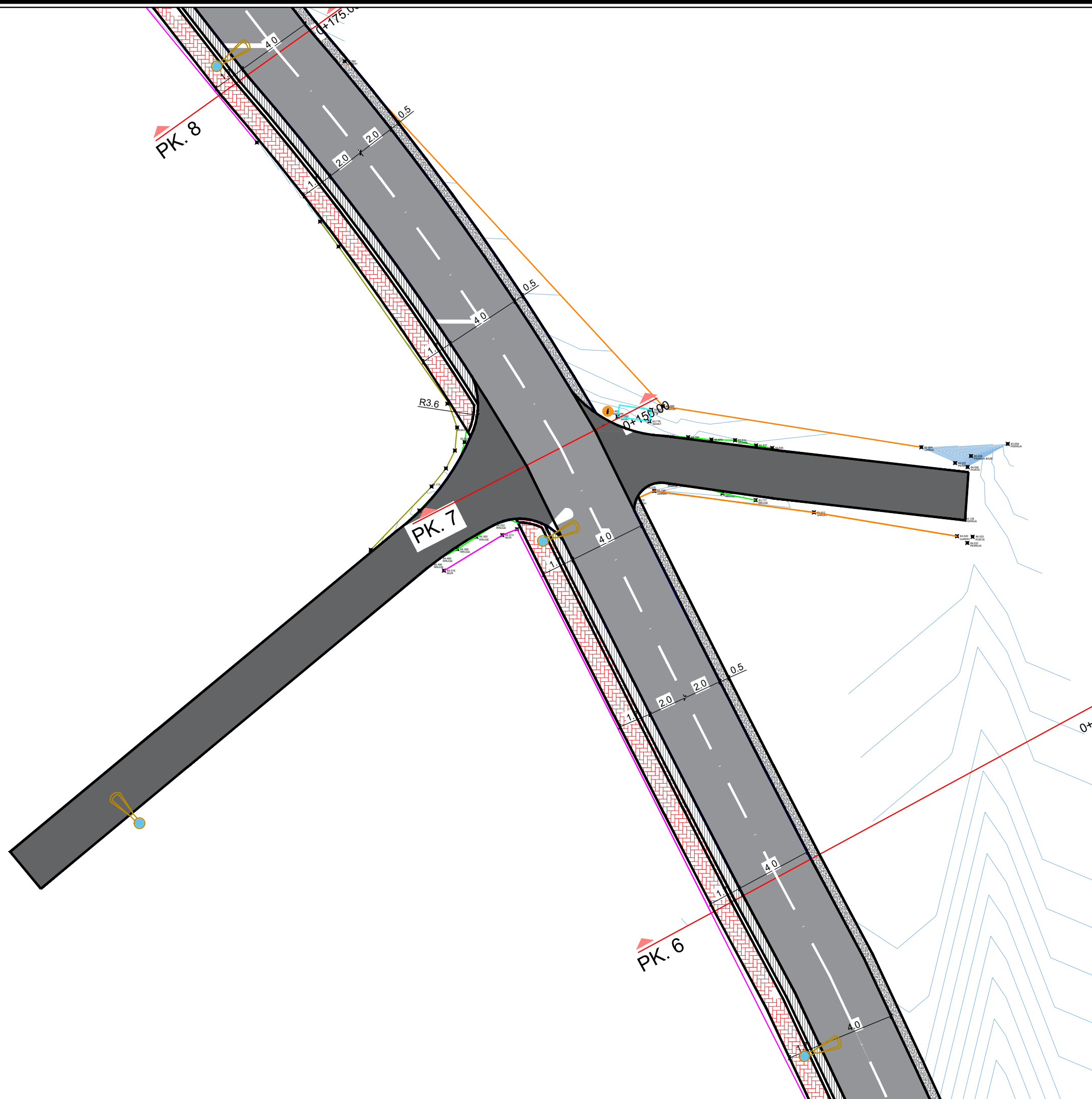



REPUBLIKA E SHQIPERISE
BASHKIA PATOS
DREJTORIA E PLANIFIKIMIT URBAN,
PROJEKTEVE, SHERBIMEVE DHE
EMERGJENCAVE CIVILE

EMERTIMI I PROJEKTIT:

**RIKONSTRUKSION I
RRUGES "LAGJJA E RE"
TEK PERROI CAM**

EMERTIMI I FLETES:

PLANIMETRIA E RRUGES

GRUPI I PROJEKTIMIT:

ING. SILVANA MICI
ARK. ARLIND RUSTO
ING EL.

DREJTORIA E PLANIFIKIMIT
URBAN, PROJEKTEVE,
SHERBIMEVE DHE
EMERGJENCAVE CIVILE

ING. BORETA MURATI

SHKALLA

1:200

Fleta: NR 5

KORRIK 2023

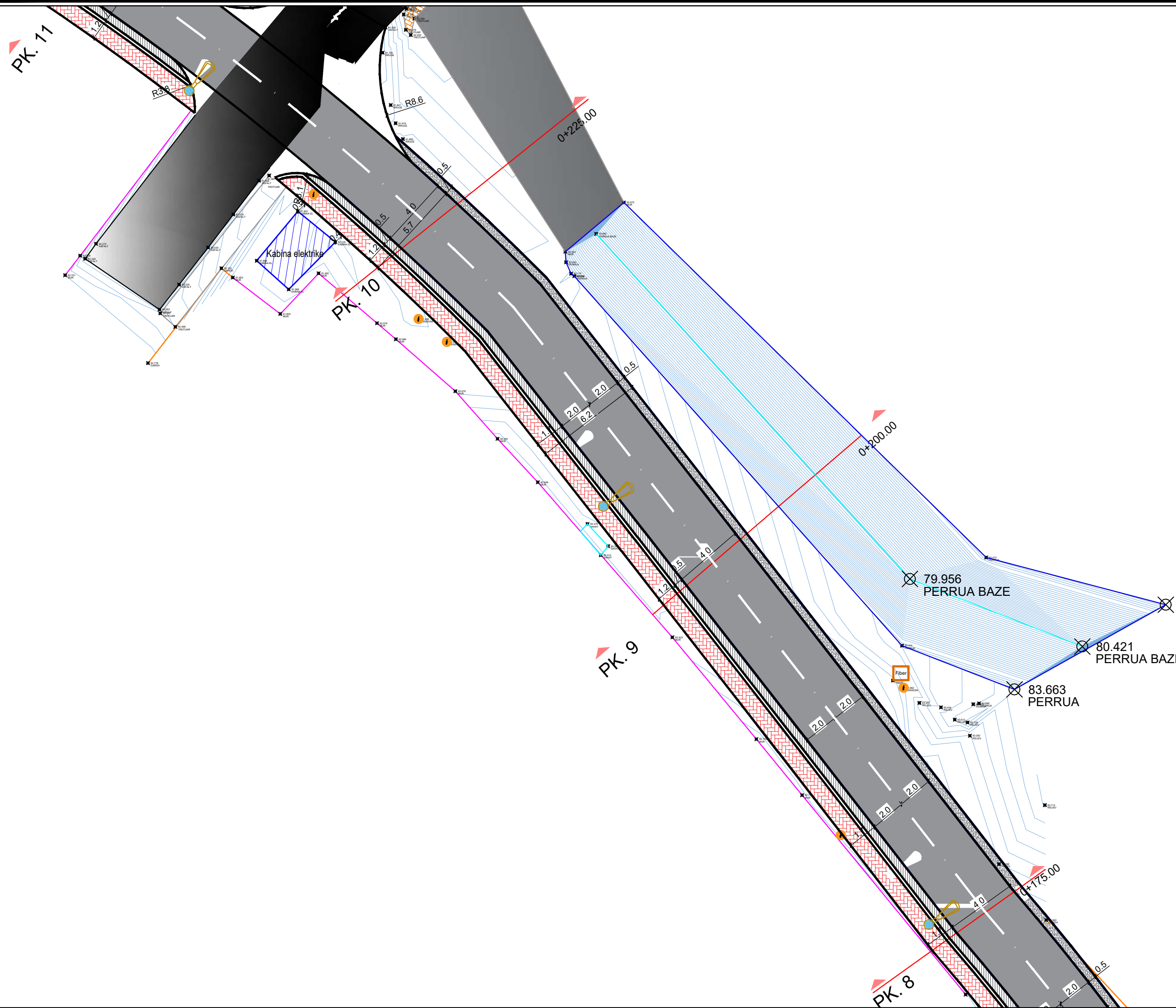



REPUBLIKA E SHQIPERISE
BASHKIA PATOS
DREJTORIA E PLANIFIKIMIT URBAN,
PROJEKTEVE, SHERBIMEVE DHE
EMERGJENCAVE CIVILE

EMERTIMI I PROJEKTIT:

**RIKONSTRUKSION I
RRUGES "LAGJJA E RE"
TEK PERROI CAM**

EMERTIMI I FLETES:

PLANIMETRIA E RRUGES

GRUPI I PROJEKTIMIT:

ING. SILVANA MICI
ARK. ARLIND RUSTO
ING EL.

DREJTORIA E PLANIFIKIMIT
URBAN, PROJEKTEVE,
SHERBIMEVE DHE
EMERGJENCAVE CIVILE

ING. BORETA MURATI

SHKALLA

1:200

Fleta: NR 6

KORRIK 2023

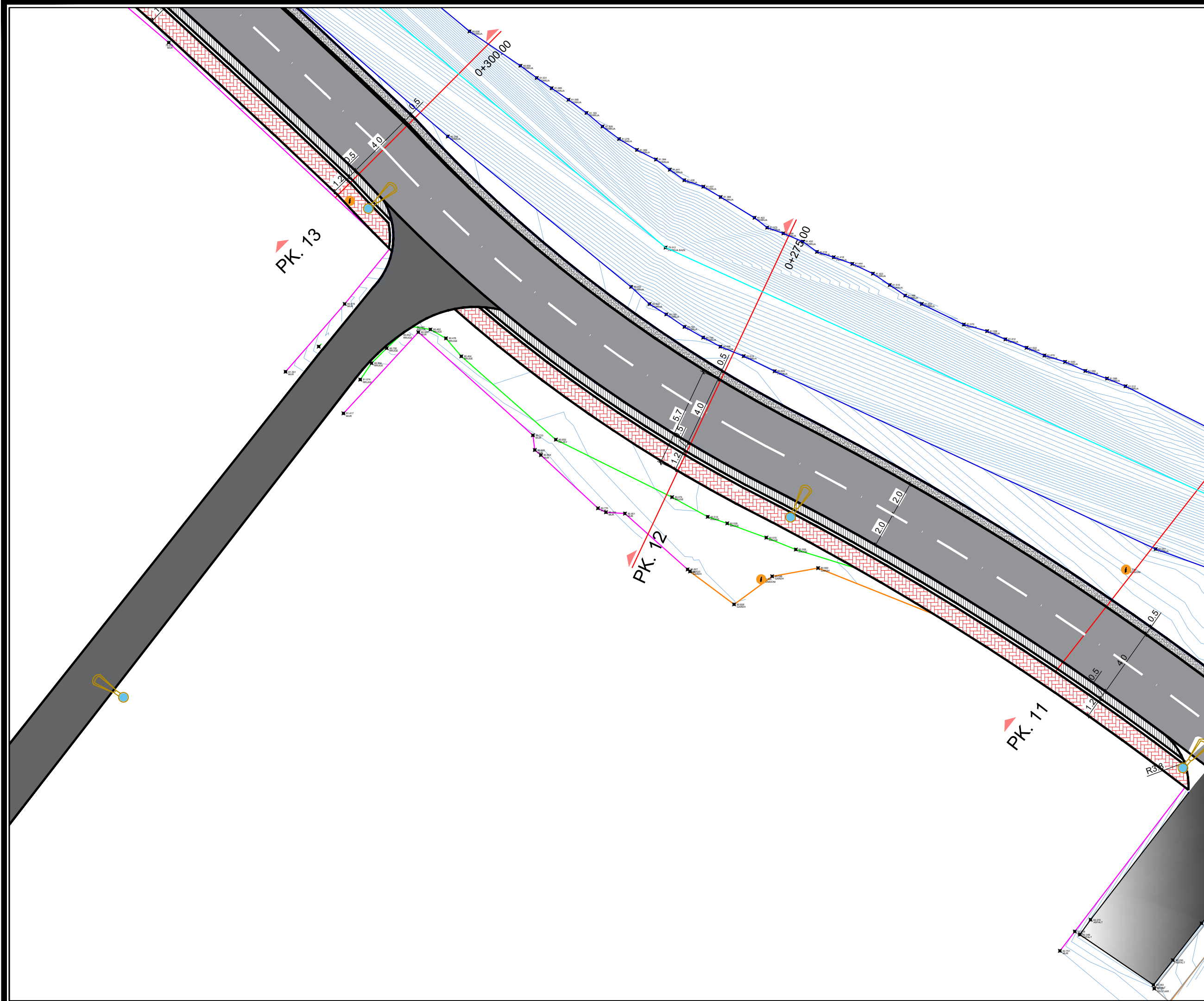



REPUBLIKA E SHQIPERISE
BASHKIA PATOS
DREJTORIA E PLANIFIKIMIT URBAN,
PROJEKTEVE, SHERBIMEVE DHE
EMERGJENCAVE CIVILE

EMERTIMI I PROJEKTIT:

**RIKONSTRUKSION I
RRUGES "LAGJJA E RE"
TEK PERROI CAM**

EMERTIMI I FLETES:

PLANIMETRIA E RRUGES

GRUPI I PROJEKTIMIT:

ING. SILVANA MICI
ARK. ARLIND RUSTO
ING EL.

DREJTORIA E PLANIFIKIMIT
URBAN, PROJEKTEVE,
SHERBIMEVE DHE
EMERGJENCAVE CIVILE

ING. BORETA MURATI

SHKALLA

1:200

Fleta: NR 7

KORRIK 2023

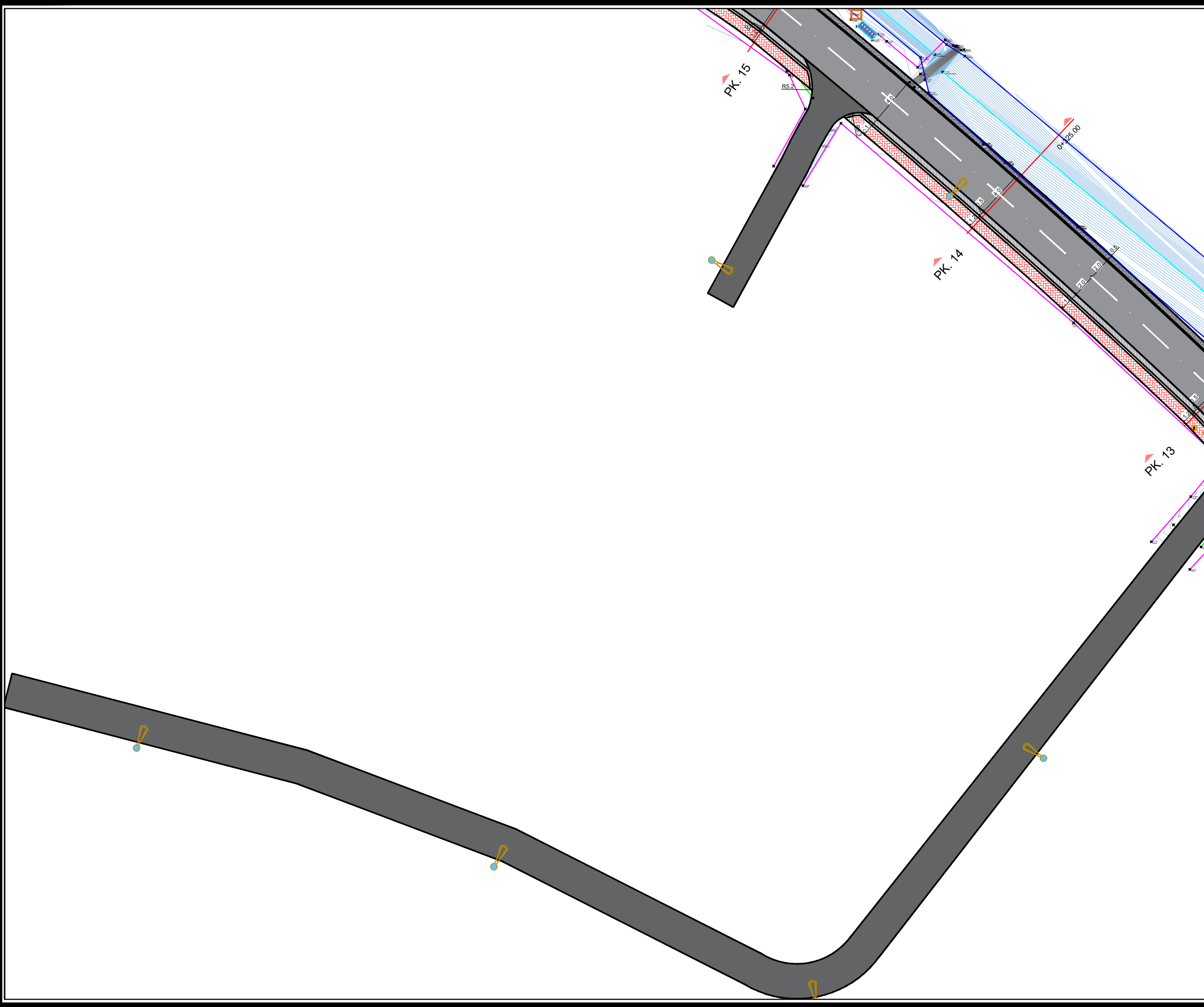



REPUBLIKA E SHQIPERISE
BASHKIA PATOS
DREJTORIA E PLANIFIKIMIT URBAN,
PROJEKTEVE, SHERBIMEVE DHE
EMERGJENCAVE CIVILE

EMERTIMI I PROJEKTIT:

**RIKONSTRUKSION I
RRUGES "LAGJJA E RE"
TEK PERROI CAM**

EMERTIMI I FLETES:

PLANIMETRIA E RRUGES

GRUPI I PROJEKTIMIT:

ING. SILVANA MICI
ARK. ARLIND RUSTO
ING EL.

DREJTORIA E PLANIFIKIMIT
URBAN, PROJEKTEVE,
SHERBIMEVE DHE
EMERGJENCAVE CIVILE

ING. BORETA MURATI

SHKALLA

1:200

Fleta: NR 9

KORRIK 2023

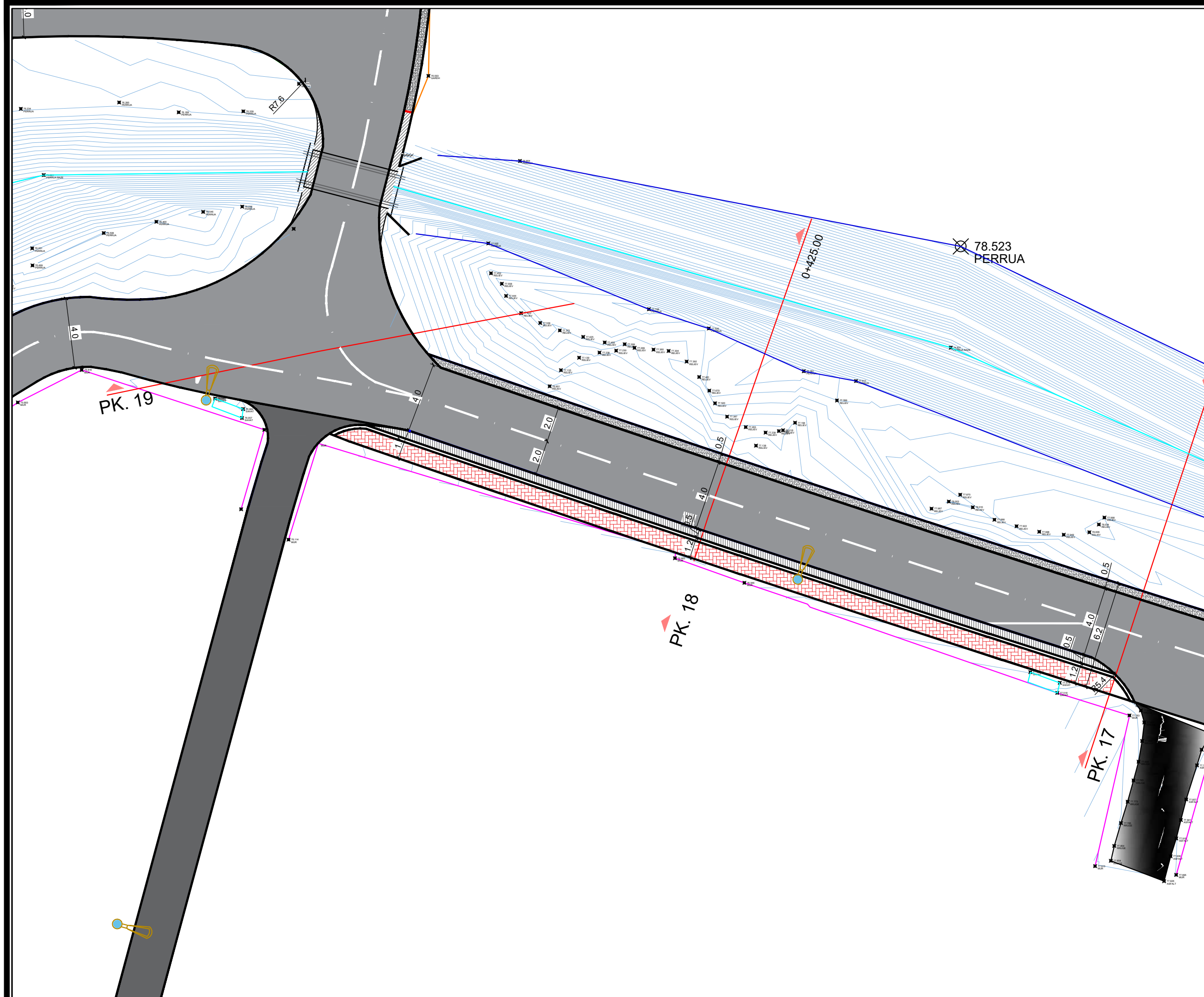



REPUBLIKA E SHQIPERISE
BASHKIA PATOS
DREJTORIA E PLANIFIKIMIT URBAN,
PROJEKTEVE, SHERBIMEVE DHE
EMERGJENCAVE CIVILE

EMERTIMI I PROJEKTIT:

**RIKONSTRUKSION I
RRUGES "LAGJJA E RE"
TEK PERROI CAM**

EMERTIMI I FLETES:

PLANIMETRIA E RRUGES

GRUPI I PROJEKTIMIT:

ING. SILVANA MICI
ARK. ARLIND RUSTO
ING EL.

DREJTORIA E PLANIFIKIMIT
URBAN, PROJEKTEVE,
SHERBIMEVE DHE
EMERGJENCAVE CIVILE

ING. BORETA MURATI

SHKALLA

1:200

Fleta: NR 10

KORRIK 2023

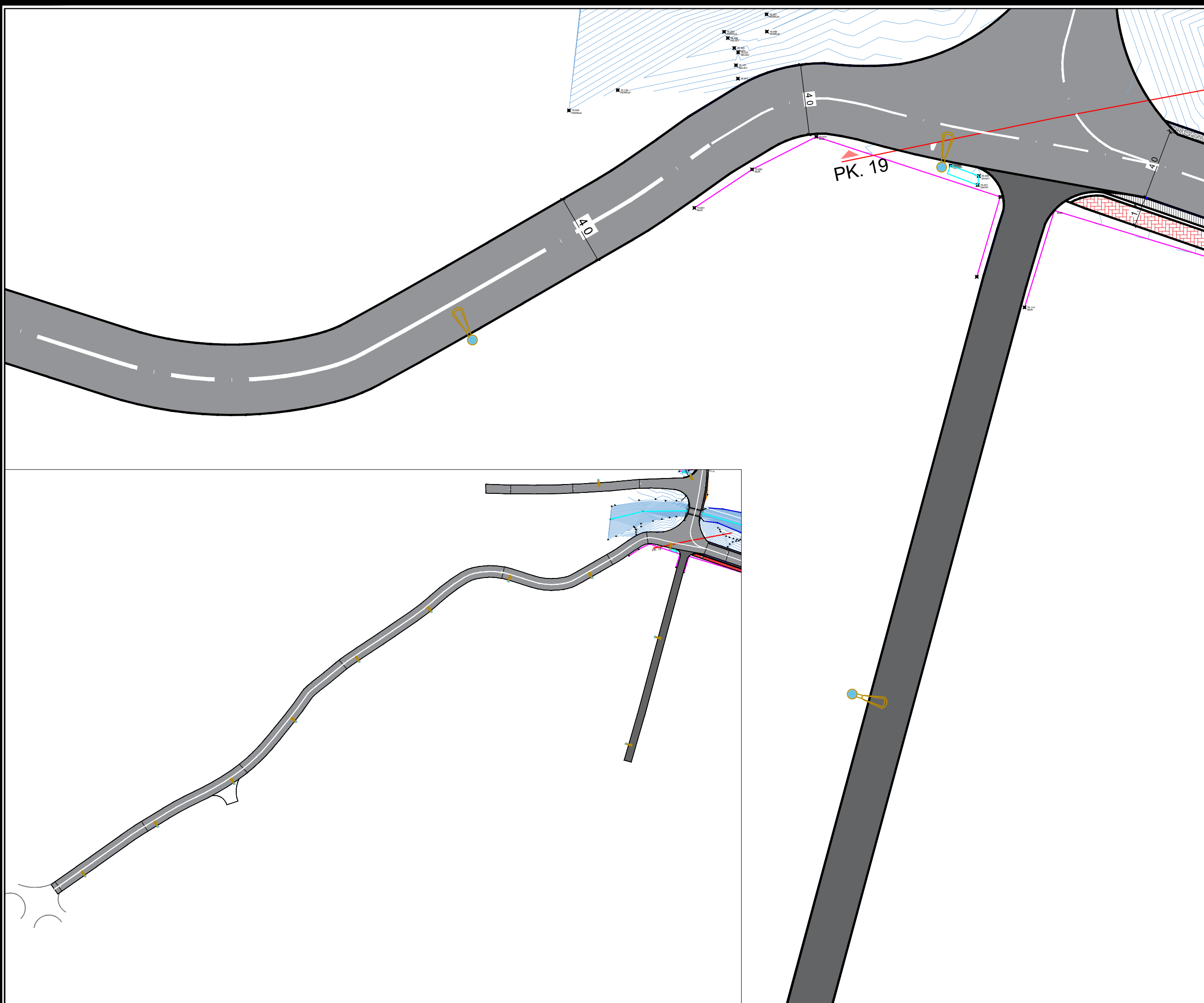



REPUBLIKA E SHQIPERISE
BASHKIA PATOS
DREJTORIA E PLANIFIKIMIT URBAN,
PROJEKTEVE, SHERBIMEVE DHE
EMERGJENCAVE CIVILE

EMERTIMI I PROJEKTIT:

**RIKONSTRUKSION I
RRUGES "LAGJJA E RE"
TEK PERROI CAM**

EMERTIMI I FLETES:

PLANIMETRIA E RRUGES

GRUPI I PROJEKTIMIT:

ING. SILVANA MICI
ARK. ARLIND RUSTO
ING EL.

DREJTORIA E PLANIFIKIMIT
URBAN, PROJEKTEVE,
SHERBIMEVE DHE
EMERGJENCAVE CIVILE

ING. BORETA MURATI

SHKALLA

1:200

Fleta: NR 11

KORRIK 2023

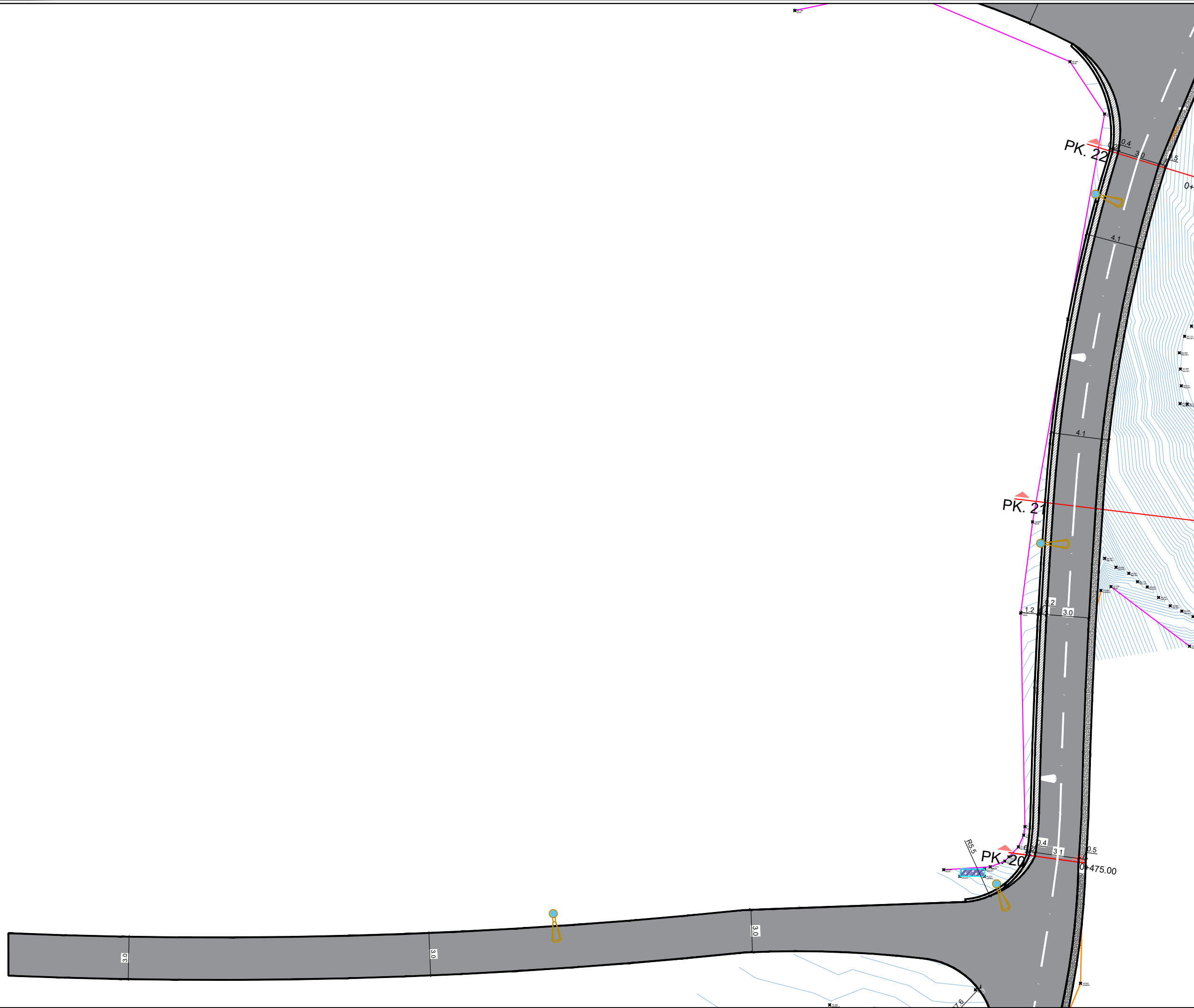



REPUBLIKA E SHQIPERISE
BASHKIA PATOS
DREJTORIA E PLANIFIKIMIT URBAN,
PROJEKTEVE, SHERBIMEVE DHE
EMERGJENCAVE CIVILE

EMERTIMI I PROJEKTIT:

**RIKONSTRUKSION I
RRUGES "LAGJJA E RE"
TEK PERROI CAM**

EMERTIMI I FLETES:

PLANIMETRIA E RRUGES

GRUPI I PROJEKTIMIT:

ING. SILVANA MICI
ARK. ARLIND RUSTO
ING EL.

DREJTORIA E PLANIFIKIMIT
URBAN, PROJEKTEVE,
SHERBIMEVE DHE
EMERGJENCAVE CIVILE

ING. BORETA MURATI

SHKALLA

1:200

Fleta: NR 12

KORRIK 2023

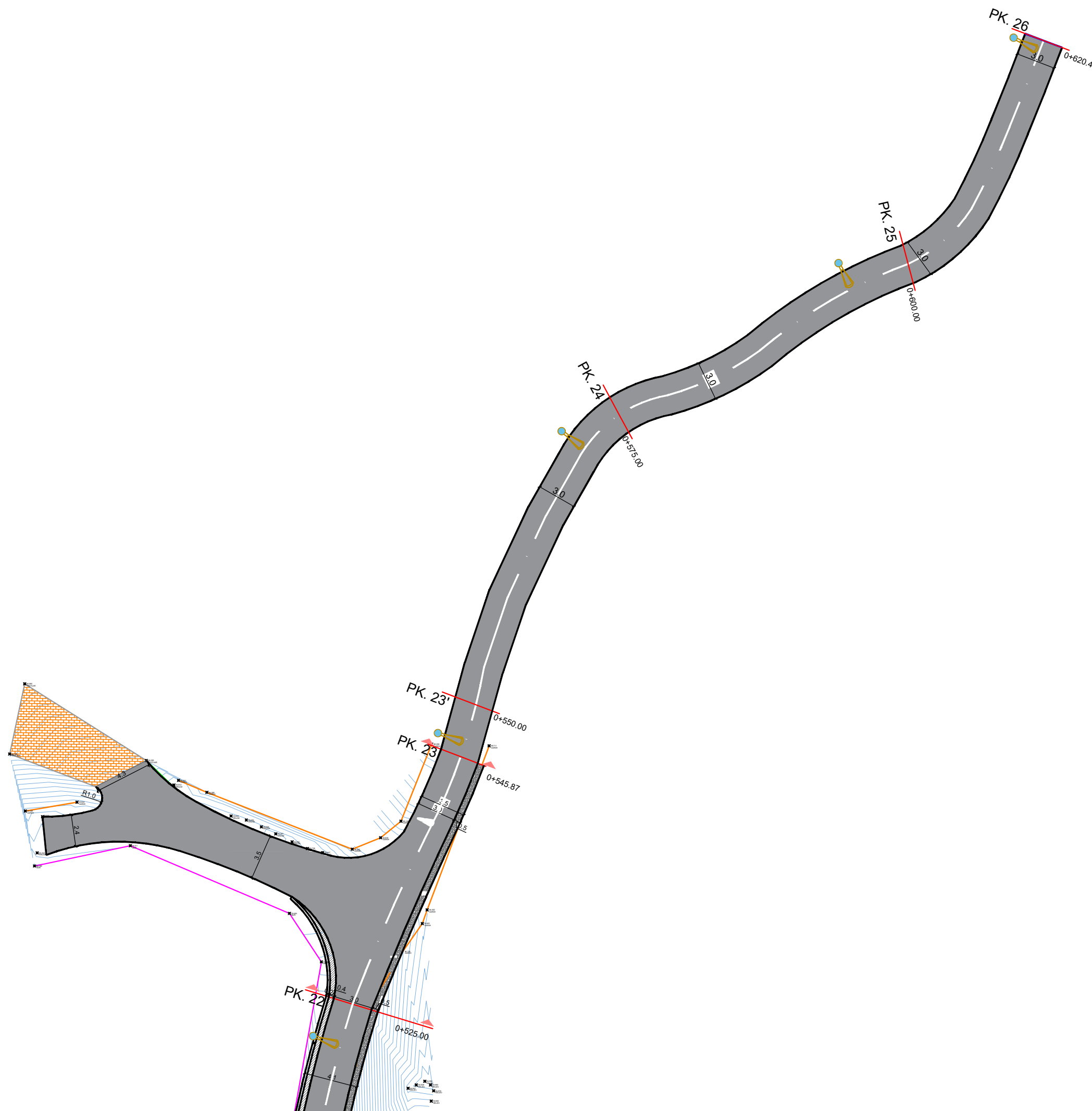



REPUBLIKA E SHQIPERISE
BASHKIA PATOS
DREJTORIA E PANIFIKIMIT URBAN, PROJEKTEVE, SHERBIMEVE DHE EMERGJENCAVE
CIVILE

OBJEKTI: RIKONSTRUKSION I RRUGES "LAGJJA E RE" TE PERROI ÇAM
PROFILAT TIP, TERTHOR DHE GJATESOR

Nr. i fleteve: 11 (njembedhete) flete

Grupi i Projektimit: **Ing. Top. Marsilda Kamberaj**
Ing. Silvana Mici
Ark. Arlind Rusto

Drejtore :

Ing. Boreta MURATI

MIRATOHET
KRYETAR
FATION DURO

Korrik 2023



REPUBLIKA E SHQIPERISE
BASHKIA PATOS
DREJTORIA E PLANIFIKIMIT URBAN,
PROJEKTEVE, SHERBIMEVE DHE
EMERGJENCAVE CIVILE

**PROFIL TERTHOR TIP
PIKETA 2-19**

EMERTIMI I PROJEKTIT:

**RIKONSTRUKSION I
RRUGES "LAGJJA E RE"
TEK PERROI CAM**

EMERTIMI I FLETES:

PROFILE TERTHOR TIP

GRUPI I PROJEKTIMIT:

ING. SILVANA MICI
ING.
ARK.
ING EL.

DREJTORIA E PLANIFIKIMIT
URBAN, PROJEKTEVE,
SHERBIMEVE DHE
EMERGJENCAVE CIVILE

ING. BORETA MURATI

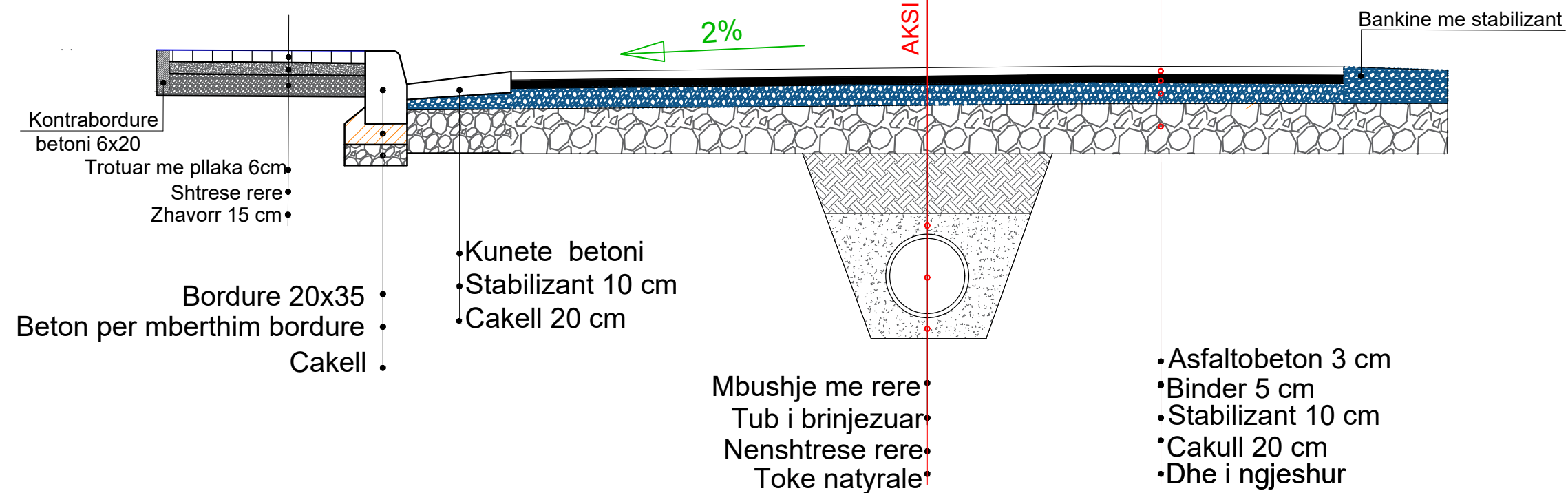
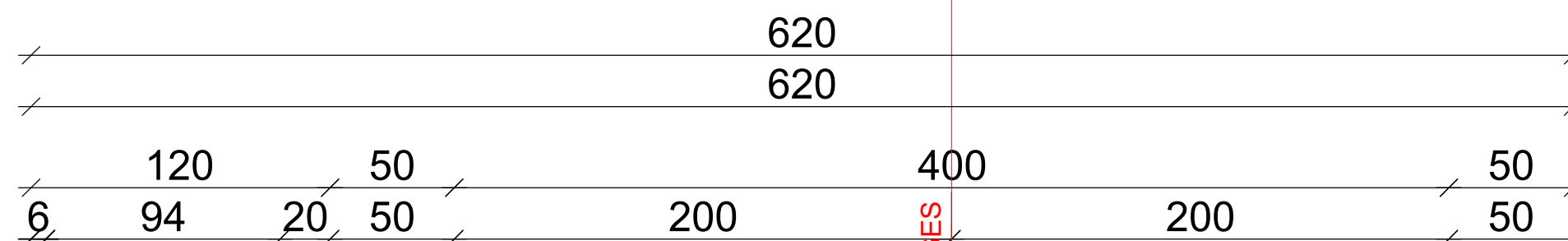

SHKALLA

1:25

Fleta: NR 1

KORRIK 2023



REPUBLIKA E SHQIPERISE
BASHKIA PATOS
DREJTORIA E PLANIFIKIMIT URBAN,
PROJEKTEVE, SHERBIMEVE DHE
EMERGJENCAVE CIVILE

**PROFIL TERTHOR TIP
PIKETA 20-22**

EMERTIMI I PROJEKTIT:

**RIKONSTRUKSION I
RRUGES "LAGJJA E RE"
TEK PERROI CAM**

EMERTIMI I FLETES:

PROFILE TERTHOR TIP

GRUPI I PROJEKTIMIT:

ING. SILVANA MICI
ING.
ARK.
ING EL.

DREJTORIA E PLANIFIKIMIT
URBAN, PROJEKTEVE,
SHERBIMEVE DHE
EMERGJENCAVE CIVILE

ING. BORETA MURATI

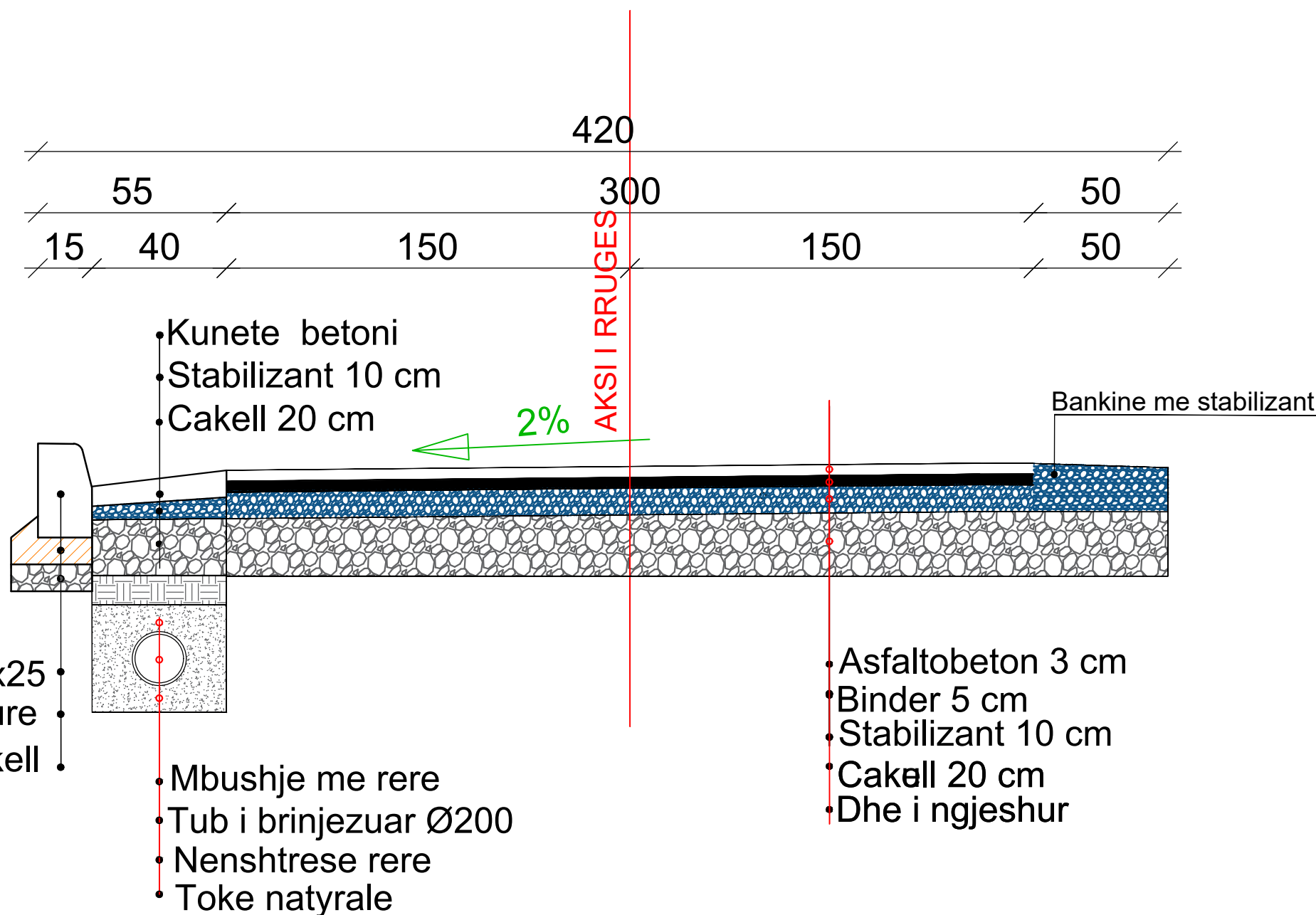

SHKALLA

1:20

Fleta: NR 2

KORRIK 2023



REPUBLIKA E SHQIPERISE
BASHKIA PATOS
DREJTORIA E PLANIFIKIMIT URBAN,
PROJEKTEVE, SHERBIMEVE DHE
EMERGJENCAVE CIVILE

EMERTIMI I PROJEKTIT:

RIKONSTRUKSION I
RRUGES "LAGJJA E RE"
TEK PERROI CAM

EMERTIMI I FLETES:

PROFILE TERTHOR TIP

GRUPI I PROJEKTIMIT:

ING. SILVANA MICI
ING.
ARK.
ING EL.

DREJTORIA E PLANIFIKIMIT
URBAN, PROJEKTEVE,
SHERBIMEVE DHE
EMERGJENCAVE CIVILE

ING. BORETA MURATI

SHKALLA

1:30

Fleta: NR 3

KORRIK 2023

PROFIL TERTHOR TIP
PIKETA 19- DEGEZIMI
POSHEM

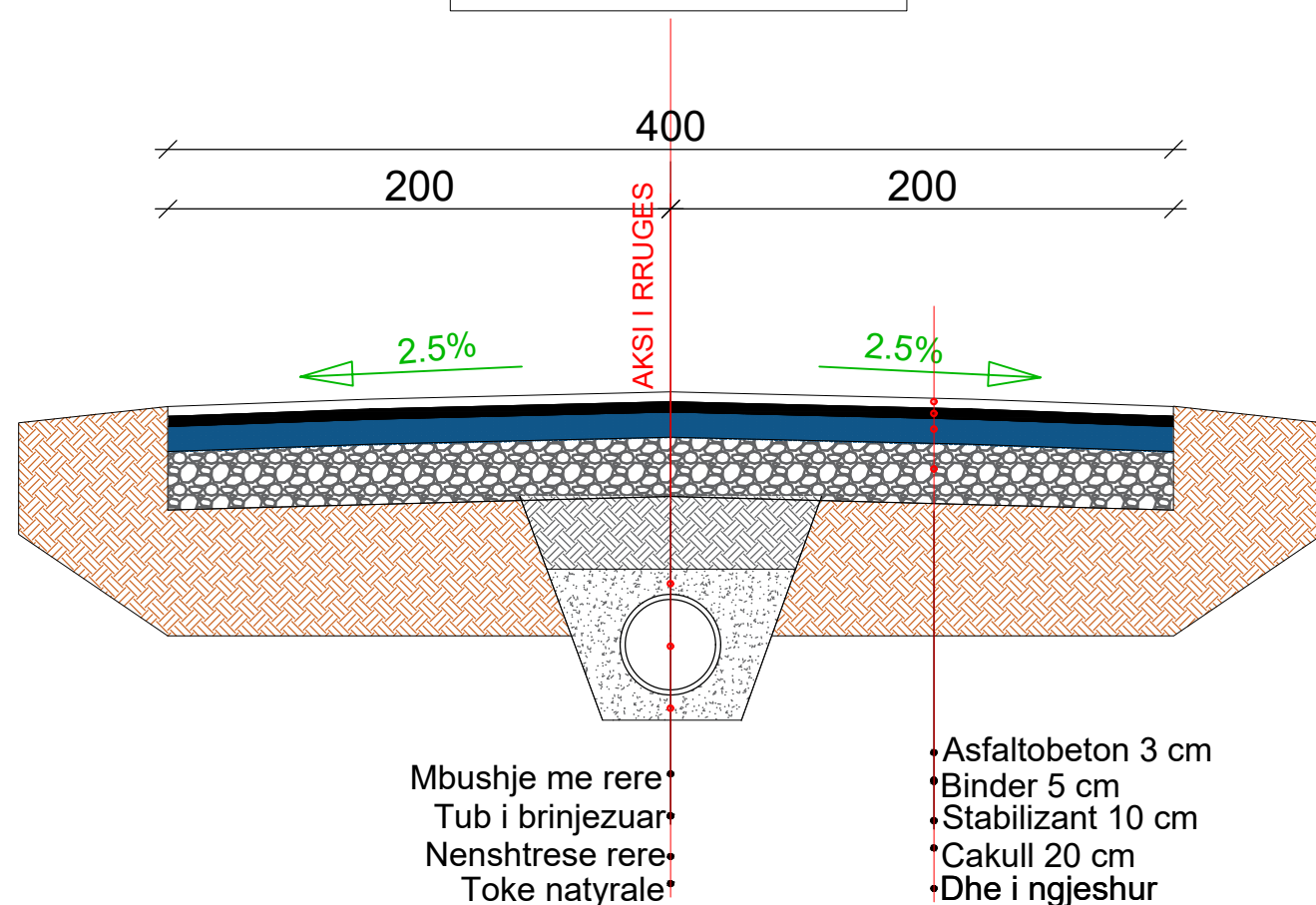

PROFIL TERTHOR TIP
PIKETA 23'-26

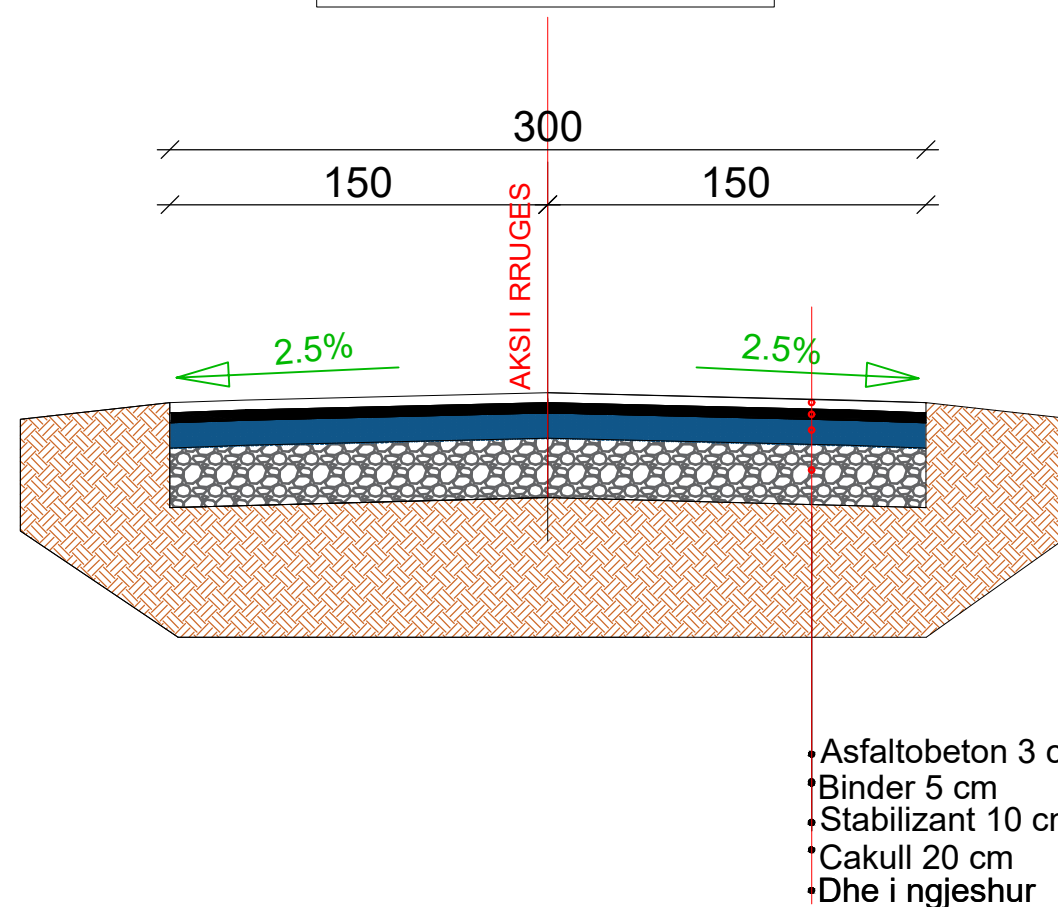



REPUBLIKA E SHQIPERISE
BASHKIA PATOS
DREJTORIA E PLANIFIKIMIT URBAN,
PROJEKTEVE, SHERBIMEVE DHE
EMERGJENCAVE CIVILE

EMERTIMI I PROJEKTIT:

**RIKONSTRUKSION I
RRUGES "LAGJJA E RE"
TEK PERROI CAM**

EMERTIMI I FLETES:

PROFILE TERTHORE

GRUPI I PROJEKTIMIT:

ING. SILVANA MICI
ING.
ARK.
ING EL.

DREJTORIA E PLANIFIKIMIT
URBAN, PROJEKTEVE,
SHERBIMEVE DHE
EMERGJENCAVE CIVILE

ING. BORETA MURATI

SHKALLA

1:250

Fleta: NR 4

KORRIK 2023

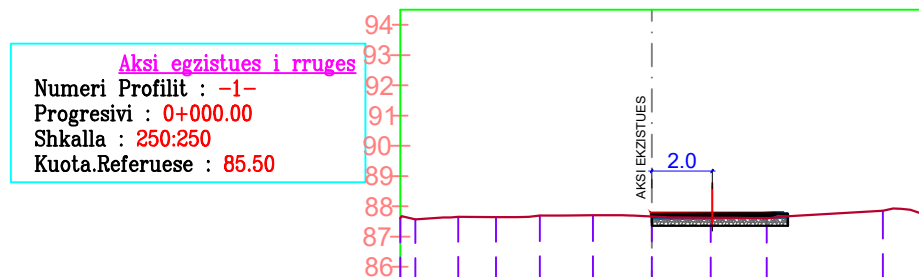

DIST.PROGRES.TERENIT

-4.46	-3.70	-2.92	-1.95	-0.63	0.00	0.63	1.95	2.77	3.80	4.36	7.64
-------	-------	-------	-------	-------	------	------	------	------	------	------	------

KUOTA E TERRENIT

87.64	87.69	87.69	87.70	87.69	87.66	87.63	87.62	87.62	87.60	87.66	87.86
-------	-------	-------	-------	-------	-------	-------	-------	-------	-------	-------	-------

Aksi egzistues i rruges
Numeri Profil : -2-
Progresivi : 0+025.00
Shkalla : 250:250
Kuota.Referuese : 82.50

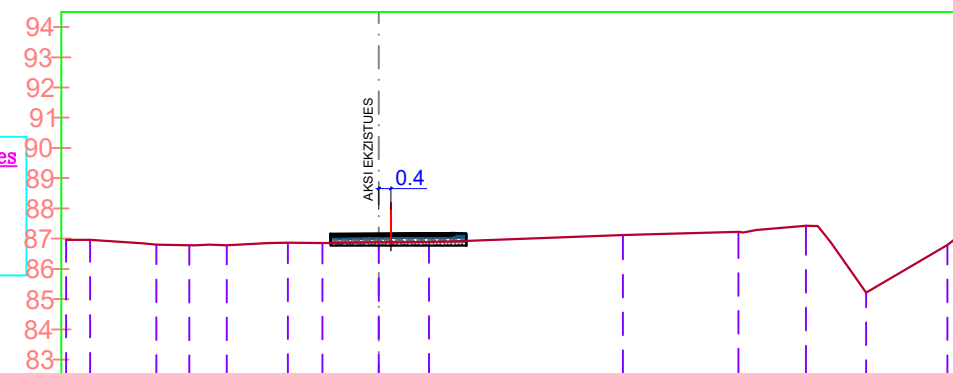

DIST.PROGRES.TERENIT

-7.36	-6.27	-5.62	-5.03	-3.64	-3.00	-1.86	0.00	0.51	1.66	2.42	8.07	11.89	12.45	14.13	14.94	16.11	18.80	19.54
-------	-------	-------	-------	-------	-------	-------	------	------	------	------	------	-------	-------	-------	-------	-------	-------	-------

KUOTA E TERRENIT

86.81	86.78	86.80	86.79	86.86	86.87	86.85	86.88	86.86	86.89	86.91	87.12	87.23	87.28	87.43	86.89	85.21	86.79	87.35
-------	-------	-------	-------	-------	-------	-------	-------	-------	-------	-------	-------	-------	-------	-------	-------	-------	-------	-------

Aksi egzistues i rruges
Numeri Profil : -3-
Progresivi : 0+050.00
Shkalla : 250:250
Kuota.Referuese : 82.50

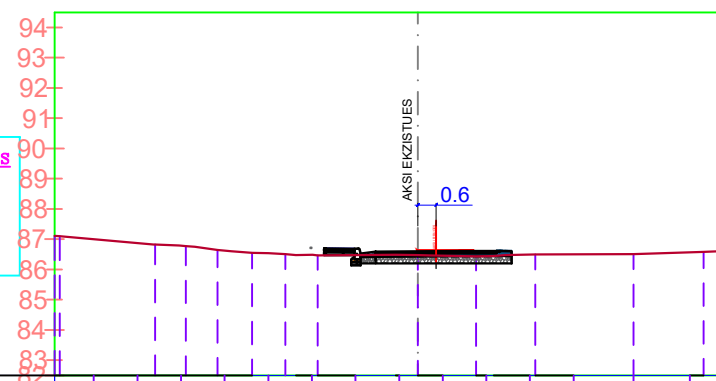

DIST.PROGRES.TERENIT

-7.90	-7.38	-6.18	-5.49	-4.95	-4.03	-3.32	-0.73	0.00	1.92	2.50	3.88	7.13	9.44	9.98
-------	-------	-------	-------	-------	-------	-------	-------	------	------	------	------	------	------	------

KUOTA E TERRENIT

86.79	86.75	86.61	86.55	86.53	86.48	86.47	86.49	86.47	86.43	86.44	86.50	86.51	86.58	86.60
-------	-------	-------	-------	-------	-------	-------	-------	-------	-------	-------	-------	-------	-------	-------

Aksi egzistues i rruges
Numeri Profil : -4-
Progresivi : 0+075.00
Shkalla : 250:250
Kuota.Referuese : 82.50

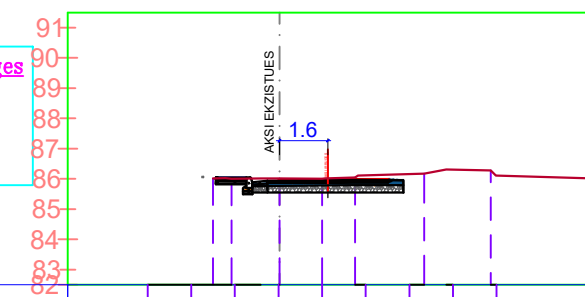

DIST.PROGRES.TERENIT

-2.20	-1.58	-0.62	0.00	1.41	2.50	4.78	5.52	6.99	11.09
-------	-------	-------	------	------	------	------	------	------	-------

KUOTA E TERRENIT

86.01	86.01	86.01	86.01	86.01	86.05	86.18	86.31	86.28	85.99
-------	-------	-------	-------	-------	-------	-------	-------	-------	-------



REPUBLIKA E SHQIPERISE
BASHKIA PATOS
DREJTORIA E PLANIFIKIMIT URBAN,
PROJEKTEVE, SHERBIMEVE DHE
EMERGJENCAVE CIVILE

EMERTIMI I PROJEKTIT:

**RIKONSTRUKSION I
RRUGES "LAGJJA E RE"
TEK PERROI CAM**

EMERTIMI I FLETES:

PROFILE TERTHORE

GRUPI I PROJEKTIMIT:

ING. SILVANA MICI
ING.
ARK.
ING EL.

DREJTORIA E PLANIFIKIMIT
URBAN, PROJEKTEVE,
SHERBIMEVE DHE
EMERGJENCAVE CIVILE

ING. BORETA MURATI

SHKALLA

1:250

Fleta: NR 5

KORRIK 2023

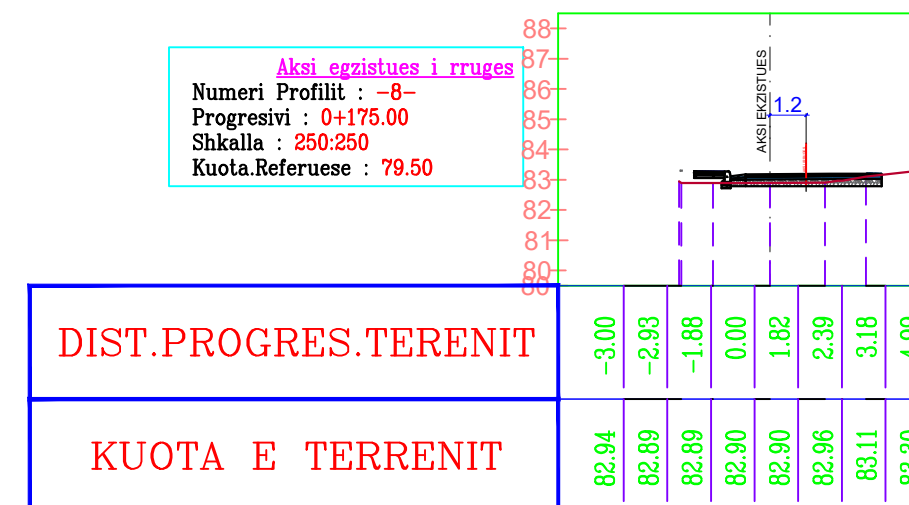
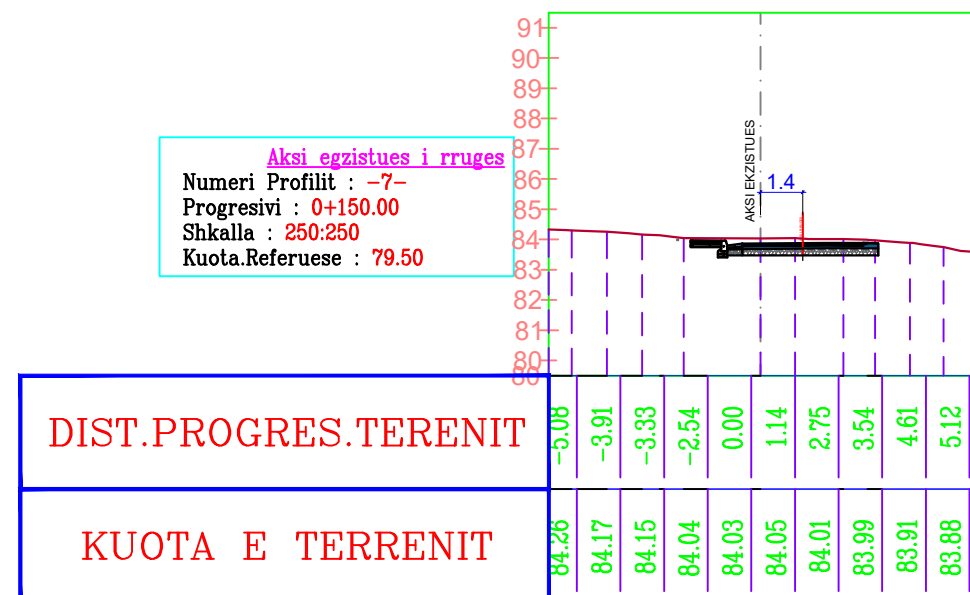
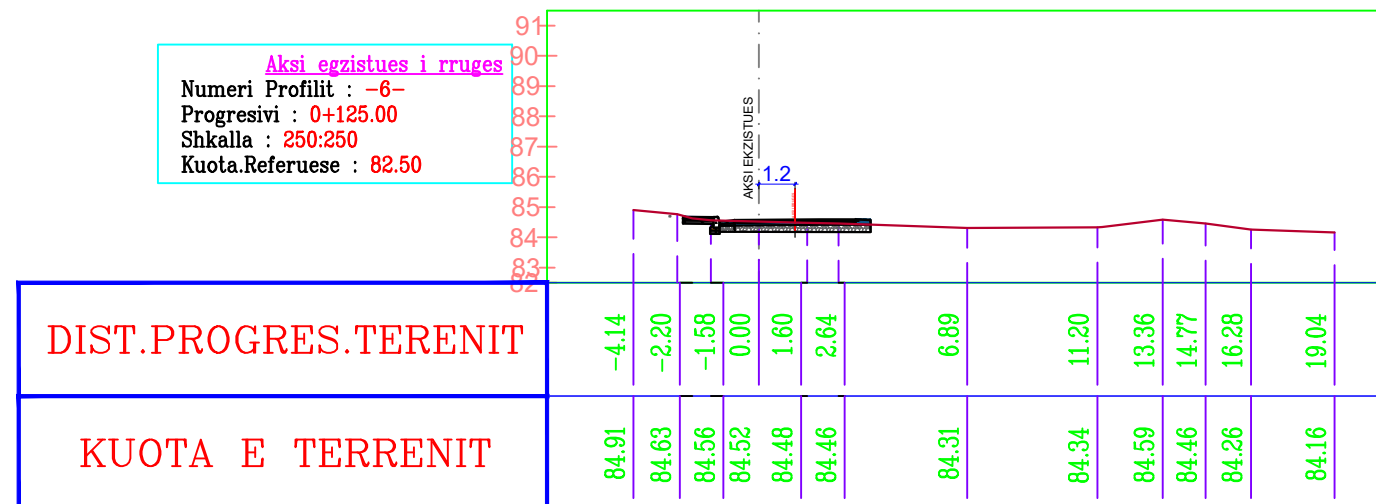
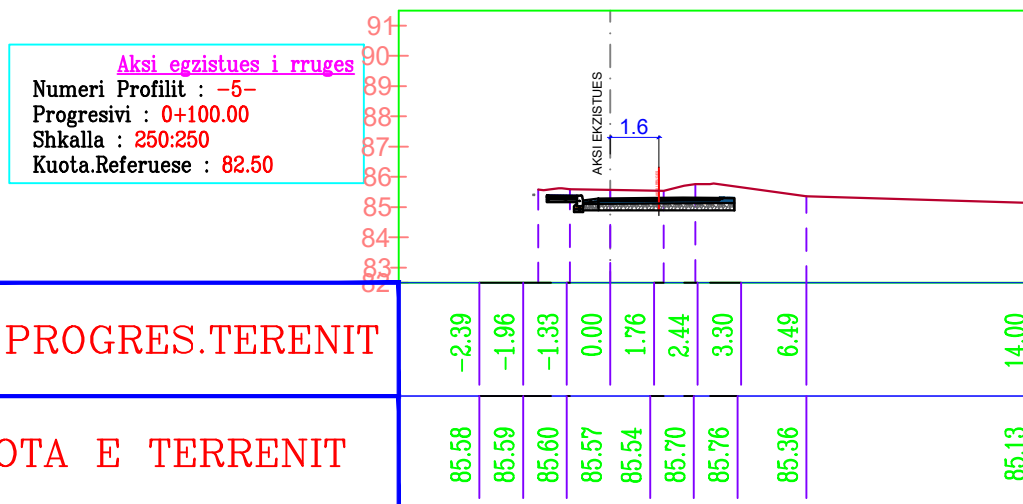



REPUBLIKA E SHQIPERISE
BASHKIA PATOS
DREJTORIA E PLANIFIKIMIT URBAN,
PROJEKTEVE, SHERBIMEVE DHE
EMERGJENCAVE CIVILE

EMERTIMI I PROJEKTIT:

**RIKONSTRUKSION I
RRUGES "LAGJJA E RE"
TEK PERROI CAM**

EMERTIMI I FLETES:

PROFILE TERTHORE

GRUPI I PROJEKTIMIT:

ING. SILVANA MICI
ING.
ARK.
ING EL.

DREJTORIA E PLANIFIKIMIT
URBAN, PROJEKTEVE,
SHERBIMEVE DHE
EMERGJENCAVE CIVILE

ING. BORETA MURATI

SHKALLA

1:250

Fleta: NR 6

KORRIK 2023

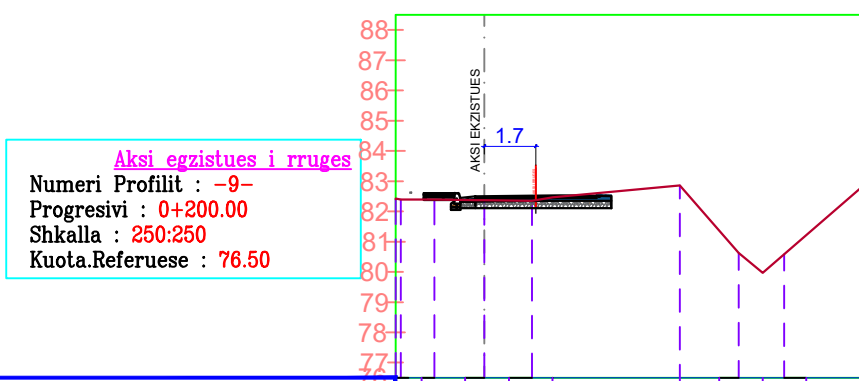

DIST.PROGRES.TERENIT	-1.00	0.00	1.58	2.26		6.46	8.41	9.20	9.91	12.59
KUOTA E TERRENIT	82.39	82.37	82.35	82.47		82.85	80.62	79.96	80.59	82.90

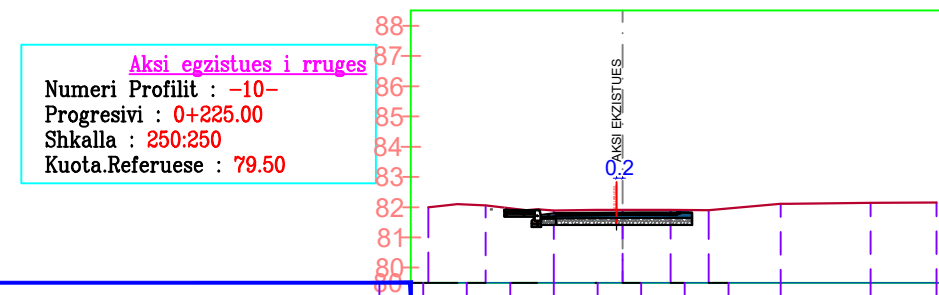

DIST.PROGRES.TERENIT	-5.45	-4.52	-2.82	-2.27	-0.90	0.00	1.59	2.85	5.23	8.20	10.38
KUOTA E TERRENIT	82.10	82.06	81.93	81.89	81.92	81.91	81.91	81.90	82.11	82.14	82.15

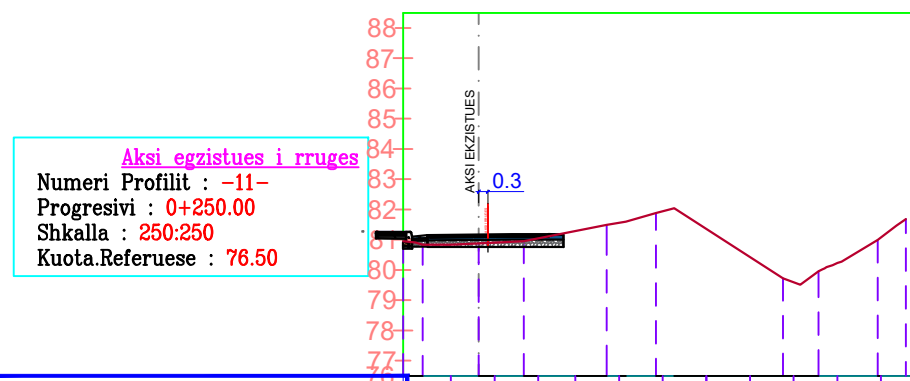

DIST.PROGRES.TERENIT	-0.92	0.00	1.49	4.24	4.86	5.86	10.06	10.63	11.23	11.86	13.19	13.81
KUOTA E TERRENIT	80.83	80.88	80.95	81.49	81.59	81.89	82.08	79.51	79.95	80.23	80.99	81.47

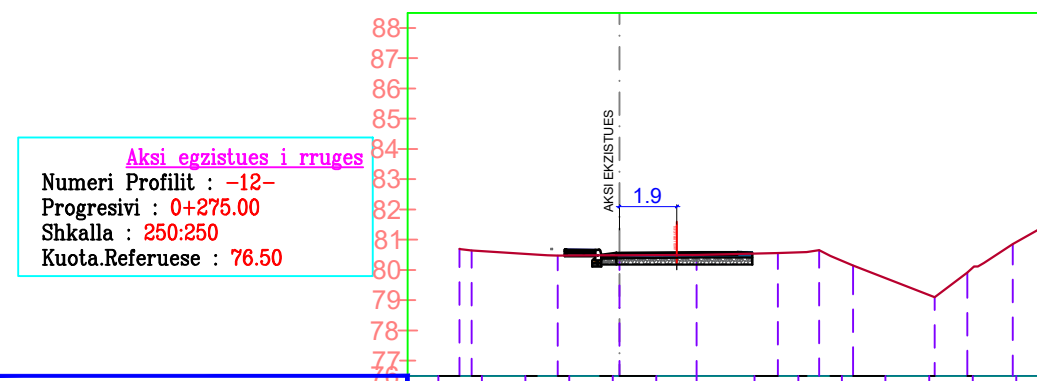

DIST.PROGRES.TERENIT	-5.28	-4.88	-2.73	-2.04	-0.64	0.00	2.56	5.24	6.19	6.98	7.73	10.42	11.50	12.06	13.00
KUOTA E TERRENIT	80.70	80.64	80.50	80.47	80.48	80.49	80.49	80.56	80.59	80.47	80.14	79.10	79.91	80.23	80.85



REPUBLIKA E SHQIPERISE
BASHKIA PATOS
DREJTORIA E PLANIFIKIMIT URBAN,
PROJEKTEVE, SHERBIMEVE DHE
EMERGJENCAVE CIVILE

EMERTIMI I PROJEKTIT:

**RIKONSTRUKSION I
RRUGES "LAGJJA E RE"
TEK PERROI CAM**

EMERTIMI I FLETES:

PROFILE TERTHORE

GRUPI I PROJEKTIMIT:

ING. SILVANA MICI
ING.
ARK.
ING EL.

DREJTORIA E PLANIFIKIMIT
URBAN, PROJEKTEVE,
SHERBIMEVE DHE
EMERGJENCAVE CIVILE

ING. BORETA MURATI

SHKALLA

1:250

Fleta: NR 7

KORRIK 2023

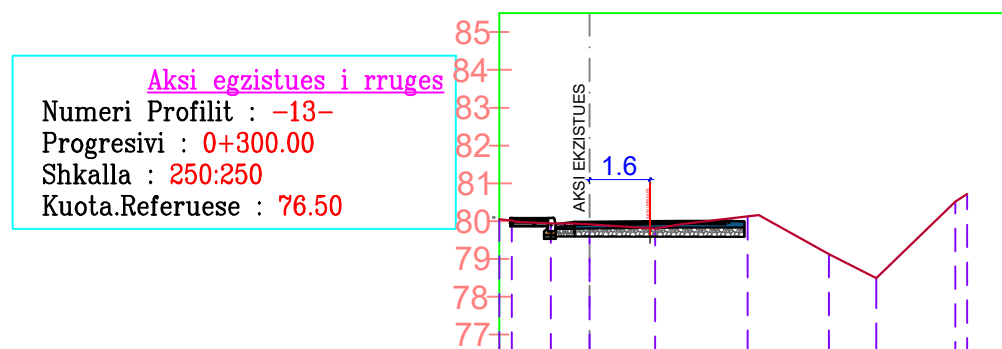

DIST.PROGRES.TERENIT	-1.03	0.00	1.74	2.45	4.18	6.33	7.58	9.68	9.99
KUOTA E TERRENIT	79.94	79.91	79.80	79.93	80.12	79.12	78.49	80.51	80.72

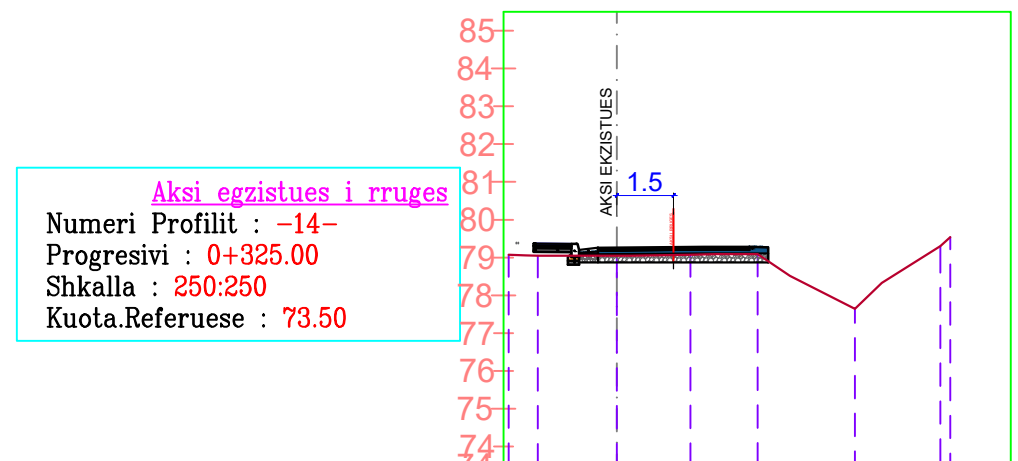

DIST.PROGRES.TERENIT	-2.09	0.00	1.95	2.63	3.72	4.57	6.29	7.00	8.55	8.82
KUOTA E TERRENIT	79.05	79.05	79.07	79.09	79.09	78.51	77.64	78.33	79.30	79.54

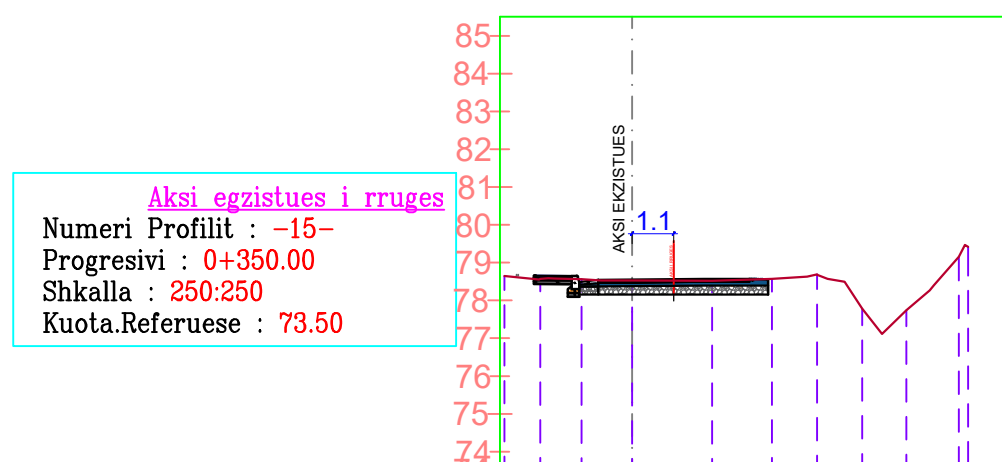

DIST.PROGRES.TERENIT	-1.34	-0.82	0.00	2.12	3.70	4.63	5.17	6.09	6.61	7.26
KUOTA E TERRENIT	78.56	78.53	78.53	78.52	78.57	78.63	78.57	77.78	77.11	77.74

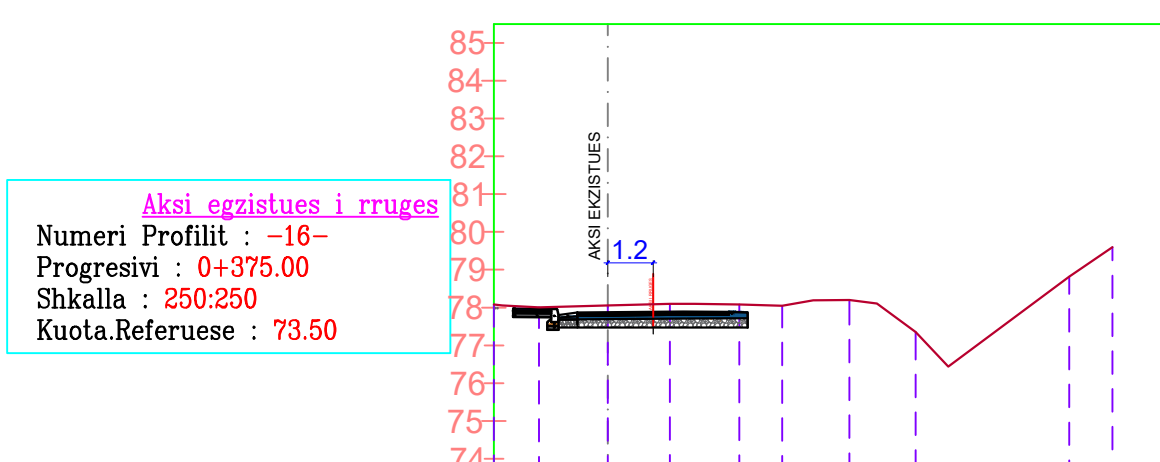

DIST.PROGRES.TERENIT	-2.79	-1.82	0.00	1.65	2.30	3.48	4.62	5.44	6.40	7.12	8.14	9.01	12.21	13.35
KUOTA E TERRENIT	78.05	78.01	78.05	78.10	78.10	78.08	78.05	78.19	78.20	78.10	77.35	76.44	78.82	79.59



REPUBLIKA E SHQIPERISE
BASHKIA PATOS
DREJTORIA E PLANIFIKIMIT URBAN,
PROJEKTEVE, SHERBIMEVE DHE
EMERGJENCAVE CIVILE

EMERTIMI I PROJEKTIT:

**RIKONSTRUKSION I
RRUGES "LAGJJA E RE"
TEK PERROI CAM**

EMERTIMI I FLETES:

PROFILE TERTHORE

GRUPI I PROJEKTIMIT:

ING. SILVANA MICI
ING.
ARK.
ING EL.

DREJTORIA E PLANIFIKIMIT
URBAN, PROJEKTEVE,
SHERBIMEVE DHE
EMERGJENCAVE CIVILE

ING. BORETA MURATI

SHKALLA

1:250

Fleta: NR 8

KORRIK 2023

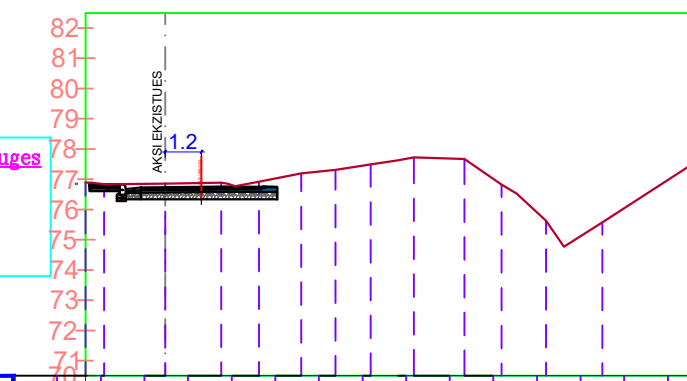

DIST.PROGRES.TERENIT

KUOTA E TERRENIT

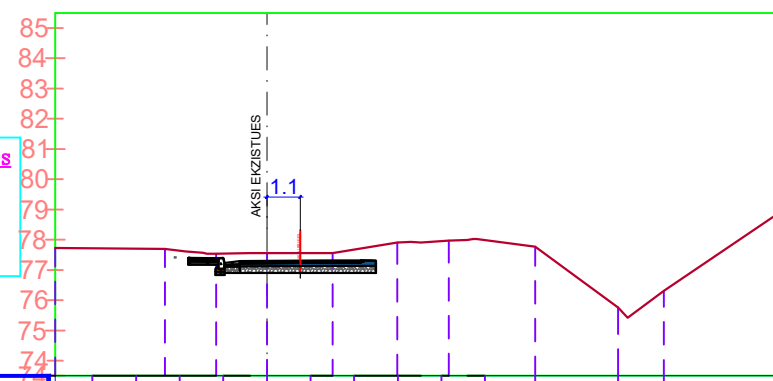

DIST.PROGRES.TERENIT

KUOTA E TERRENIT

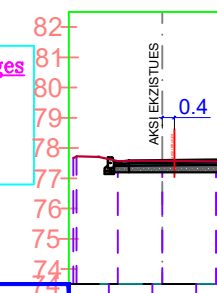

DIST.PROGRES.TERENIT

KUOTA E TERRENIT

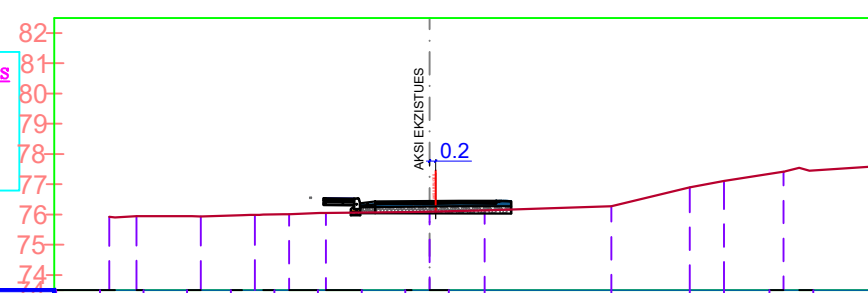

DIST.PROGRES.TERENIT

KUOTA E TERRENIT



REPUBLIKA E SHQIPERISE
BASHKIA PATOS
DREJTORIA E PLANIFIKIMIT URBAN,
PROJEKTEVE, SHERBIMEVE DHE
EMERGJENCAVE CIVILE

EMERTIMI I PROJEKTIT:

**RIKONSTRUKSION I
RRUGES "LAGJJA E RE"
TEK PERROI CAM**

EMERTIMI I FLETES:

PROFILE TERTHORE

GRUPI I PROJEKTIMIT:

ING. SILVANA MICI
ING.
ARK.
ING EL.

DREJTORIA E PLANIFIKIMIT
URBAN, PROJEKTEVE,
SHERBIMEVE DHE
EMERGJENCAVE CIVILE

ING. BORETA MURATI

SHKALLA

1:250

Fleta: NR 9

KORRIK 2023

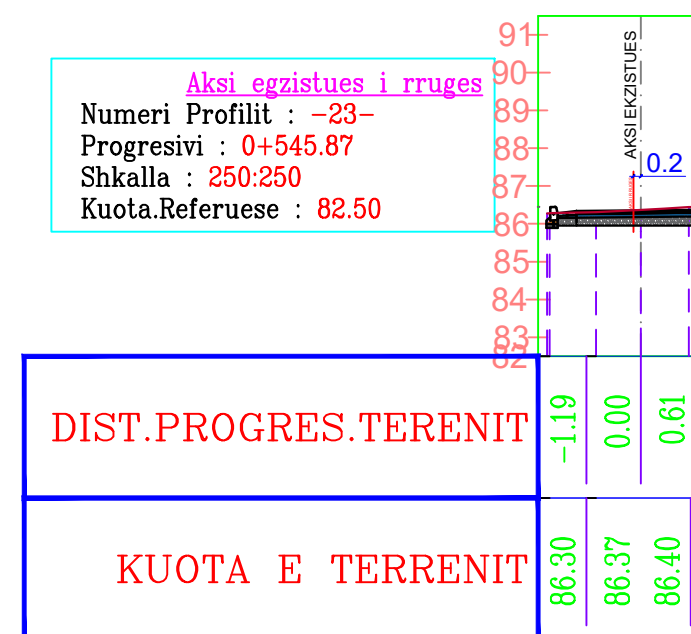
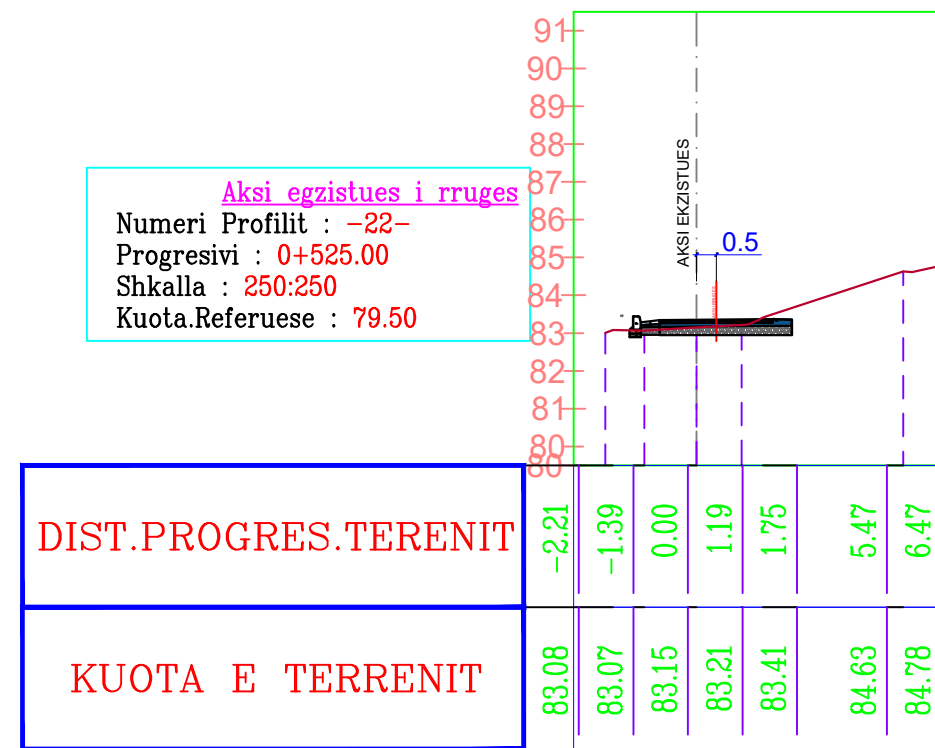
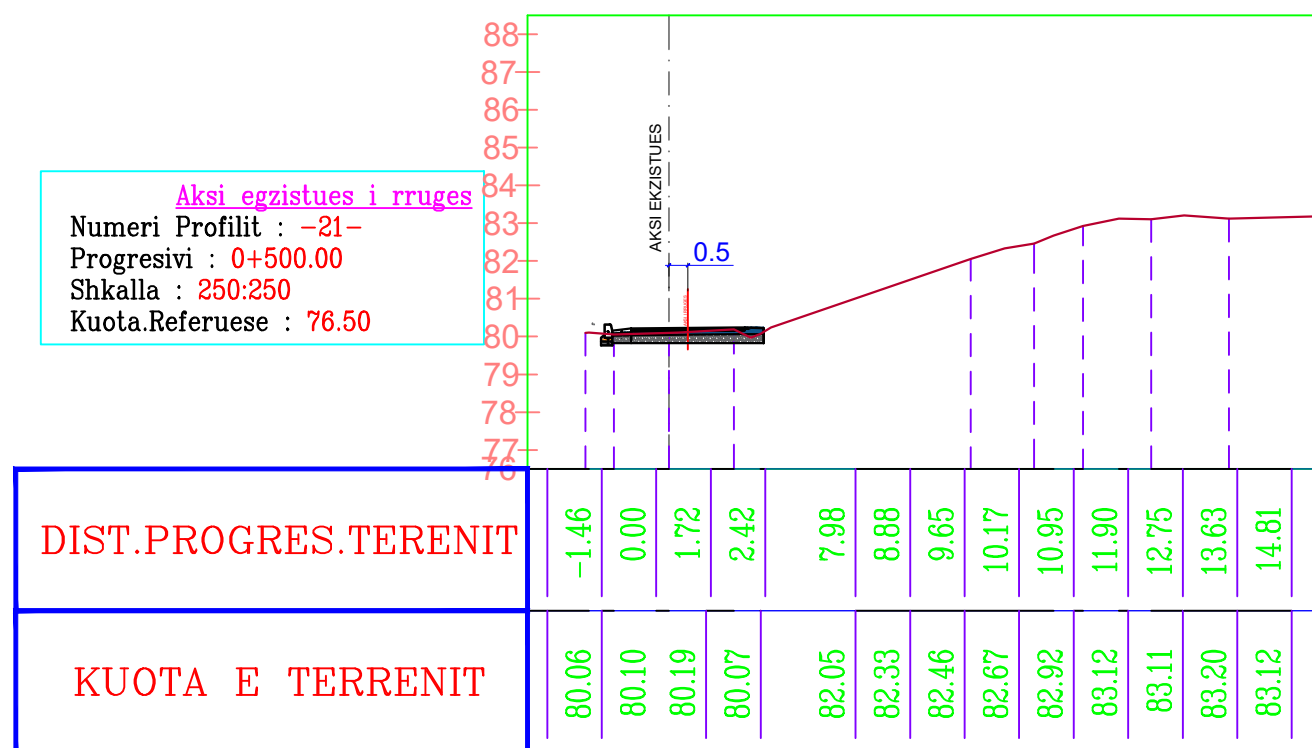



REPUBLIKA E SHQIPERISE
BASHKIA PATOS
DREJTORIA E PLANIFIKIMIT URBAN,
PROJEKTEVE, SHERBIMEVE DHE
EMERGJENCAVE CIVILE

EMERTIMI I PROJEKTIT:

**RIKONSTRUKSION I
RRUGES "LAGJJA E RE"
TEK PERROI CAM**

EMERTIMI I FLETES:

PROFILI GJATESOR

GRUPI I PROJEKTIMIT:

ING. SILVANA MICI
ING.
ARK.
ING EL.

DREJTORIA E PLANIFIKIMIT
URBAN, PROJEKTEVE,
SHERBIMEVE DHE
EMERGJENCAVE CIVILE

ING. BORETA MURATI

NIVELETA

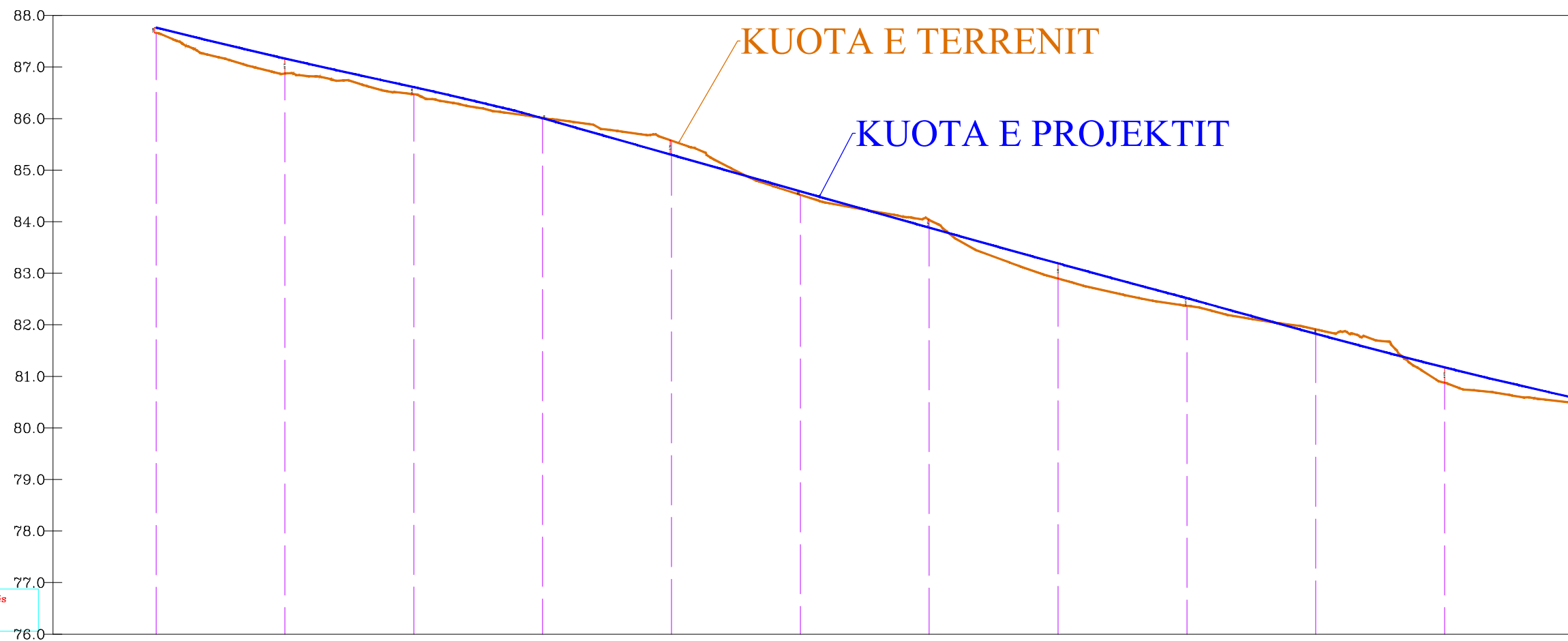

Profili : Profili gjatesor i rruges
Shkalla : 250:25
Kuota Ref : 76.00

DISTANCA PJESORE		25.00	25.00	25.00	25.00	25.00	25.00	25.00	25.00	25.00	25.00	25.00	25.00	25.00	25.00
DISTANCA PROGRESIVE		0+000.00	0+025.00	0+050.00	0+075.00	0+100.00	0+125.00	0+150.00	0+175.00	0+200.00	0+225.00	0+250.00	0+275.00		
NUMERI PROFILIEVE		Sc-1	Sc-2	Sc-3	Sc-4	Sc-5	Sc-6	Sc-7	Sc-8	Sc-9	Sc-10	Sc-11	Sc-12		
KUOTA E TERRENIT		87.66	86.88	86.47	86.01	85.57	84.52	84.03	82.90	82.37	81.91	80.88	80.49		
KUOTA E PROJEKTIT		87.76	87.17	86.61	85.96	85.30	84.59	83.88	83.20	82.52	81.82	81.18	80.59		
MBUSHJE		-0.10	-0.29	-0.14			-0.07		-0.30	-0.15		0.30	0.10		
GERMIM					0.05	0.27		0.15			0.09				
KILOMETRAZHI		[Scale bar showing 0 to 275 meters]													

SHKALLA

1:100

Fleta: NR 10

KORRIK 2023



REPUBLIKA E SHQIPERISE
 BASHKIA PATOS
 DREJTORIA E PLANIFIKIMIT URBAN,
 PROJEKTEVE, SHERBIMEVE DHE
 EMERGJENCAVE CIVILE

EMERTIMI I PROJEKTIT:

**RIKONSTRUKSION I
 RRUGES "LAGJJA E RE"
 TEK PERROI CAM**

EMERTIMI I FLETES:

PROFILI GJATESOR

GRUPI I PROJEKTIMIT:

ING. SILVANA MICI
 ING.
 ARK.
 ING EL.

DREJTORIA E PLANIFIKIMIT
 URBAN, PROJEKTEVE,
 SHERBIMEVE DHE
 EMERGJENCAVE CIVILE

ING. BORETA MURATI

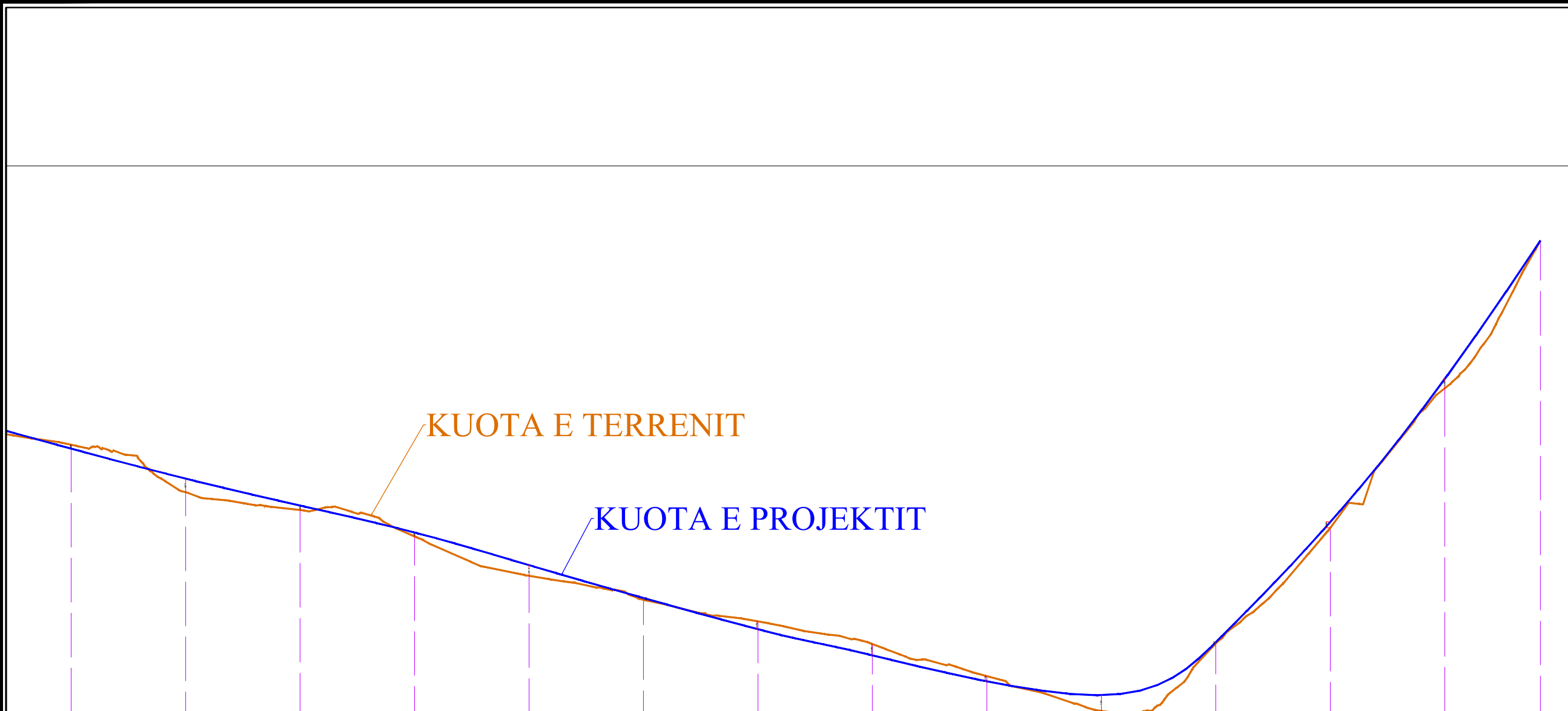

25,00	25,00	25,00	25,00	25,00	25,00	25,00	25,00	25,00	25,00	25,00	25,00	25,00	25,00	25,00	20,87
81.82	81.18	80.59	80.00	79.28	78.57	77.88	77.31	76.86	76.45	77.60	80.23	83.36	86.37		
81.91	80.88	80.49	79.91	79.05	78.53	78.05	77.56	76.86	76.10	77.57	80.10	83.15	86.37		
Sc-10	Sc-11	Sc-12	Sc-13	Sc-14	Sc-15	Sc-16	Sc-17	Sc-18	Sc-19	Sc-20	Sc-21	Sc-22	Sc-23		
0+225.00	0+250.00	0+275.00	0+300.00	0+325.00	0+350.00	0+375.00	0+400.00	0+425.00	0+450.00	0+475.00	0+500.00	0+525.00	0+545.87		
0.09	0.30	0.10	0.09	0.23	0.04	0.17	0.25	0.11	0.35	0.03	0.13	0.21	0.00		

SHKALLA

1:100

Fleta: NR 11

KORRIK 2023



REPUBLIKA E SHQIPERISE
BASHKIA PATOS
DREJTORIA E PANIFIKIMIT URBAN, PROJEKTEVE, SHERBIMEVE DHE EMERGJENCAVE
CIVILE

OBJEKTI: RIKONSTRUKSION I RRUGES "LAGJJA E RE" TE PERROI ÇAM

PLANI I KANALIZIMEVE

Nr. i fleteve: 10 (dhjete) flete

Grupi i Projektimit: **Ing. Silvana Mici**
Ark. Arlind Rusto

Drejtor : **Ing. Boreta MURATI**

MIRATOHET
KRYETAR
FATION DURO

Korrik 2023



REPUBLIKA E SHQIPERISE
BASHKIA PATOS
DREJTORIA E PLANIFIKIMIT URBAN,
PROJEKTEVE, SHERBIMEVE DHE
EMERGJENCAVE CIVILE

EMERTIMI I PROJEKTIT:

**RIKONSTRUKSION I
RRUGES "LAGJJA E RE"
TEK PERROI CAM**

EMERTIMI I FLETES:

**PLANI I KANALIZIMEVE TE
UJRAVE**

GRUPI I PROJEKTIMIT:

ING. SILVANA MICI
ING.
ARK.
ING EL.

DREJTORIA E PLANIFIKIMIT
URBAN, PROJEKTEVE,
SHERBIMEVE DHE
EMERGJENCAVE CIVILE

ING. BORETA MURATI

SHKALLA

1:300

Fleta: NR 1

KORRIK 2023

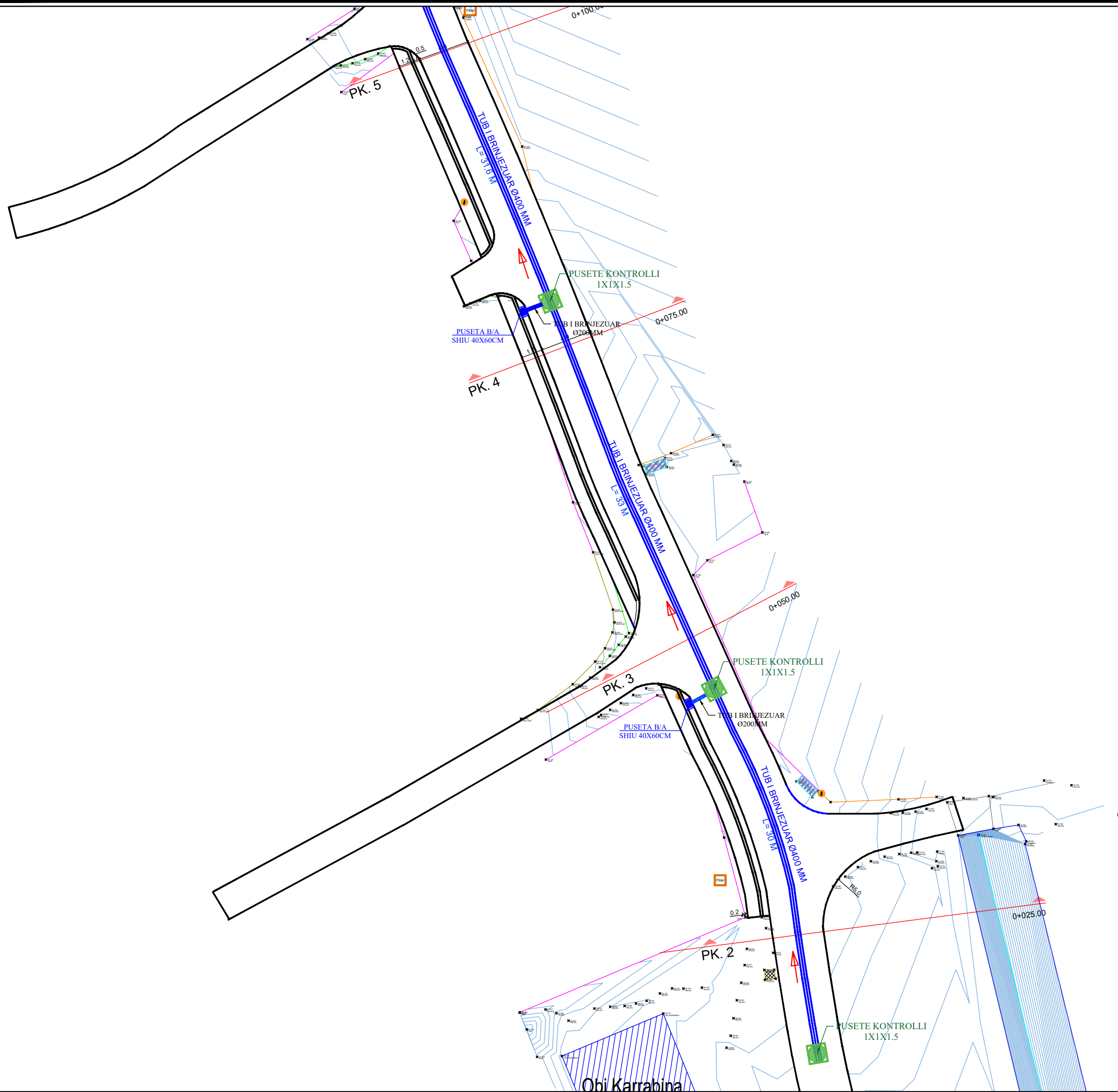



REPUBLIKA E SHQIPERISE
BASHKIA PATOS
DREJTORIA E PLANIFIKIMIT URBAN,
PROJEKTEVE, SHERBIMEVE DHE
EMERGJENCAVE CIVILE

EMERTIMI I PROJEKTIT:

**RIKONSTRUKSION I
RRUGES "LAGJJA E RE"
TEK PERROI CAM**

EMERTIMI I FLETES:

**PLANI I KANALIZIMEVE TE
UJRAVE**

GRUPI I PROJEKTIMIT:

ING. SILVANA MICI
ING.
ARK.
ING EL.

DREJTORIA E PLANIFIKIMIT
URBAN, PROJEKTEVE,
SHERBIMEVE DHE
EMERGJENCAVE CIVILE

ING. BORETA MURATI

SHKALLA

1:300

Fleta: NR 2

KORRIK 2023

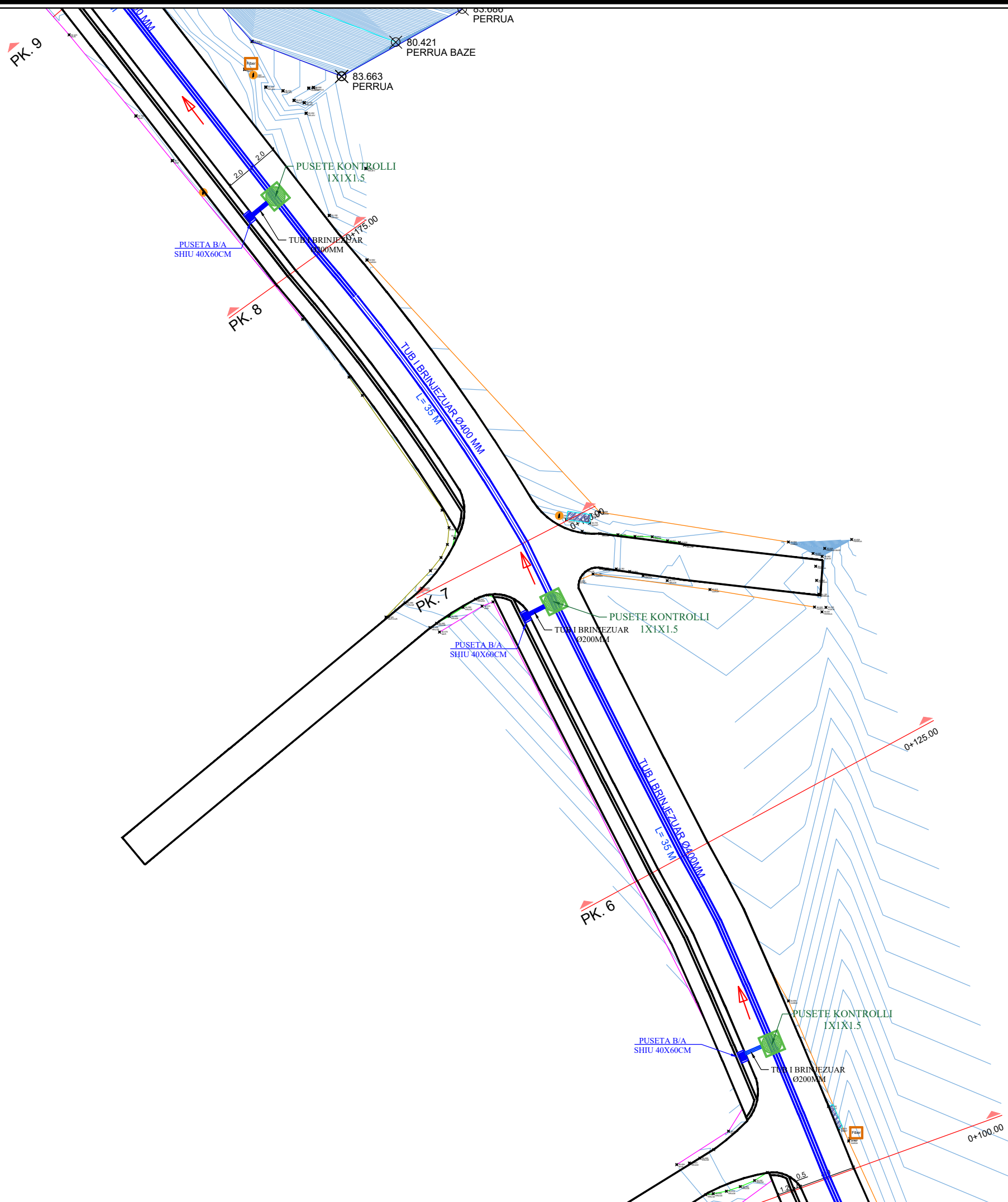



REPUBLIKA E SHQIPERISE
BASHKIA PATOS
DREJTORIA E PLANIFIKIMIT URBAN,
PROJEKTEVE, SHERBIMEVE DHE
EMERGJENCAVE CIVILE

EMERTIMI I PROJEKTIT:

**RIKONSTRUKSION I
RRUGES "LAGJJA E RE"
TEK PERROI CAM**

EMERTIMI I FLETES:

**PLANI I KANALIZIMEVE TE
UJRAVE**

GRUPI I PROJEKTIMIT:

ING. SILVANA MICI
ING.
ARK.
ING EL.

DREJTORIA E PLANIFIKIMIT
URBAN, PROJEKTEVE,
SHERBIMEVE DHE
EMERGJENCAVE CIVILE

ING. BORETA MURATI

SHKALLA

1:300

Fleta: NR 3

KORRIK 2023

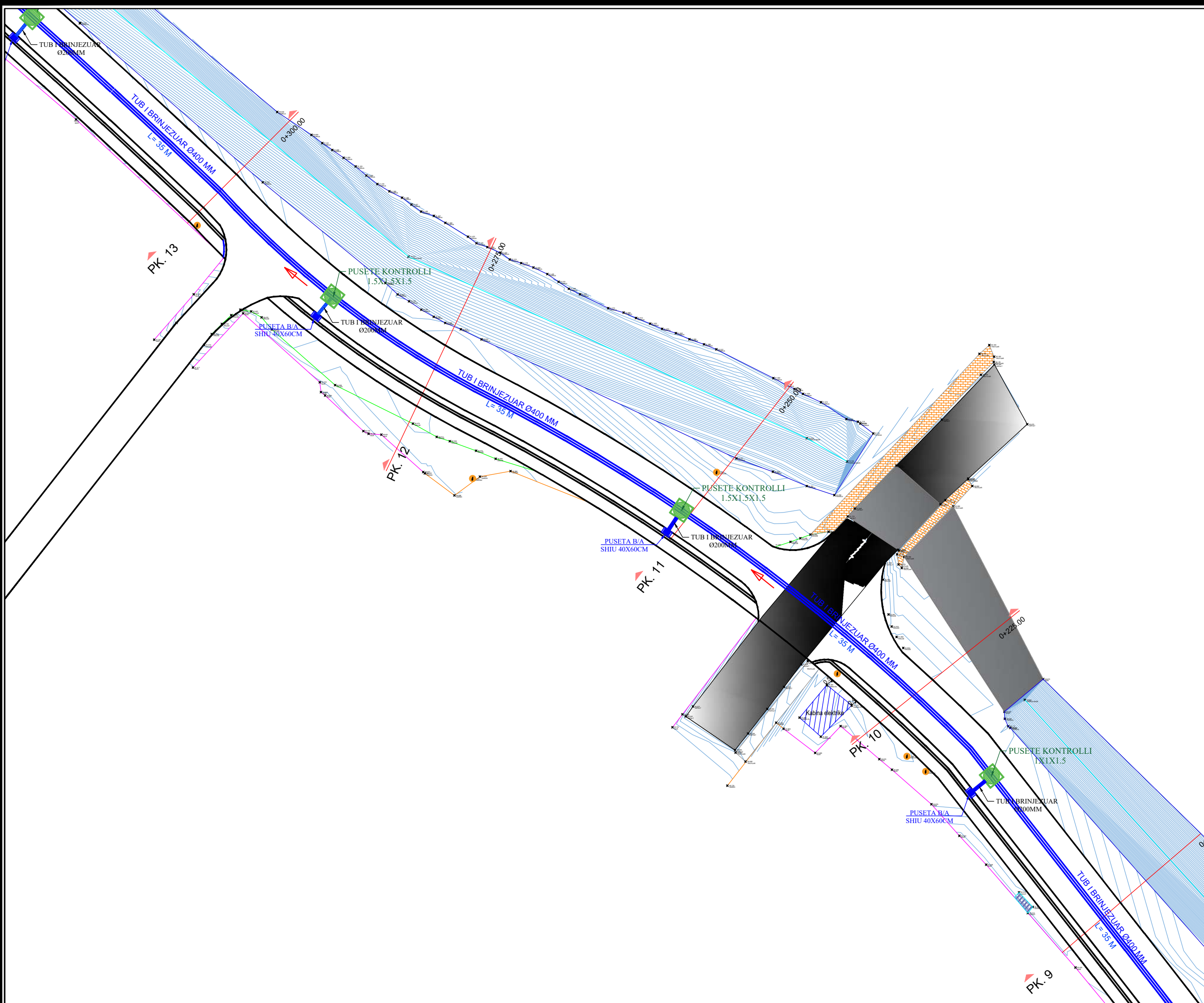



REPUBLIKA E SHQIPERISE
BASHKIA PATOS
DREJTORIA E PLANIFIKIMIT URBAN,
PROJEKTEVE, SHERBIMEVE DHE
EMERGJENCAVE CIVILE

EMERTIMI I PROJEKTIT:

**RIKONSTRUKSION I
RRUGES NE' ENJERNE
RETERERENHOCIAM**

EMERTIMI I FLETES:

**PLANI I KANALIZIMEVE TE
UJRAVE**

GRUPI I PROJEKTIMIT:

ING. SILVANA MICI
ING.
ARK.
ING EL.

DREJTORIA E PLANIFIKIMIT
URBAN, PROJEKTEVE,
SHERBIMEVE DHE
EMERGJENCAVE CIVILE

ING. BORETA MURATI

SHKALLA

1:300

Fleta: NR 4

KORRIK 2023

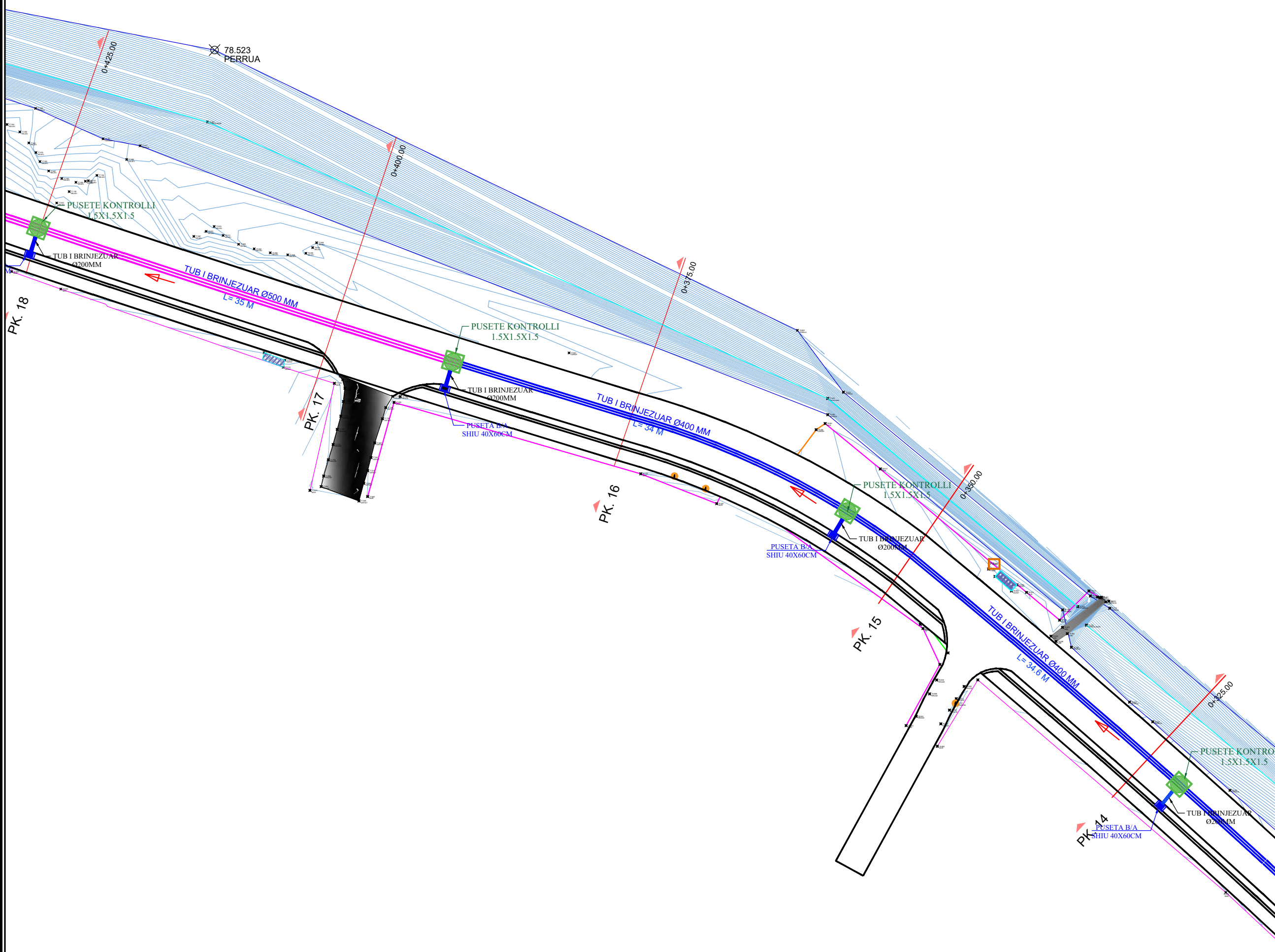



REPUBLIKA E SHQIPERISE
BASHKIA PATOS
DREJTORIA E PLANIFIKIMIT URBAN,
PROJEKTEVE, SHERBIMEVE DHE
EMERGJENCAVE CIVILE

EMERTIMI I PROJEKTIT:

**RIKONSTRUKSION I
RRUGES "LAGJJA E RE"
TEK PERROI CAM**

EMERTIMI I FLETES:

**PLANI I KANALIZIMEVE TE
UJRAVE**

GRUPI I PROJEKTIMIT:

ING. SILVANA MICI
ING.
ARK.
ING EL.

DREJTORIA E PLANIFIKIMIT
URBAN, PROJEKTEVE,
SHERBIMEVE DHE
EMERGJENCAVE CIVILE

ING. BORETA MURATI

SHKALLA

1:300

Fleta: NR 5

KORRIK 2023

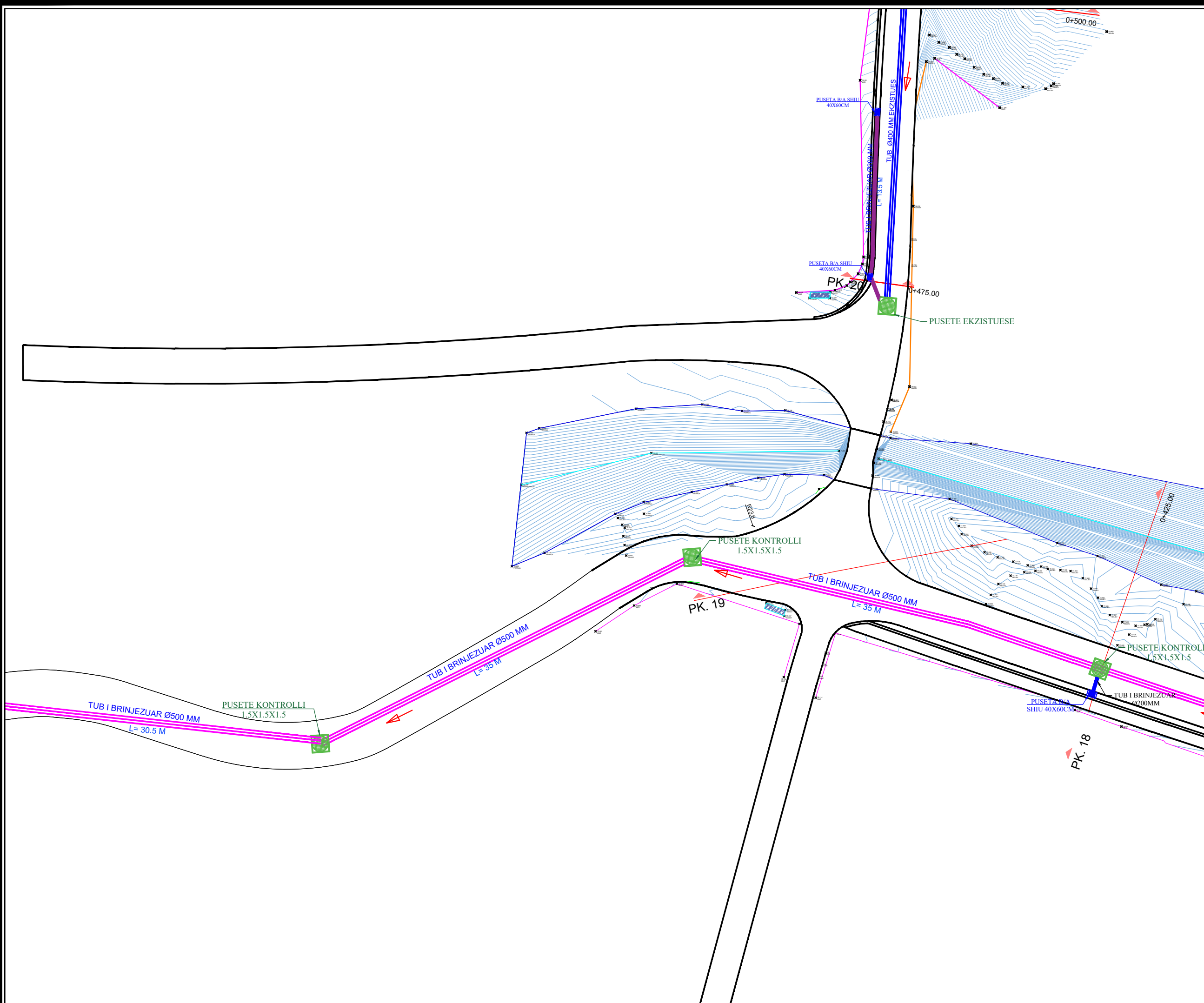



REPUBLIKA E SHQIPERISE
BASHKIA PATOS
DREJTORIA E PLANIFIKIMIT URBAN,
PROJEKTEVE, SHERBIMEVE DHE
EMERGJENCAVE CIVILE

EMERTIMI I PROJEKTIT:

**RIKONSTRUKSION I
RRUGES "LAGJJA E RE"
TEK PERROI CAM**

EMERTIMI I FLETES:

**PLANI I KANALIZIMEVE TE
UJRAVE**

GRUPI I PROJEKTIMIT:

ING. SILVANA MICI
ING.
ARK.
ING EL.

DREJTORIA E PLANIFIKIMIT
URBAN, PROJEKTEVE,
SHERBIMEVE DHE
EMERGJENCAVE CIVILE

ING. BORETA MURATI

SHKALLA

1:300

Fleta: NR 6

KORRIK 2023

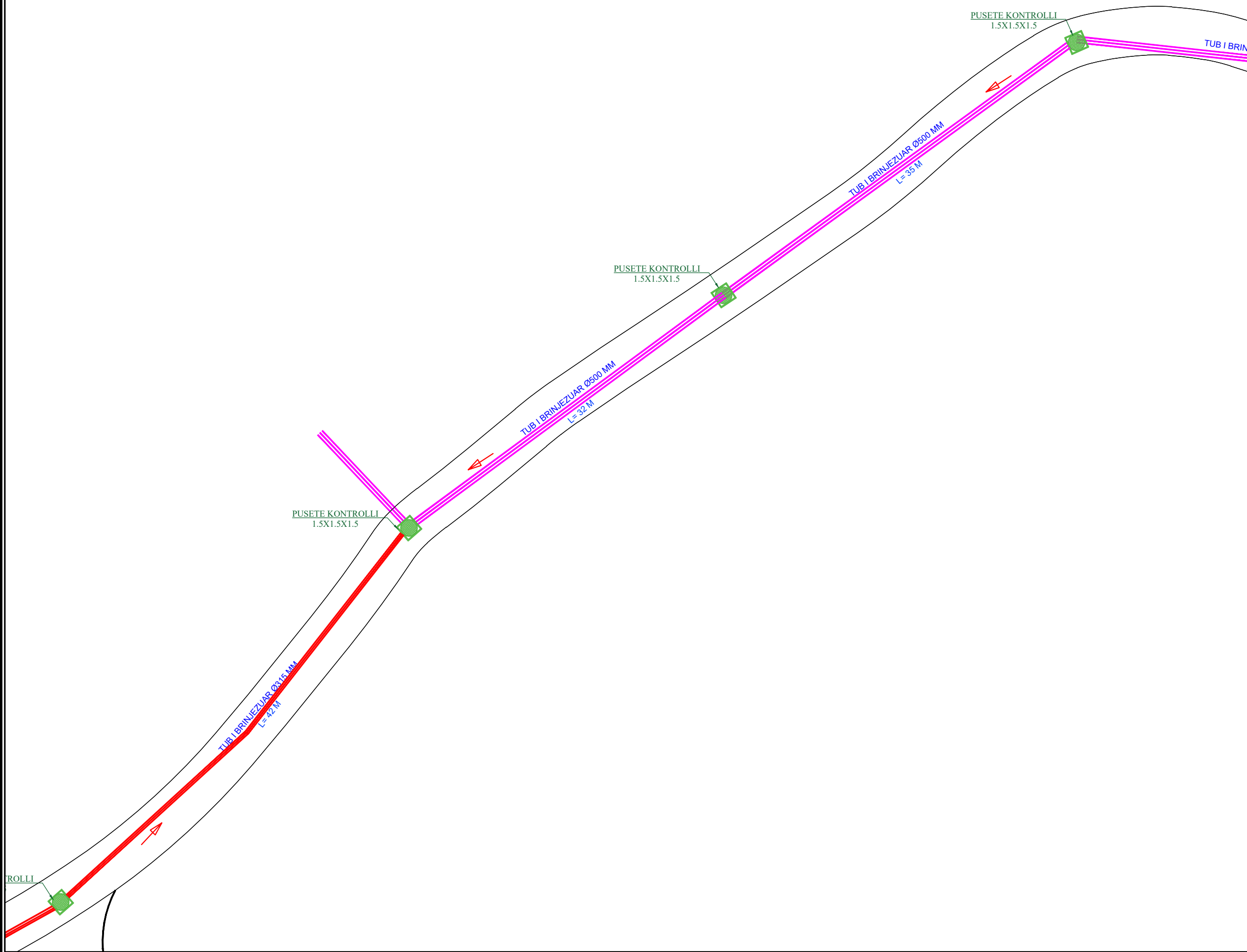



REPUBLIKA E SHQIPERISE
BASHKIA PATOS
DREJTORIA E PLANIFIKIMIT URBAN,
PROJEKTEVE, SHERBIMEVE DHE
EMERGJENCAVE CIVILE

EMERTIMI I PROJEKTIT:

**RIKONSTRUKSION I
RRUGES "LAGJJA E RE"
TEK PERROI CAM**

EMERTIMI I FLETES:

**PLANI I KANALIZIMEVE TE
UJRAVE**

GRUPI I PROJEKTIMIT:

ING. SILVANA MICI
ING.
ARK.
ING EL.

DREJTORIA E PLANIFIKIMIT
URBAN, PROJEKTEVE,
SHERBIMEVE DHE
EMERGJENCAVE CIVILE

ING. BORETA MURATI

SHKALLA

1:300

Fleta: NR 7

KORRIK 2023

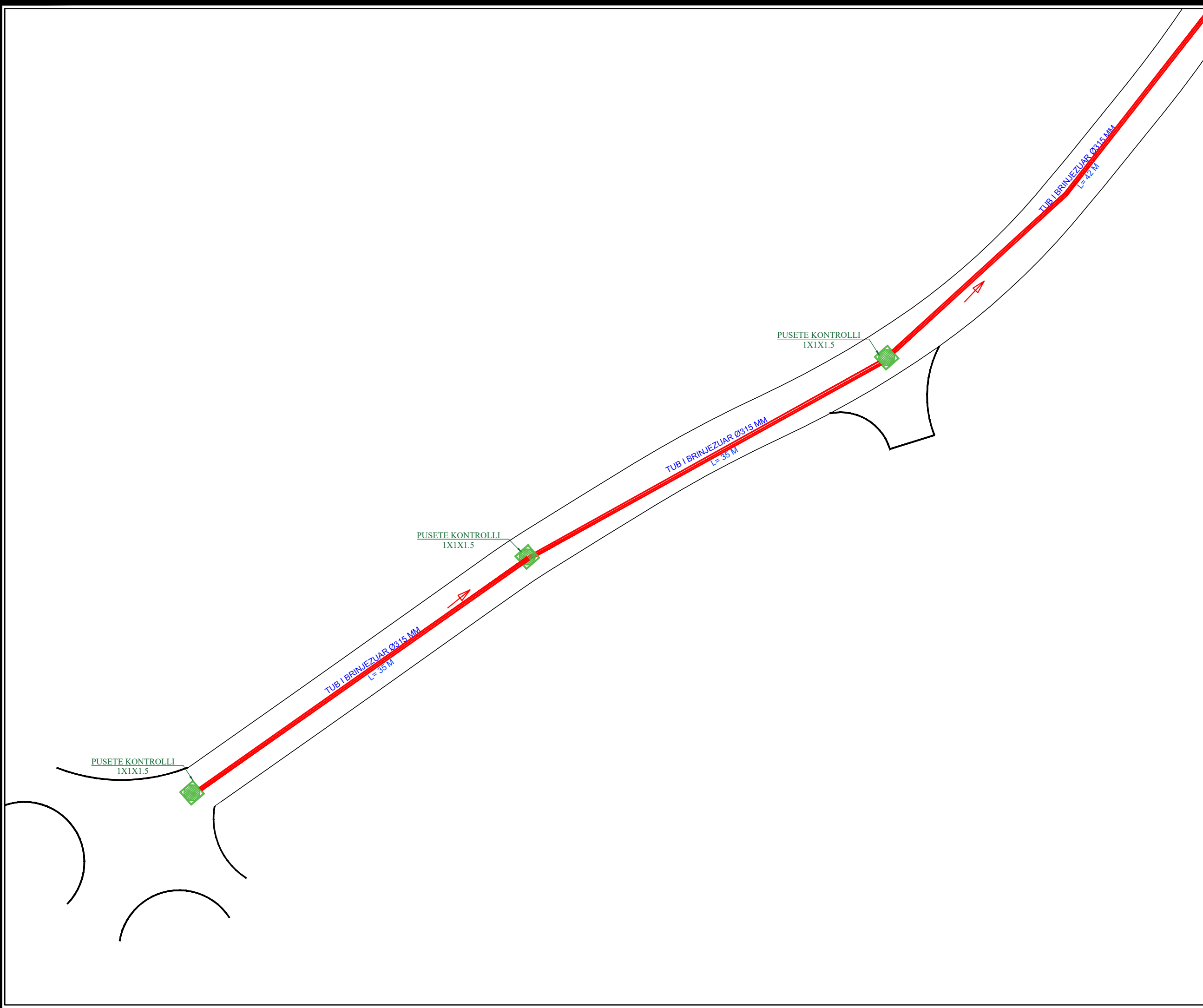



REPUBLIKA E SHQIPERISE
BASHKIA PATOS
DREJTORIA E PLANIFIKIMIT URBAN,
PROJEKTEVE, SHERBIMEVE DHE
EMERGJENCAVE CIVILE

EMERTIMI I PROJEKTIT:

**RIKONSTRUKSION I
RRUGES "LAGJJA E RE"
TEK PERROI CAM**

EMERTIMI I FLETES:

**PLANI I KANALIZIMEVE TE
UJRAVE**

GRUPI I PROJEKTIMIT:

ING. SILVANA MICI
ING.
ARK.
ING EL.

DREJTORIA E PLANIFIKIMIT
URBAN, PROJEKTEVE,
SHERBIMEVE DHE
EMERGJENCAVE CIVILE

ING. BORETA MURATI

SHKALLA

1:300

Fleta: NR 8

KORRIK 2023

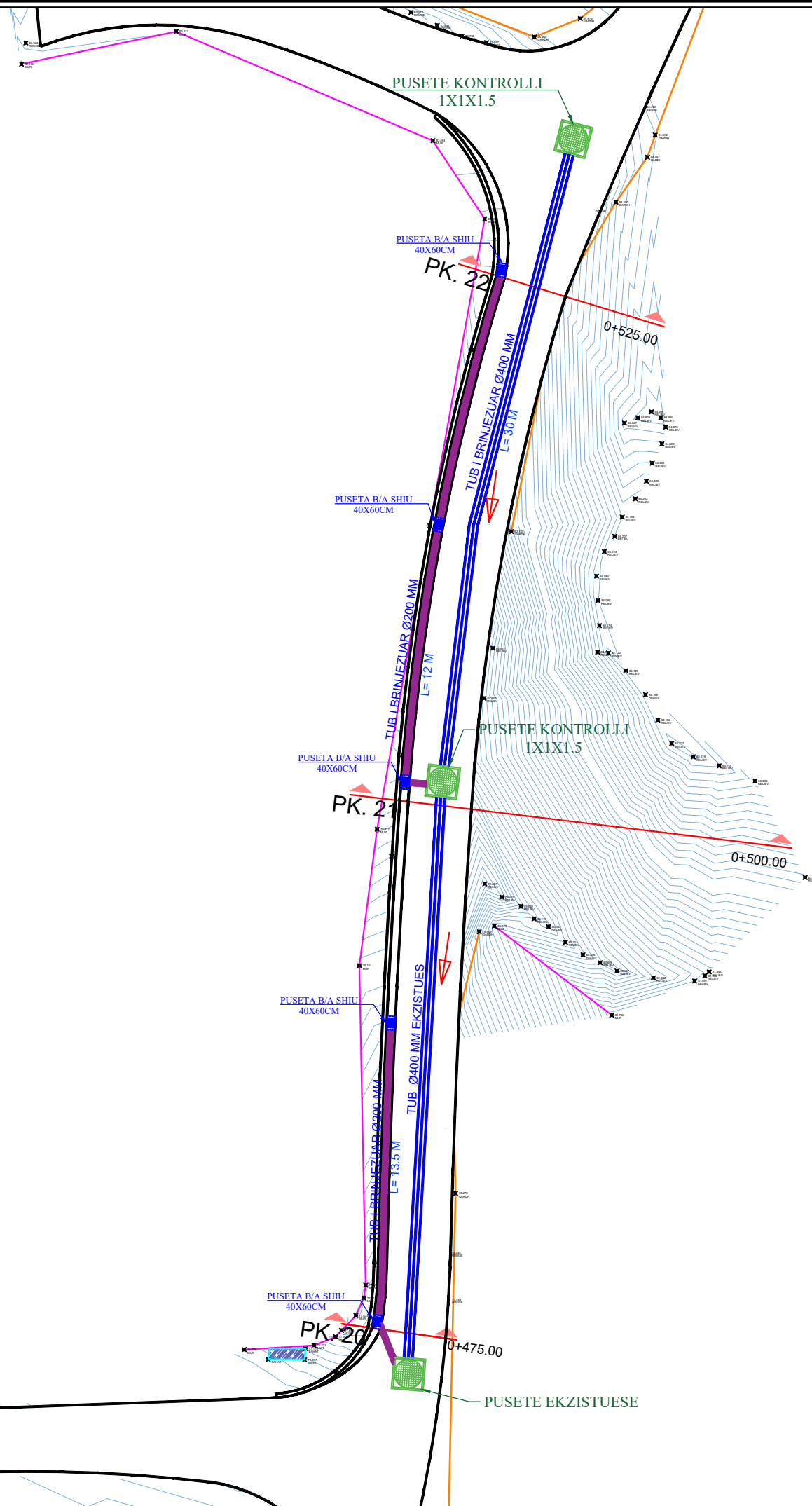



REPUBLIKA E SHQIPERISE
BASHKIA PATOS
DREJTORIA E PLANIFIKIMIT URBAN,
PROJEKTEVE, SHERBIMEVE DHE
EMERGJENCAVE CIVILE

EMERTIMI I PROJEKTIT:

**RIKONSTRUKSION I
RRUGES "LAGJJA E RE"
TEK PERROI CAM**

EMERTIMI I FLETES:

**SEKSIONI TERTHOR I
KANALIT PER PASTRIM**

GRUPI I PROJEKTIMIT:

ING. SILVANA MICI
ING.
ARK.
ING EL.

DREJTORIA E PLANIFIKIMIT
URBAN, PROJEKTEVE,
SHERBIMEVE DHE
EMERGJENCAVE CIVILE

ING. BORETA MURATI

SHKALLA

1:100

Fleta: NR 10

KORRIK 2023

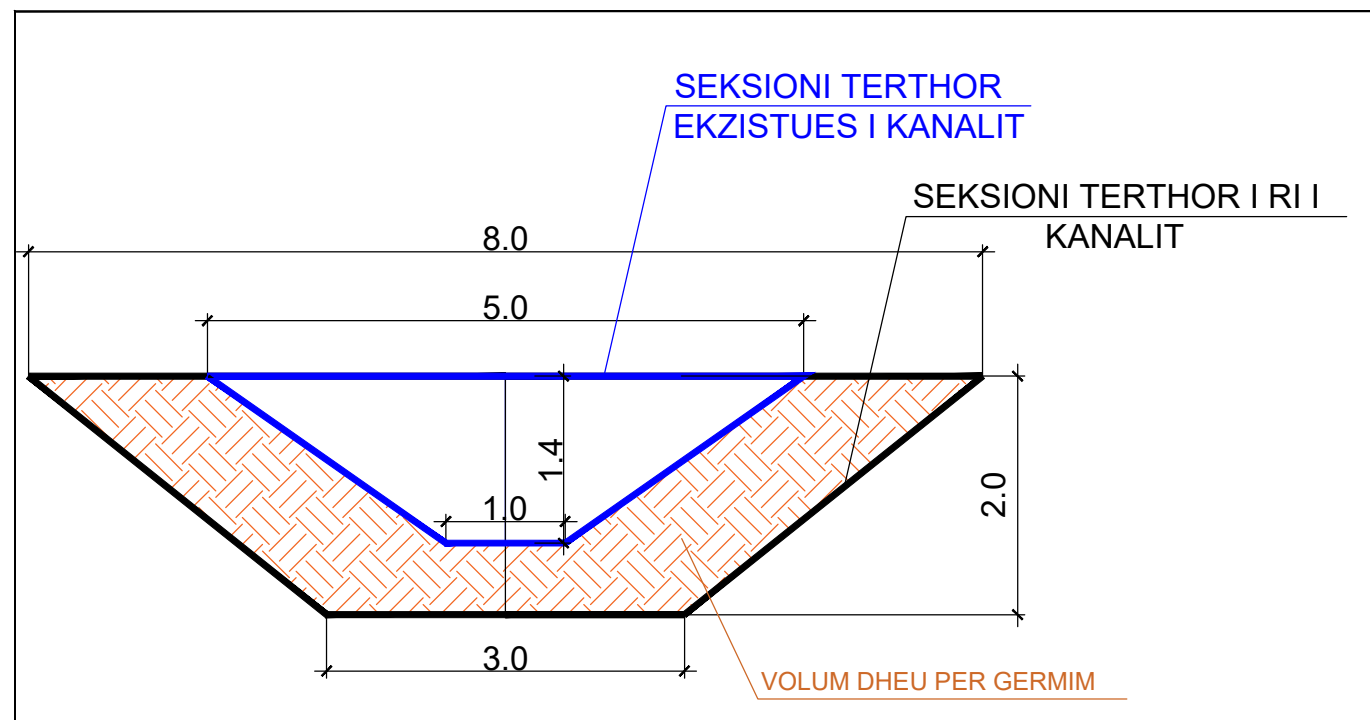



REPUBLIKA E SHQIPERISE
BASHKIA PATOS
DREJTORIA E PANIFIKIMIT URBAN, PROJEKTEVE, SHERBIMEVE DHE EMERGJENCAVE
CIVILE

OBJEKTI: RIKONSTRUKSION I RRUGES "LAGJJA E RE" TE PERROI ÇAM
STRUKTURAT

Nr. i fleteve: 4 (kater) flete

Grupi i Projektimit: **Ing. Silvana Mici**
Ark. Arlind Rusto

Drejtore :

Ing. Boreta MURATI

MIRATOHET
KRYETAR
FATION DURO

Korrik 2023

PRERJA GJATESORE E TOMBINOS Ø1500

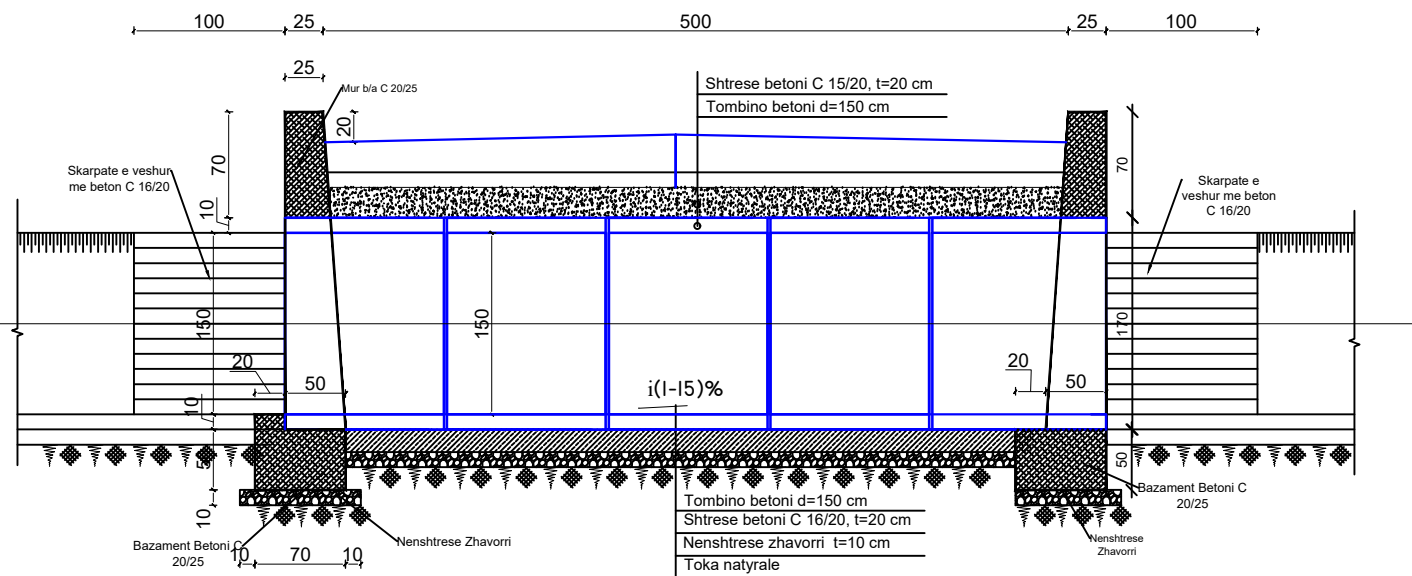

Prerje A-A

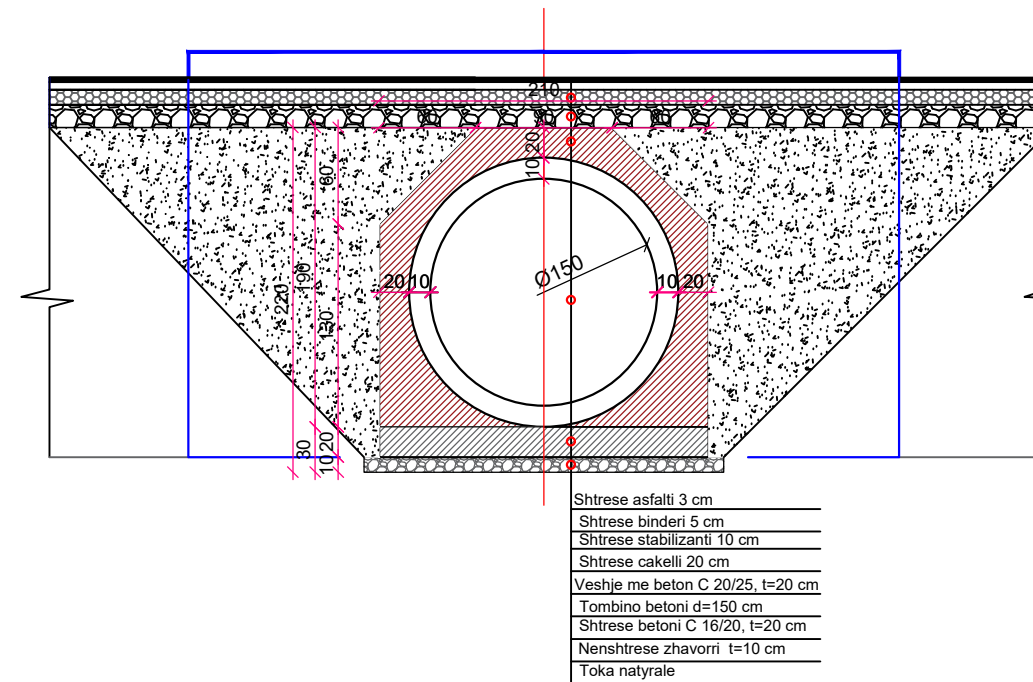

PLANIMETRIA E TOMBINOS Ø1500

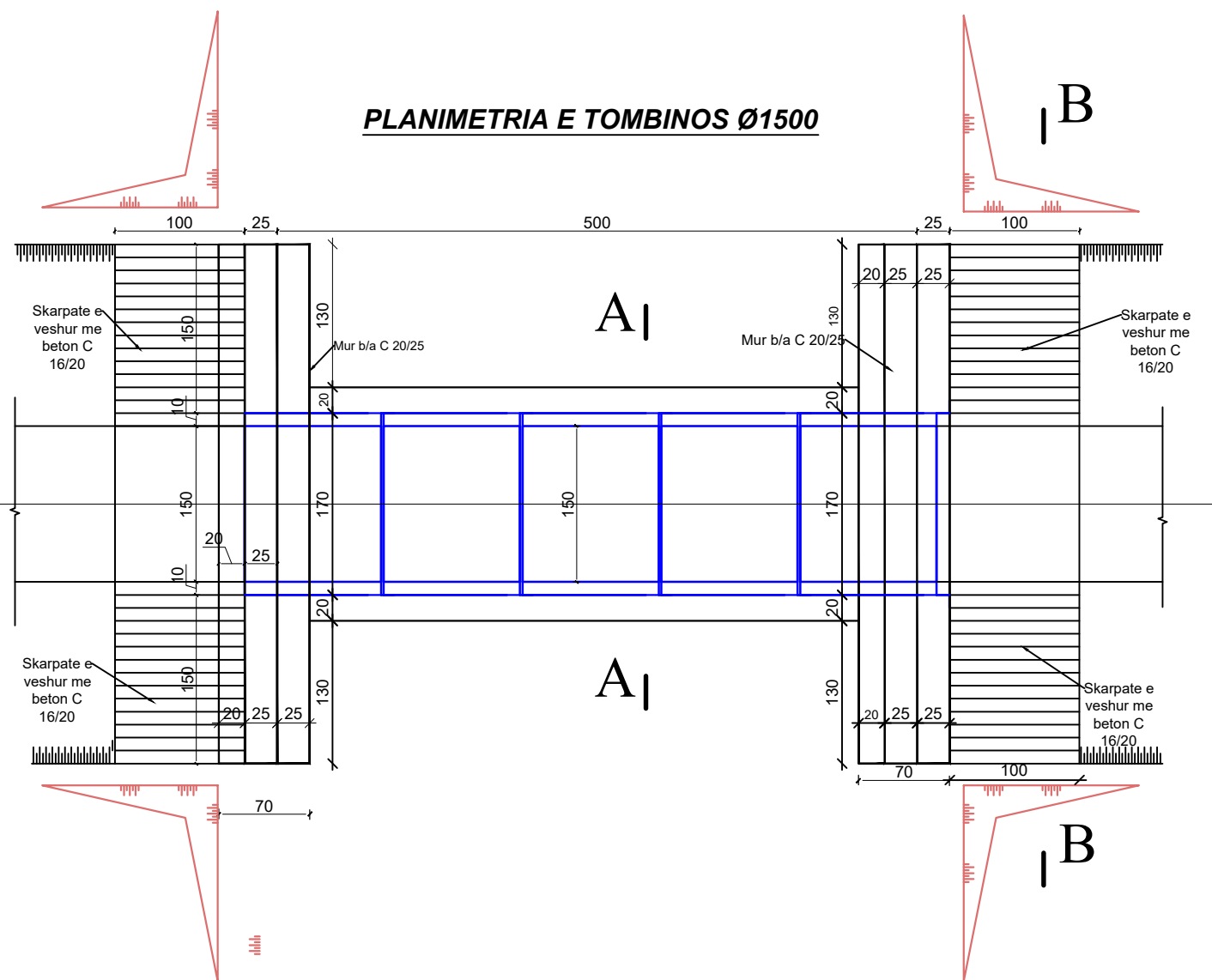

PRERJA B-B

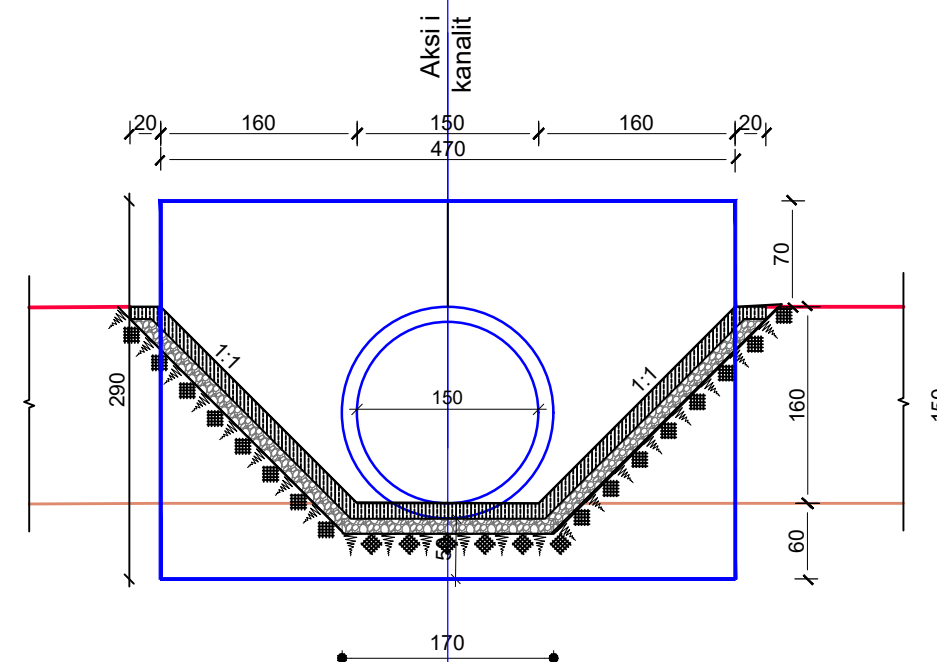

REPUBLIKA E SHQIPERISE
BASHKIA PATOS
DREJTORIA E PLANIFIKIMIT URBAN,
PROJEKTEVE, SHERBIMEVE DHE
EMERGJENCAVE CIVILE

EMERTIMI I PROJEKTIT:

**RIKONSTRUKSION I
RRUGES "LAGJJA E RE"
TEK PERROI CAM**

EMERTIMI I FLETES:

**PLANIMETRI DHE
PRERJE TE
STRUKTURES ME
TOMBINO Ø1500**

GRUPI I PROJEKTIMIT:

ING. SILVANA MICI
ING.
ARK.
ING EL.

DREJTORIA E PLANIFIKIMIT
URBAN, PROJEKTEVE,
SHERBIMEVE DHE
EMERGJENCAVE CIVILE

ING. BORETA MURATI

SHKALLA

1:50

Fleta: NR 1

KORRIK 2023

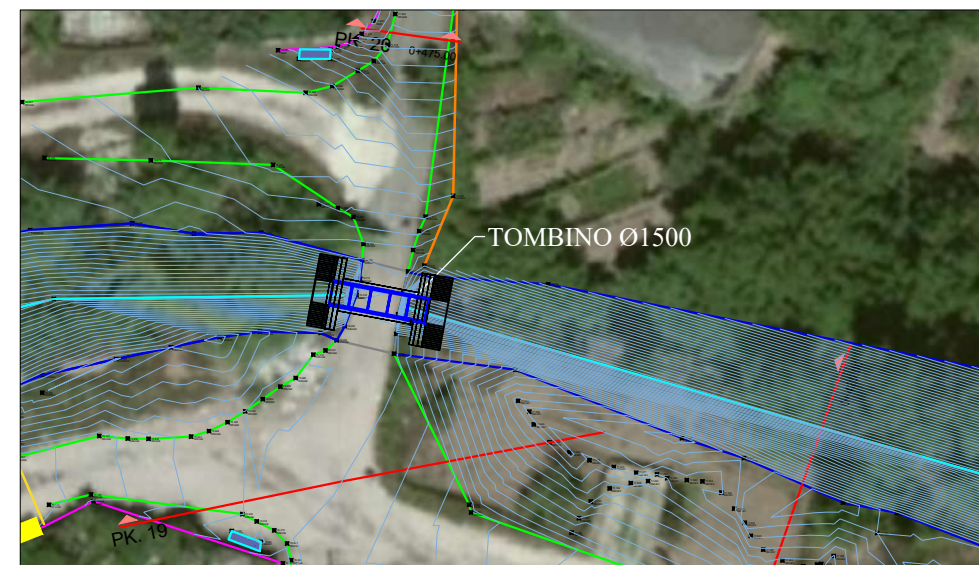

ARMIMI I MUREVE ANESORE B/A TE TOMBINOS Ø1500

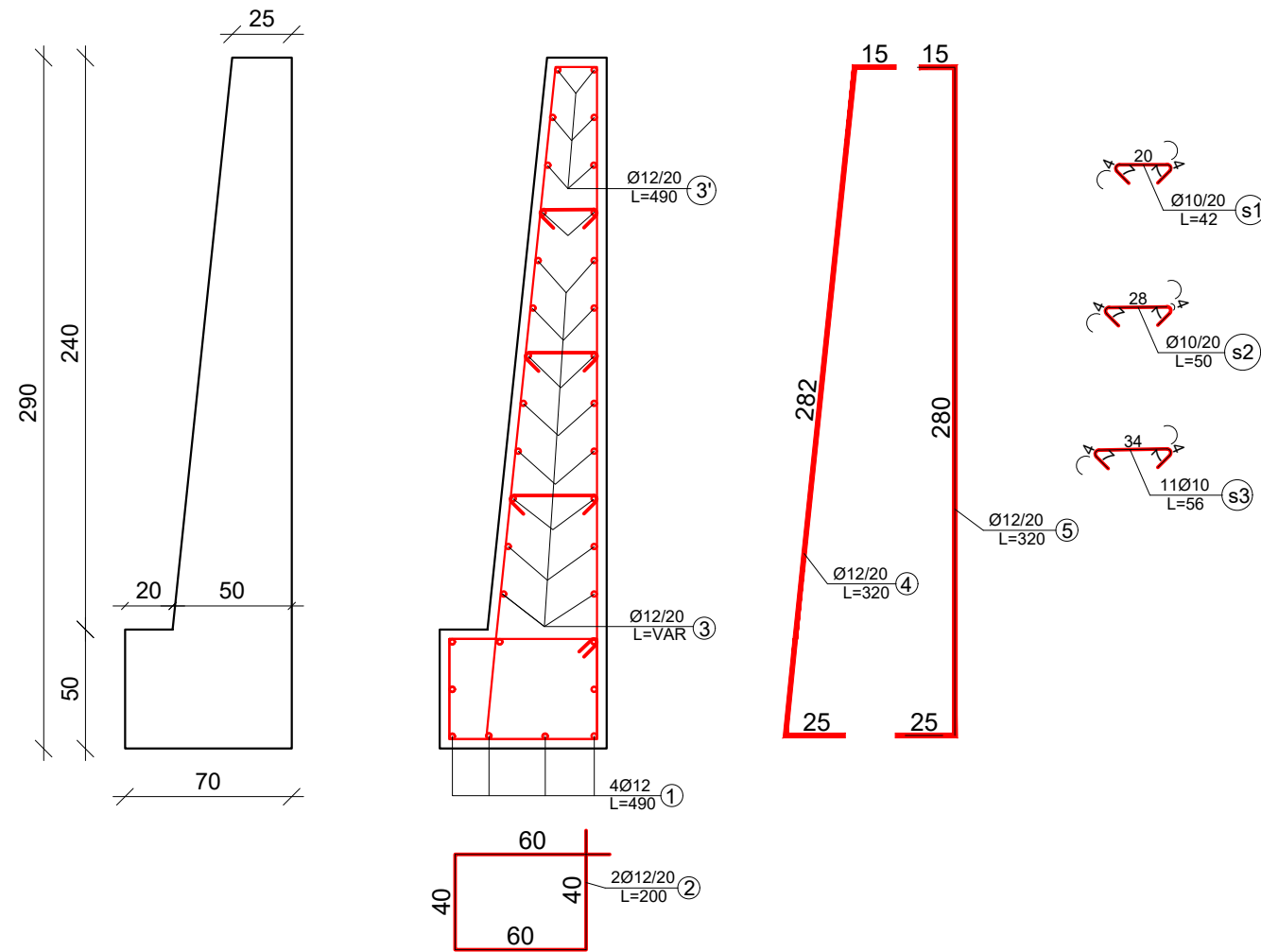

ARMIMI I MUREVE ANESORE B/A TE TOMBINOS Ø1500

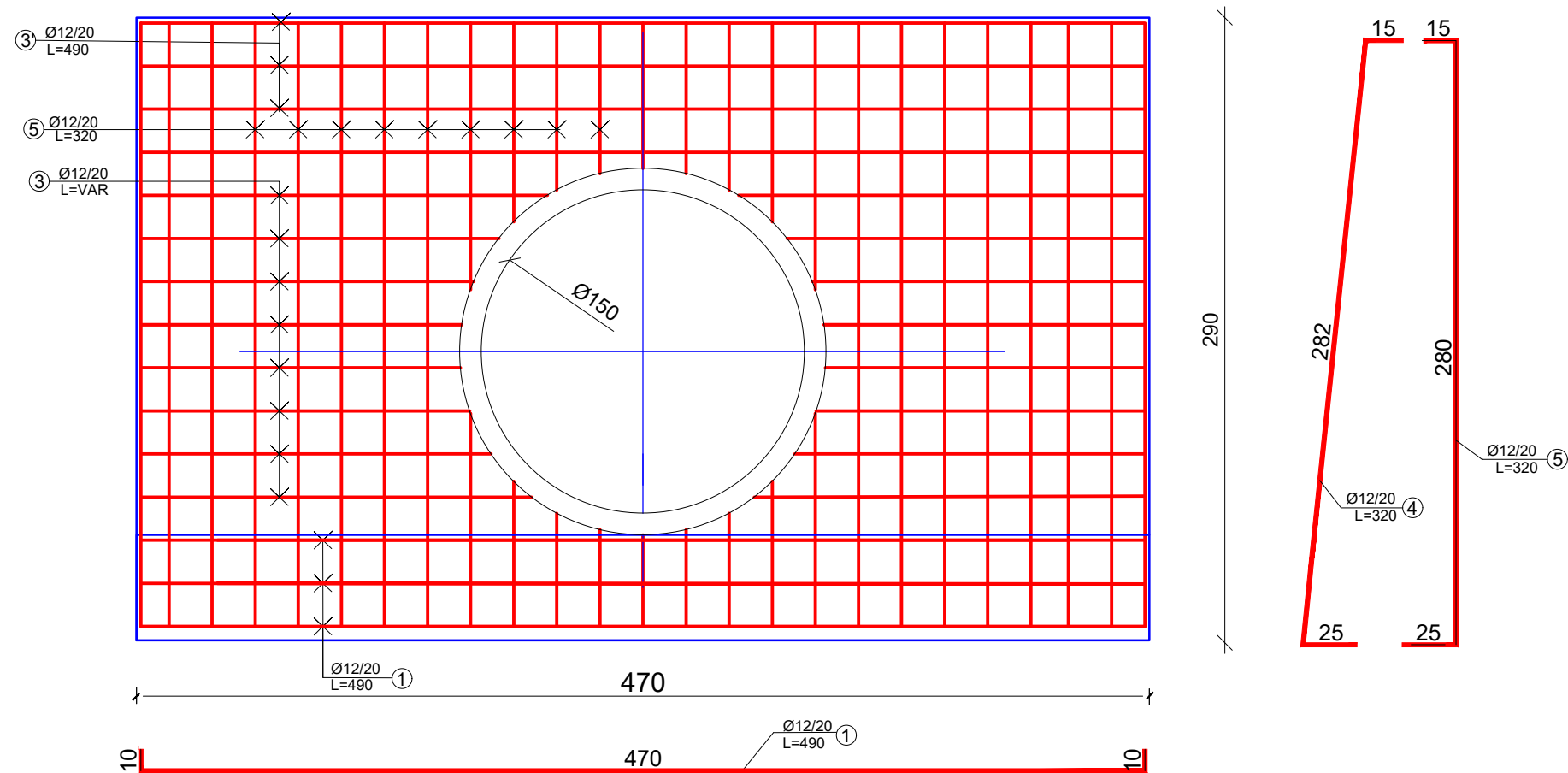

REPUBLIKA E SHQIPERISE
BASHKIA PATOS
DREJTORIA E PLANIFIKIMIT URBAN,
PROJEKTEVE, SHERBIMEVE DHE
EMERGJENCAVE CIVILE

EMERTIMI I PROJEKTIT:

**RIKONSTRUKSION I
RRUGES "LAGJJA E RE"
TEK PERROI CAM**

EMERTIMI I FLETES:

**PARMIMI I
STRUKTURES ME
TOMBINO Ø1500**

GRUPI I PROJEKTIMIT:

ING. SILVANA MICI
ING.
ARK.
ING EL.

DREJTORIA E PLANIFIKIMIT
URBAN, PROJEKTEVE,
SHERBIMEVE DHE
EMERGJENCAVE CIVILE

ING. BORETA MURATI

SHKALLA

1:30

Fleta: NR 2

KORRIK 2023



REPUBLIKA E SHQIPERISE
BASHKIA PATOS
DREJTORIA E PLANIFIKIMIT URBAN,
PROJEKTEVE, SHERBIMEVE DHE
EMERGJENCAVE CIVILE

EMERTIMI I PROJEKTIT:

**RIKONSTRUKSION I
RRUGES "LAGJJA E RE"
TEK PERROI CAM**

EMERTIMI I FLETES:

**PLANIMETRI DHE
PRERJE TE
STRUKTURES ME
TOMBINO Ø600**

GRUPI I PROJEKTIMIT:

ING. SILVANA MICI
ING.
ARK.
ING EL.

DREJTORIA E PLANIFIKIMIT
URBAN, PROJEKTEVE,
SHERBIMEVE DHE
EMERGJENCAVE CIVILE

ING. BORETA MURATI

SHKALLA

1:40

Fleta: NR 3

KORRIK 2023

TOMBINO Ø600

PRERJE GJATESORE NE AKS TE TOMBINOS Ø 600 mm

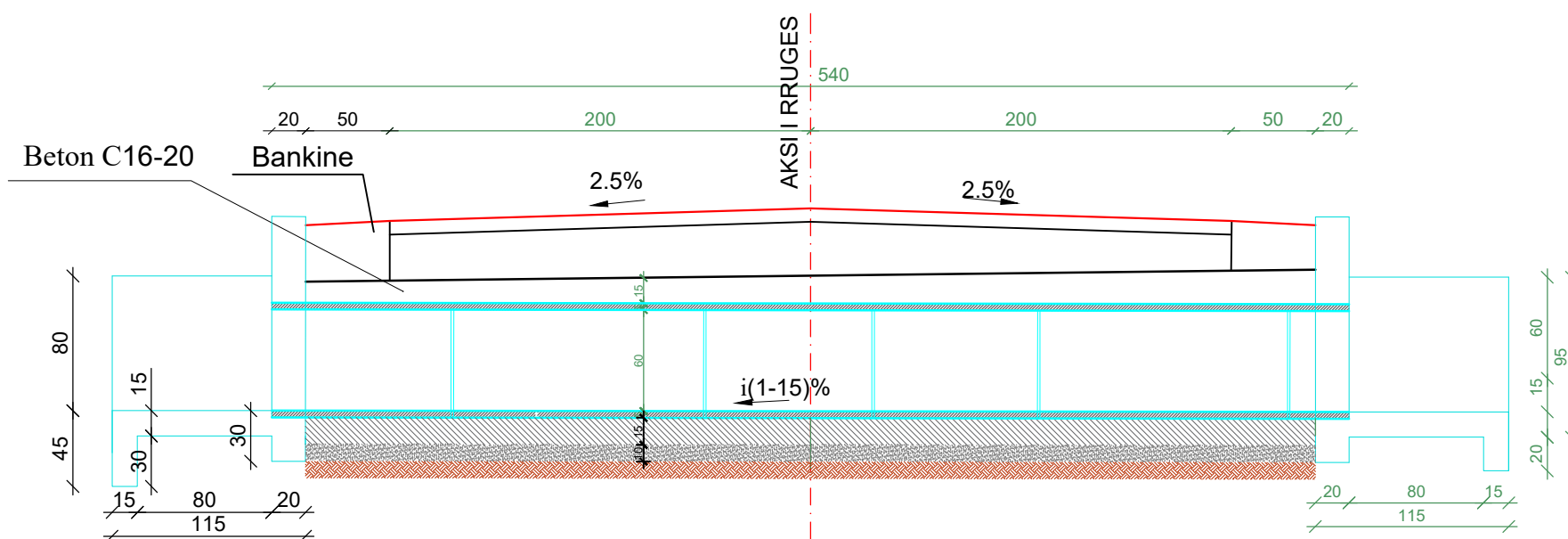

PLANIMETRIA E TOMBINOS
(PAMJE NGA LART)

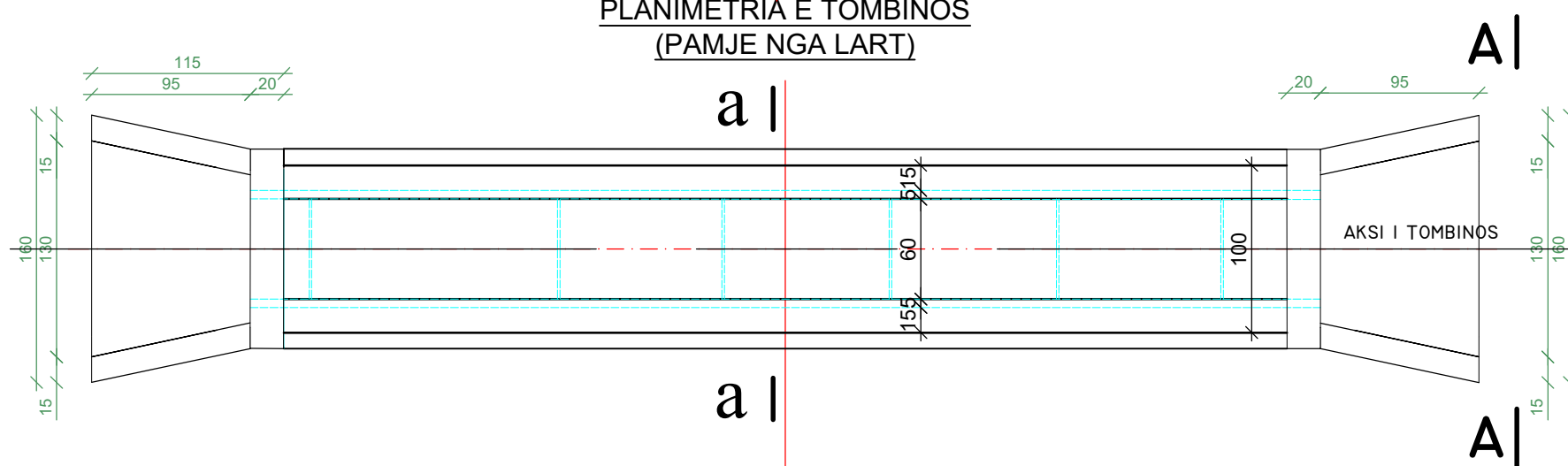

PAMJE A - A

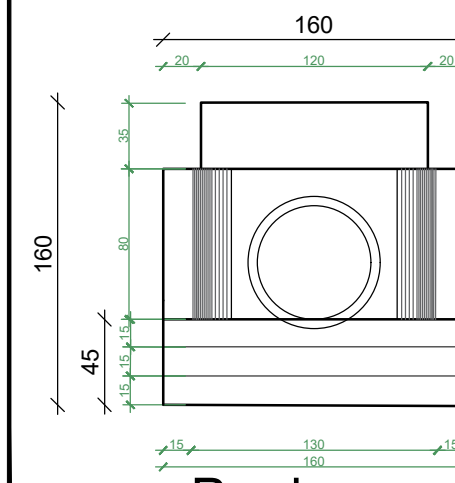

Prerje a-a

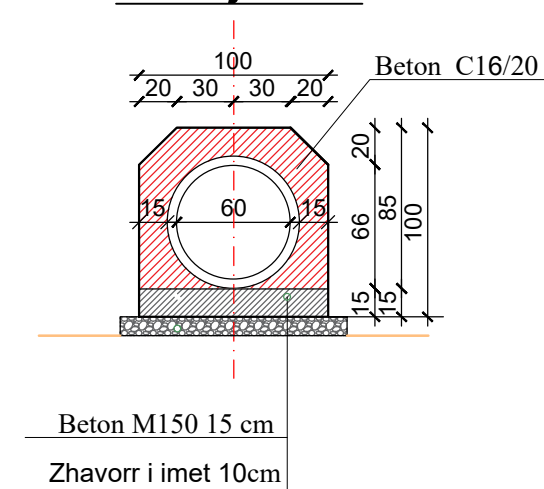



REPUBLIKA E SHQIPERISE
 BASHKIA PATOS
 DREJTORIA E PLANIFIKIMIT URBAN,
 PROJEKTEVE, SHERBIMEVE DHE
 EMERGJENCAVE CIVILE

EMERTIMI I PROJEKTIT:

**RIKONSTRUKSION I
 RRUGES "LAGJJA E RE"
 TEK PERROI CAM**

EMERTIMI I FLETES:

**ARMIMI I STRUKTURES
 ME TOMBINO Ø600**

GRUPI I PROJEKTIMIT:

ING. SILVANA MICI
 ING.
 ARK.
 ING EL.

DREJTORIA E PLANIFIKIMIT
 URBAN, PROJEKTEVE,
 SHERBIMEVE DHE
 EMERGJENCAVE CIVILE

ING. BORETA MURATI

SHKALLA

1:30

Fleta: NR 4

KORRIK 2023

PLANIMETRI

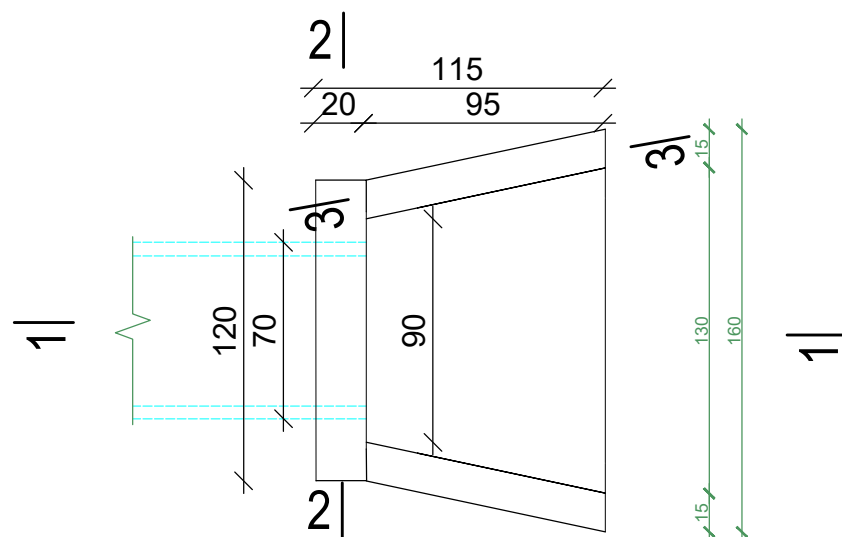

PRERJE 1-1 sh.1:50

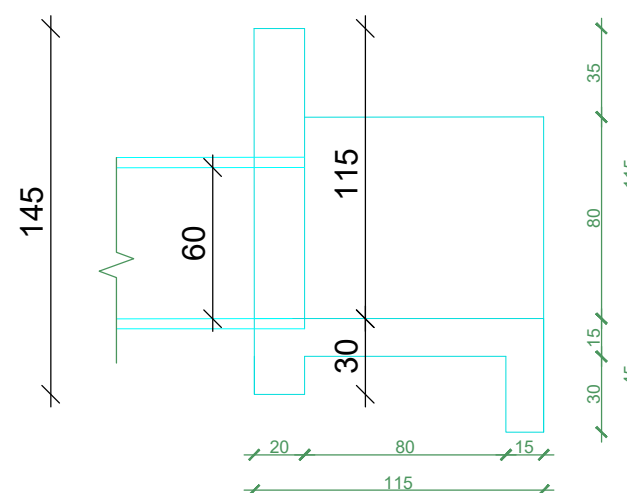

PRERJE 1-1

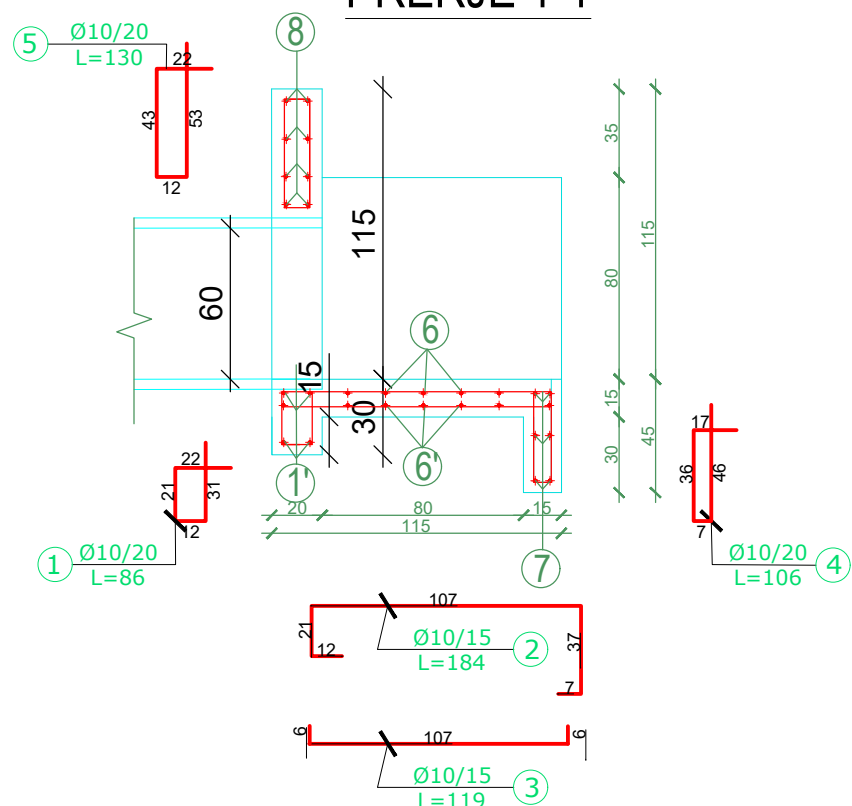

PRERJE 2-2

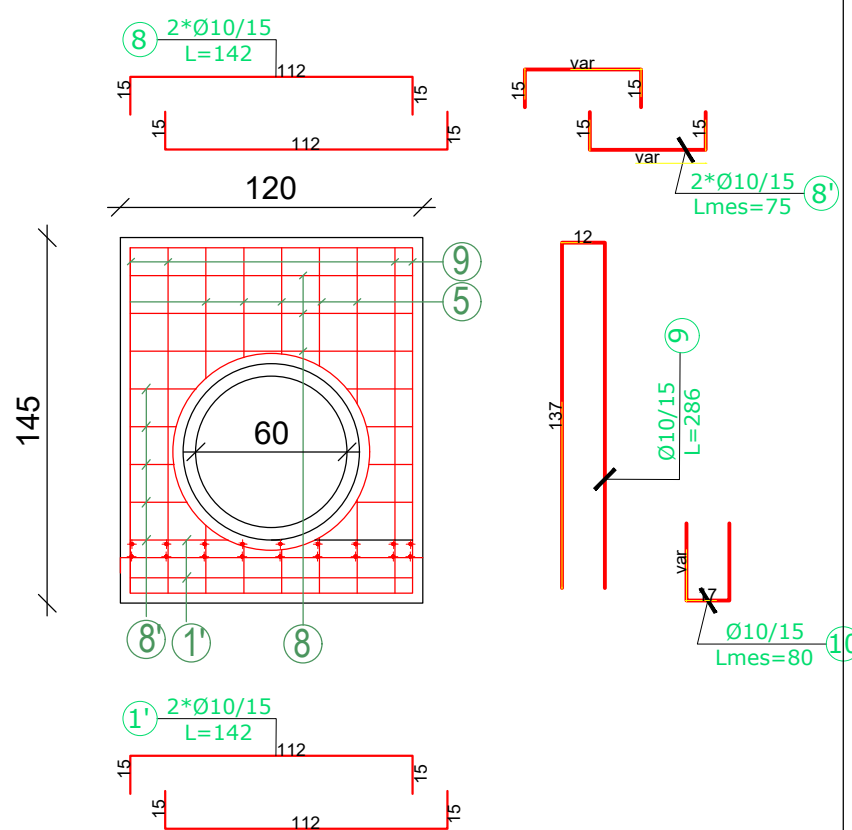

**PRERJE 3-3
 (2 cope)**

